

May 2022

PowerLyzer[®] 24 Homogenizer User Manual

For lysis and homogenization of biological samples contained in bead beating tubes at variable speeds



Contents

Safety Information.....	5
Proper use	6
Biological safety.....	7
Samples	7
Toxic fumes	9
Waste disposal	9
Mechanical hazards	9
Symbols on the PowerLyzer 24 Homogenizer	10
Translations of warnings and cautions.....	10
Introduction.....	23
Intended use of the PowerLyzer 24 Homogenizer	23
Requirements for PowerLyzer 24 Homogenizer users	23
General Description	24
Features of the PowerLyzer 24 Homogenizer system	24
Installation Procedures	24
Parts	24
Unpacking the PowerLyzer 24 Homogenizer	25
Installation	28
Transport.....	30
Transporting the PowerLyzer 24 Homogenizer	30
Decontamination	31
Operating Procedures	32

Tube motion.....	32
Programming	33
Keypad layout.....	33
Startup of the equipment	34
Loading sample tubes	36
Program settings.....	38
Adjusting parameters	40
Adjusting the speed	40
Adjusting the run time	41
Adjusting the number of cycles.....	41
Adjusting the pause or “dwell” between cycles	42
Recommended settings	44
Homogenizer speed conversion table	45
Maintenance Procedures	46
Regular maintenance	46
Replacing the fuse(s)	46
Cleaning and decontamination	47
Decontamination procedure.....	48
Troubleshooting Guide	49
General troubleshooting	49
Appendix A	50
Technical data	50
Environmental conditions.....	50
Operating conditions.....	50

Storage conditions	50
Mechanical data	50
Waste Electrical and Electronic Equipment (WEEE).....	51
FCC declaration	52
Declaration of Conformity.....	53
Appendix B.....	54
Warranty statement	54
Liability clause	55
Appendix C	56
Decontamination certificate	56

Safety Information

Before using the PowerLyzer 24 Homogenizer system, it is essential that you read this user manual carefully and pay particular attention to the safety information. The instructions and safety information in the user manual must be followed to ensure safe operation of the PowerLyzer 24 Homogenizer and to maintain the PowerLyzer 24 Homogenizer in a safe condition.

The following types of safety information appear throughout this user manual.

<p>WARNING</p> 	<p>The term WARNING is used to inform you about situations that could result in personal injury to you or other persons.</p> <p>Details about these circumstances are given in a box like this one.</p>
---	--

<p>CAUTION</p> 	<p>The term CAUTION is used to inform you about situations that could result in damage to the PowerLyzer 24 or other equipment.</p> <p>Details about these circumstances are given in a box like this one.</p>
---	---

Each warning (W) or caution (C) can be identified by a reference number mentioned at the top right corner of their respective boxes (e.g., [W1], [C1], etc.).

The advice given in this manual is intended to supplement, not supersede, the normal safety requirements prevailing in the user's country.

Proper use

<p>WARNING</p> 	<p style="text-align: right;">[W1]</p> <p>Electrical hazard</p> <p>Any interruption of the protective conductor (earth/ground lead) inside or outside the PowerLyzer 24 Homogenizer or disconnection of the protective conductor terminal is likely to make the PowerLyzer 24 Homogenizer dangerous.</p> <p>Intentional interruption is prohibited.</p> <p>Lethal voltages inside the PowerLyzer 24 Homogenizer</p> <p>When the PowerLyzer 24 Homogenizer is connected to line power, terminals may be live, and opening the PowerLyzer 24 Homogenizer or removing parts is likely to expose live parts.</p>
---	---

The PowerLyzer 24 Homogenizer should only be used for the applications described in the *PowerLyzer 24 Homogenizer User Manual*.

Perform the maintenance as described in "Maintenance Procedures," page 46. QIAGEN charges for repairs that are required due to incorrect maintenance.

To ensure satisfactory and safe operation of the PowerLyzer 24 Homogenizer, follow the advice below:

- Do not allow the machine to be submerged in any liquid.
- Do not use in any setting other than an indoor laboratory.
- Use this product only for its intended purpose as described in this manual. Do not use attachments not recommended by the manufacturer.
- Check that the proper power cord is plugged into the correct outlet and that the voltage selection switch located on the back of the unit has been selected to the correct voltage for your country.
- Do not operate the product if it is damaged in any way.

-
- Keep this product away from heated surfaces.
 - Do not attempt to modify any part of the PowerLyzer 24 Homogenizer.
 - Do not turn the unit upside down: the PowerLyzer 24 Homogenizer must always rest on all four feet to avoid damaging internal components or breaking the housing.
 - Do not operate the unit when the housing is removed; potentially lethal voltage exists within the instrument.
 - Do not operate the unit with the safety ground disconnected.
 - Do not overfill the tubes as this may lead to liquid contamination and compromise the safety of the unit.

Biological safety

When handling biological material, use safe laboratory procedures as outlined in publications such as *Biosafety in Microbiological and Biomedical Laboratories*, HHS www.cdc.gov/od/ohs/biosfty/biosfty.htm.

Samples

Samples may contain infectious agents. You should be aware of the health hazard presented by such agents and should use, store and dispose of such samples according to the required safety regulations.

<p>WARNING</p> 	<p style="text-align: right;">[W2]</p> <p>Samples containing infectious agents</p> <p>Some samples used with the PowerLyzer 24 Homogenizer may contain infectious agents. Handle such samples with the greatest of care and in accordance with the required safety regulations.</p> <p>Always wear safety glasses, 2 pairs of gloves and a lab coat.</p> <p>The responsible body (e.g., laboratory manager) must take the necessary precautions to ensure that the surrounding workplace is safe, and that PowerLyzer 24 operators are suitably trained and not exposed to hazardous levels of infectious agents as defined in the applicable Safety Data Sheets (SDSs) or OSHA,* ACGIH† or COSHH‡ documents.</p> <p>Venting for fumes and disposal of wastes must be in accordance with all national, state and local health and safety regulations and laws.</p>
---	--

*OSHA: Occupational Safety and Health Administration (United States of America).

†ACGIH: American Conference of Government Industrial Hygienists (United States of America).

‡COSHH: Control of Substances Hazardous to Health (United Kingdom).

Chemicals

<p>WARNING</p> 	<p style="text-align: right;">[W3]</p> <p>Hazardous chemicals</p> <p>Some chemicals used with the PowerLyzer 24 Homogenizer may be hazardous or may become hazardous after completion of the sample disruption process.</p> <p>Always wear safety glasses, gloves and a lab coat.</p> <p>The responsible body (e.g., laboratory manager) must take the necessary precautions to ensure that the surrounding workplace is safe and that PowerLyzer 24 Homogenizer operators are not exposed to hazardous levels of toxic substances (chemical or biological) as defined in the applicable Safety Data Sheets (SDSs) or OSHA,* ACGIH† or COSHH‡ documents.</p> <p>Venting for fumes and disposal of wastes must be in accordance with all national, state and local health and safety regulations and laws.</p>
---	---

*OSHA: Occupational Safety and Health Administration (United States of America).

†ACGIH: American Conference of Government Industrial Hygienists (United States of America).

‡COSHH: Control of Substances Hazardous to Health (United Kingdom).

Toxic fumes

If working with volatile solvents, toxic substances, etc., you must provide an efficient laboratory ventilation system to remove vapors that may be produced.

WARNING 	Toxic fumes [W4] Do not use bleach to clean or disinfect used labware. Bleach in contact with salts from the buffers used can produce toxic fumes.
---	--







Waste disposal

Used labware, such as sample tubes, may contain hazardous chemicals or infectious agents from the sample disruption process. Such wastes must be collected and disposed of properly according to local safety regulations. For information on how to dispose of the PowerLyzer 24 Homogenizer, see Appendix A (page 51).

Mechanical hazards

WARNING 	Moving parts [W5] Avoid contact with moving parts during operation of the PowerLyzer 24 Homogenizer.
---	--

Symbols on the PowerLyzer 24 Homogenizer

Symbol	Location	Description
	Type plate on the back of the instrument	CE mark for European Conformity
	Type plate on the back of the instrument	Legal manufacturer
	Type plate on the back of the instrument	Serial number
	Type plate on the back of the instrument	Waste Electrical and Electronic Equipment (WEEE) mark for Europe
	Type plate on the back of the instrument	FCC mark of the United States Federal Communications Commission
	Type plate on the back of the instrument	RCM mark for Australia/New Zealand
	Type plate on the back of the instrument	RoHS mark for China (the restriction of the use of certain hazardous substances in electrical and electronic equipment)

Translations of warnings and cautions

This subsection contains translations of the warnings and cautions used in this user manual. Each warning or caution has a reference number in square brackets at the top right of its box.

<p>WARNING</p> 	<p>The term WARNING is used to inform you about situations that could result in personal injury to you or other persons.</p> <p>Details about these circumstances are given in a box like this one.</p>
---	--

DE	<p>WARNING (WARNUNG)</p> <p>Warnung weist auf Situationen und Umstände hin, die zu einer Verletzung des Benutzers oder anderer Personen führen können. Nähere Angaben zu der Art der Gefährdung und der Vermeidung solcher Situationen werden in einem Textfeld wie diesem neben der Warnung gemacht.</p>
FR	<p>WARNING (DANGER)</p> <p>La formule WARNING (DANGER) est utilisée pour avertir des situations pouvant occasionner des dommages corporels à l'utilisateur ou à d'autres personnes. Les détails sur ces circonstances sont données dans un encadré semblable à celui-ci.</p>

<p>WARNING</p> 	<p>Electrical hazard [W1]</p> <p>Any interruption of the protective conductor (earth/ground lead) inside or outside the PowerLyzer 24 Homogenizer or disconnection of the protective conductor terminal is likely to make the PowerLyzer 24 Homogenizer dangerous.</p> <p>Intentional interruption is prohibited.</p> <p>Lethal voltages inside the PowerLyzer 24 Homogenizer</p> <p>When the PowerLyzer 24 Homogenizer is connected to line power, terminals may be live, and opening the PowerLyzer 24 Homogenizer or removing parts is likely to expose live parts.</p>
DE	<p>Gefahr durch Stromschlag</p> <p>Jede Unterbrechung des Schutzleiters (Erdungs- bzw. Masseleiter) im PowerLyzer 24 Homogenizer oder außerhalb des Geräts und jede Abtrennung des Schutzleiters am Anschluss der Netzleitung erhöht die Gefahr eines Stromschlags.</p> <p>Eine absichtliche Unterbrechung der Schutzleiterverbindung ist verboten.</p> <p>Gefährliche Spannung im PowerLyzer 24 Homogenizer</p> <p>Wenn der PowerLyzer 24 Homogenizer an die Stromversorgung angeschlossen ist, können die Anschlussstellen spannungsführend sein. Durch das Öffnen des PowerLyzer 24 Homogenizer oder das Entfernen von Teilen können spannungsführende Komponenten freigelegt werden.</p>

FR	<p>Danger électrique</p> <p>Toute interruption du conducteur de protection (conducteur de terre/de masse) à l'intérieur ou à l'extérieur du PowerLyzer 24 Homogenizer ou toute déconnexion de la borne du conducteur de protection est susceptible de rendre le PowerLyzer 24 Homogenizer dangereux.</p> <p>Toute interruption intentionnelle est interdite.</p> <p>Tensions mortelles à l'intérieur du PowerLyzer 24 Homogenizer</p> <p>Lorsque le PowerLyzer 24 Homogenizer est relié à l'alimentation, les bornes peuvent être sous tension et l'ouverture du PowerLyzer 24 Homogenizer ou le retrait de pièces risque d'exposer des éléments sous tension.</p>
----	--

<p>WARNING</p> 	<p>Samples containing infectious agents [W2]</p> <p>Some samples used with the PowerLyzer 24 Homogenizer may contain infectious agents. Handle such samples with the greatest of care and in accordance with the required safety regulations.</p> <p>Always wear safety glasses, 2 pairs of gloves and a lab coat.</p> <p>The responsible body (e.g., laboratory manager) must take the necessary precautions to ensure that the surrounding workplace is safe, and that PowerLyzer 24 Homogenizer operators are suitably trained and not exposed to hazardous levels of infectious agents as defined in the applicable Safety Data Sheets (SDSs) or OSHA,* ACGIH† or COSHH‡ documents.</p> <p>Venting for fumes and disposal of wastes must be in accordance with all national, state and local health and safety regulations and laws.</p>
---	---

DE	<p>Proben mit Infektionserregern</p> <p>Proben, die mit dem PowerLyzer 24 Homogenisator behandelt werden, können Infektionserreger enthalten. Gehen Sie beim Umgang mit diesen Proben mit der größtmöglichen Vorsicht und gemäß den erforderlichen Sicherheitsbestimmungen vor.</p> <p>Tragen Sie immer eine Schutzbrille, zwei Paar Laborhandschuhe und einen Laborkittel.</p> <p>Die verantwortliche Person (z. B. der Laborleiter) muss alle erforderlichen Vorsichtsmaßnahmen treffen, um sicherzustellen, dass die unmittelbare Umgebung des Arbeitsplatzes sicher ist und die Bediener des PowerLyzer 24 Homogenisators ausreichend geschult sind. Außerdem dürfen die Grenzwerte in Bezug auf Infektionserreger, die in den entsprechenden Sicherheitsdatenblättern (SDS) oder den Vorschriften der OSHA*, ACGIH† oder COSHH‡ festgelegt sind, nicht überschritten werden.</p> <p>Beim Betrieb eines Abzugs und bei der Entsorgung von Abfallstoffen müssen alle Bestimmungen und Gesetze auf Bundes-, Landes- und kommunaler Ebene zu Gesundheitsschutz und Sicherheit am Arbeitsplatz eingehalten werden.</p>
FR	<p>Échantillons contenant des agents infectieux</p> <p>Certains échantillons utilisés avec l'homogénéisateur PowerLyzer 24 peuvent contenir des agents infectieux. Manipuler ces échantillons avec la plus grande précaution et conformément aux règles de sécurité nécessaires.</p> <p>Toujours porter des lunettes de protection, 2 paires de gants et une blouse de laboratoire.</p> <p>La personne responsable (par exemple, le directeur du laboratoire) doit prendre les précautions nécessaires afin de garantir que le lieu de travail environnant est sûr et que les opérateurs de l'homogénéisateur PowerLyzer 24 sont convenablement formés et ne sont pas exposés à des niveaux dangereux d'agents infectieux comme cela est défini dans les fiches de données de sécurité (FDS) ou dans les documents de l'OSHA *, de l'ACGIH † ou du COSHH ‡ applicables.</p> <p>L'évacuation des vapeurs et la mise au rebut des déchets doivent s'effectuer conformément à toutes les réglementations et lois nationales, régionales et locales relatives à la santé et à la sécurité.</p>

*OSHA: Occupational Safety and Health Administration (United States of America).

†ACGIH: American Conference of Government Industrial Hygienists (United States of America).

‡COSHH: Control of Substances Hazardous to Health (United Kingdom).

<p>WARNING</p> 	<p style="text-align: right;">[W3]</p> <p>Hazardous chemicals</p> <p>Some chemicals used with the PowerLyzer 24 Homogenizer may be hazardous or may become hazardous after completion of the sample disruption process.</p> <p>Always wear safety glasses, gloves and a lab coat.</p> <p>The responsible body (e.g., laboratory manager) must take the necessary precautions to ensure that the surrounding workplace is safe and that PowerLyzer 24 Homogenizer operators are not exposed to hazardous levels of toxic substances (chemical or biological) as defined in the applicable Safety Data Sheets (SDSs) or OSHA,* ACGIH† or COSHH‡ documents.</p> <p>Venting for fumes and disposal of wastes must be in accordance with all national, state, and local health and safety regulations and laws.</p>
<p>DE</p>	<p>Gefahrstoffe</p> <p>Einige Chemikalien, die mit dem PowerLyzer 24 Homogenisator verwendet werden, können gefährlich sein oder nach dem Probenaufschluss gefährlich werden.</p> <p>Tragen Sie immer eine Schutzbrille, Laborhandschuhe und einen Laborkittel.</p> <p>Die verantwortliche Person (z. B. der Laborleiter) muss alle erforderlichen Vorsichtsmaßnahmen treffen, um sicherzustellen, dass die unmittelbare Umgebung des Arbeitsplatzes sicher ist. Außerdem dürfen beim Bedienen des PowerLyzer 24 Homogenisators die Grenzwerte in Bezug auf Infektionserreger, die in den entsprechenden Sicherheitsdatenblättern (SDS) oder den Vorschriften der OSHA*, ACGIH† oder COSHH‡ festgelegt sind, nicht überschritten werden.</p> <p>Beim Betrieb eines Abzugs und bei der Entsorgung von Abfallstoffen müssen alle Bestimmungen und Gesetze auf Bundes-, Landes- und kommunaler Ebene zu Gesundheitsschutz und Sicherheit am Arbeitsplatz eingehalten werden.</p>

FR	<p>Produits chimiques dangereux</p> <p>Certains produits chimiques utilisés avec l'homogénéisateur PowerLyzer 24 peuvent être dangereux ou le devenir après l'exécution du processus de broyage d'échantillon.</p> <p>Toujours porter des lunettes de sécurité, des gants et une blouse de laboratoire.</p> <p>La personne responsable (par exemple, le directeur du laboratoire) doit prendre les précautions nécessaires afin de garantir que le lieu de travail environnant est sûr et que les opérateurs de l'homogénéisateur PowerLyzer 24 ne sont pas exposés à des niveaux dangereux de substances (chimiques ou biologiques) toxiques comme cela est défini dans les fiches de données de sécurité (FDS) ou dans les documents de l'OSHA *, de l'ACGIH † ou du COSHH ‡ applicables.</p> <p>L'évacuation des vapeurs et la mise au rebut des déchets doivent s'effectuer conformément à toutes les réglementations et lois nationales, régionales et locales relatives à la santé et à la sécurité.</p>
----	---

*OSHA: Occupational Safety and Health Administration (United States of America).

†ACGIH: American Conference of Government Industrial Hygienists (United States of America).

‡COSHH: Control of Substances Hazardous to Health (United Kingdom).

<p>WARNING</p> 	<p>Toxic fumes [W4]</p> <p>Do not use bleach to clean or disinfect used labware. Bleach in contact with salts from the buffers used can produce toxic fumes.</p>
DE	<p>Giftige Dämpfe</p> <p>Verwenden Sie zum Reinigen bzw. Desinfizieren gebrauchter Labormaterialien keine Bleichmittel. Bleichmittel können mit Salzen, die in den Puffern enthalten sind, reagieren und giftige Dämpfe erzeugen.</p>
FR	<p>Vapeurs toxiques</p> <p>Ne pas utiliser de javellisant pour nettoyer ou désinfecter le matériel de laboratoire. Le contact d'un produit à base d'eau de Javel avec des sels provenant des tampons utilisés peut produire des vapeurs toxiques.</p>

<p>WARNING</p> 	<p>Moving parts [W5]</p> <p>Avoid contact with moving parts during operation of the PowerLyzer 24 Homogenizer.</p>
<p>DE</p>	<p>Bewegliche Teile</p> <p>Beim Bedienen des PowerLyzer 24 Homogenisators müssen Sie den Kontakt mit beweglichen Teilen vermeiden.</p>
<p>FR</p>	<p>Pièces mobiles</p> <p>Éviter le contact avec les pièces mobiles pendant le fonctionnement de l'homogénéisateur PowerLyzer 24.</p>

<p>WARNING</p> 	<p>Risk of personal injury and material damage [W6]</p> <p>Do not connect the unit to the main power supply until installation is complete and the correct voltage is selected. Do not turn the unit upside down. The PowerLyzer 24 Homogenizer must always rest on its four feet to avoid damaging internal components or breaking the housing.</p>
<p>DE</p>	<p>Gefahr von Verletzungen und Beschädigung des Geräts</p> <p>Schließen Sie das Gerät erst nach vollständiger Installation und Wahl der korrekten Spannung an der Netzstromversorgung an. Drehen Sie das Gerät nicht über Kopf. Der PowerLyzer 24 Homogenisator muss immer auf seinen vier Füßen stehen, damit innere Bauteile bzw. das Gehäuse nicht beschädigt werden.</p>
<p>FR</p>	<p>Risque de blessures personnelles et de dommages matériels</p> <p>ne pas brancher l'unité à l'alimentation électrique principale tant que l'installation n'est pas terminée et que la bonne tension n'est pas sélectionnée. Ne pas mettre l'unité à l'envers. L'homogénéisateur PowerLyzer 24 doit toujours rester sur ses quatre pieds pour éviter d'endommager les composants internes ou de casser le carter.</p>

<p>WARNING</p> 	<p>Risk of personal injury and material damage [W7]</p> <p>If the voltage supplied to the equipment is higher than what is indicated on the voltage selection switch, the electronics can be irreversibly damaged and the warranty will be voided.</p>
--	---

DE	<p>Gefahr von Verletzungen und Beschädigung des Geräts</p> <p>Wenn die Spannung der Stromversorgung höher ist als die mit dem Spannungsschalter gewählte Spannung, können elektronische Bauteile irreversibel beschädigt werden und die Garantie erlischt.</p>
FR	<p>Risque de blessures personnelles et de dommages matériels</p> <p>si la tension fournie à l'équipement est supérieure à celle qui est indiquée sur le commutateur de sélection de tension, les pièces électroniques peuvent être endommagées de manière irréversible et la garantie sera annulée.</p>

<p>WARNING</p> 	<p>Electrical hazard [W8]</p> <p>Do not modify the plug or cords that are provided. Damaged or worn power cords should be repaired or replaced immediately by a qualified electrician.</p>
DE	<p>Gefahr durch Stromschlag</p> <p>Mitgelieferte Stecker und Kabel dürfen nicht modifiziert werden. Beschädigte bzw. abgenutzte Stromkabel müssen umgehend von einem qualifizierten Elektriker repariert bzw. ersetzt werden.</p>
FR	<p>Danger électrique</p> <p>ne pas modifier la prise ou les câbles qui sont fournis. Les câbles d'alimentation endommagés ou usés doivent être réparés ou remplacés immédiatement par un électricien qualifié.</p>

<p>WARNING</p> 	<p>Risk of personal injury and material damage [W9]</p> <p>Avoid violent shock that may damage the equipment. The motor in the PowerLyzer 24 Homogenizer must remain firmly contained within the unit during shipments to prevent damage.</p>
DE	<p>Gefahr von Verletzungen und Beschädigung des Geräts</p> <p>Vermeiden Sie starke Stöße, die das Gerät beschädigen könnten. Beim Transport muss der Motor des PowerLyzer 24 Homogenisators sicher verpackt sein, um Schäden zu vermeiden.</p>

FR	<p>Risque de blessures personnelles et de dommages matériels</p> <p>éviter tout choc violent pouvant endommager l'équipement. Le moteur de l'homogénéisateur PowerLyzer 24 doit rester bien en place dans l'unité pendant les transports pour éviter les dommages.</p>
----	---

<p>WARNING</p> 	<p>Hazardous chemicals and infectious agents [W10]</p> <p>It is a violation of law to transport biologically hazardous or radioactive materials without proper packaging, labeling, and appropriate warnings.</p>
DE	<p>Gefahrstoffe und Proben mit Infektionserregern</p> <p>Der Transport von biologischen Gefahrstoffen und radioaktiven Materialien ohne ordnungsgemäße Verpackung, Beschriftung und angemessene Warnhinweise ist nicht gesetzmäßig.</p>
FR	<p>Produits chimiques dangereux et échantillons contenant des agents infectieux</p> <p>il s'agit d'une violation de la loi de transporter des substances biologiquement dangereuses ou radioactives sans l'emballage, l'étiquetage et les avertissements appropriés.</p>

<p>WARNING</p> 	<p>Risk of personal injury and material damage [W11]</p> <p>The carousel can become very hot during operation. Use caution when handling the tube holder.</p>
DE	<p>Gefahr von Verletzungen und Beschädigung des Geräts</p> <p>Im Betrieb kann das Röhrchenkarussell sehr heiß werden. Daher müssen Sie im Umgang mit der Röhrchenhalterung vorsichtig sein.</p>
FR	<p>Risque de blessures personnelles et de dommages matériels</p> <p>le carrousel peut devenir très chaud pendant le fonctionnement. Manipuler le support de tubes avec précaution.</p>

<p>WARNING</p> 	<p>Risk of personal injury and material damage [W12]</p> <p>Wait until the unit stops and displays "REMOVE SAMPLES—PROGRAM DONE" before opening the door.</p>
--	--

DE	<p>Gefahr von Verletzungen und Beschädigung des Geräts</p> <p>Öffnen Sie die Klappe erst dann, wenn das Gerät anhält und die Meldung „REMOVE SAMPLES—PROGRAM DONE“ (Proben entnehmen – Programm beendet) anzeigt.</p>
FR	<p>Risque de blessures personnelles et de dommages matériels</p> <p>patienter jusqu'à ce que l'unité s'arrête et affiche « REMOVE SAMPLES—PROGRAM DONE » (RETIRER LES ÉCHANTILLONS – PROGRAMME EFFECTUÉ) avant d'ouvrir la porte.</p>

<p>WARNING</p> 	<p>Electrical hazard [W13]</p> <p>Potentially dangerous voltage exists inside the instrument. In order to ensure the user's safety, the rubber containment seal should not be damaged, particularly during the cleaning and/or decontamination procedures.</p>
DE	<p>Gefahr durch Stromschlag</p> <p>Im Gerät gibt es möglicherweise gefährliche Spannungen. Um die Sicherheit des Anwenders zu gewährleisten, darf daher der Gummidichtungsring insbesondere bei der Reinigung und/oder Dekontamination nicht beschädigt werden.</p>
FR	<p>Danger électrique</p> <p>une tension potentiellement dangereuse existe à l'intérieur de l'instrument. Afin d'assurer la sécurité de l'utilisateur, le joint de confinement en caoutchouc ne doit pas être endommagé, en particulier pendant les procédures de nettoyage et/ou de décontamination.</p>

<p>WARNING</p> 	<p>Electrical hazard [W14]</p> <p>Turn off the unit and unplug the power cord before replacing a fuse.</p>
DE	<p>Gefahr durch Stromschlag</p> <p>Vor dem Austausch einer Sicherung muss das Gerät ausgeschaltet und das Stromkabel abgezogen werden.</p>
FR	<p>Danger électrique</p> <p>éteindre l'unité et débrancher le câble d'alimentation avant de remplacer un fusible.</p>

<p>WARNING</p> 	<p>Hazardous chemicals [W15]</p> <p>Unplug unit before cleaning. The housing of the unit can be cleaned with a sponge or a damp cloth moistened with water or 70% ethanol. Be sure unit is completely dry before plugging back in to electrical outlet.</p>
<p>DE</p>	<p>Gefahrstoffe</p> <p>Vor der Reinigung muss das Stromkabel abgezogen werden. Das Gerätegehäuse kann mit einem mit Wasser oder 70%igem Ethanol angefeuchteten Schwamm oder Tuch gereinigt werden. Vor dem erneuten Anschluss des Geräts an der Steckdose müssen Sie sicherstellen, dass die Einheit vollständig getrocknet ist.</p>
<p>FR</p>	<p>Produits chimiques dangereux</p> <p>débrancher l'unité avant le nettoyage. Le carter de l'unité peut être nettoyé avec une éponge ou un chiffon humidifié avec de l'eau ou de l'éthanol 70 %. S'assurer que l'unité est complètement sec avant de rebrancher dans la prise électrique.</p>

<p>WARNING</p> 	<p>Hazardous chemicals [W16]</p> <p>Undiluted ethanol or isopropanol may damage the paint finish.</p>
<p>DE</p>	<p>Gefahrstoffe</p> <p>Unverdünntes Ethanol oder Isopropanol kann den Lack beschädigen.</p>
<p>FR</p>	<p>Produits chimiques dangereux</p> <p>l'éthanol ou l'isopropanol non dilué peut endommager la finition de la peinture.</p>

<p>CAUTION</p> 	<p>The term CAUTION is used to inform you about situations that could result in damage to the PowerLyzer 24 Homogenizer or other equipment.</p> <p>Details about these circumstances are given in a box like this one.</p>
---	--

DE	<p>CAUTION (ACHTUNG)</p> <p>ACHTUNG weist auf Situationen und Umstände hin, die zu einer Beschädigung des Gerätes führen können. Um einen Geräteschaden zu vermeiden, muss die genannte Anleitung unbedingt befolgt werden.</p> <p>Nähere Angaben zu der Art der Gefährdung und der Vermeidung solcher Situationen werden in einem Textfeld wie diesem gemacht.</p>
FR	<p>CAUTION (ATTENTION)</p> <p>Le terme CAUTION (Attention) est utilisé pour signaler les situations susceptibles de provoquer des détériorations de l'instrument ou d'autre matériel.</p> <p>Les détails sur ces circonstances figurent dans un encadré semblable à celui-ci.</p>

<p>CAUTION</p> 	<p>Damage to the instrument [C1]</p> <p>Do not lift the instrument by holding the door. It must be lifted by holding the bottom of the unit. Unpack the PowerLyzer 24 Homogenizer with care and inspect it carefully.</p>
DE	<p>Beschädigung des Geräts</p> <p>Halten Sie das Gerät beim Anheben nicht an der Klappe fest. Das Gerät muss von unten angehoben werden. Packen Sie den PowerLyzer 24 Homogenisator vorsichtig aus und inspizieren Sie das Gerät.</p>
FR	<p>Endommagement de l'instrument</p> <p>ne pas soulever l'instrument en tenant la porte. Il doit être soulevé en tenant le bas de l'unité. Déballez l'homogénéisateur PowerLyzer 24 avec précaution et l'inspecter attentivement.</p>

<p>CAUTION</p> 	<p>Damage to the instrument [C2]</p> <p>Before operating the PowerLyzer 24 Homogenizer, ensure that the black motor gasket is aligned properly on the motor housing. This gasket can shift during shipment.</p>
DE	<p>Beschädigung des Geräts</p> <p>Vor dem Betrieb des PowerLyzer 24 Homogenisators muss geprüft werden, dass die schwarze Motordichtung im Motorgehäuse ordnungsgemäß ausgerichtet ist. Diese Dichtung kann beim Transport verrutschen.</p>

FR	<p>Endommagement de l'instrument</p> <p>avant de faire fonctionner l'homogénéisateur PowerLyzer 24, s'assurer que le joint du moteur noir est correctement aligné sur le carter du moteur. Ce joint peut bouger pendant le transport.</p>
----	--

<p>CAUTION</p> 	<p>Damage to the instrument [C3]</p> <p>To prevent tube breakage at high speeds, specialized bead tubes are required with speeds greater than 4200 rpm.</p>
DE	<p>Beschädigung des Geräts</p> <p>Bei einer Drehzahl ab 4200 rpm werden besondere Aufschlussröhrchen benötigt, damit keine Röhrchen brechen.</p>
FR	<p>Endommagement de l'instrument</p> <p>pour empêcher que le tube se casse à des vitesses élevées, des tubes à billes spécialisés sont nécessaires à des vitesses supérieures à 4 200 tr/min.</p>

<p>CAUTION</p> 	<p>Damage to the instrument [C4]</p> <p>This is a Class A apparatus. The equipment may cause radio-electric interference in a residential environment. In this case, it is recommended that the user takes appropriate measures.</p>
DE	<p>Beschädigung des Geräts</p> <p>Es handelt sich um ein Gerät der Klasse A. Das Gerät kann in einer privaten Wohnumgebung elektromagnetische Störungen verursachen. In einem solchen Fall wird empfohlen, dass der Anwender geeignete Maßnahmen ergreift.</p>
FR	<p>Endommagement de l'instrument</p> <p>il s'agit d'un appareil de classe A. L'équipement peut causer une interférence radioélectrique dans un environnement résidentiel. Dans ce cas, il est recommandé que l'utilisateur prenne les mesures appropriées.</p>

Introduction

Before using the PowerLyzer 24 Homogenizer, it is essential you read this user manual carefully and pay particular attention to the safety information. The instructions and safety information in this user manual must be followed to ensure safe operation of the PowerLyzer 24 Homogenizer and to maintain the PowerLyzer 24 Homogenizer in a safe condition.

Intended use of the PowerLyzer 24 Homogenizer

The PowerLyzer 24 Homogenizer is intended for molecular biology applications. This product is neither intended for the diagnosis, prevention, or treatment of a disease, nor has it been validated for such use either alone or in combination with other products. Therefore, the performance characteristics of the product for clinical use (i.e., diagnostic, prognostic, therapeutic or blood banking) are unknown.

Requirements for PowerLyzer 24 Homogenizer users

This table covers the general level of competence and training necessary for transportation, installation, use, maintenance and servicing of the PowerLyzer 24 Homogenizer.

Task	Personnel	Training and experience
Transportation	No special requirements	No special requirements
Installation, routine use and maintenance	Laboratory technicians or equivalent	Appropriately trained and experienced personnel
Servicing	QIAGEN Instrument Service Specialists only	–

General Description

The PowerLyzer 24 Homogenizer has been designed to lyse and homogenize biological samples contained in bead beating tubes at variable speeds. It can simultaneously process up to 24 samples in 2 ml tubes at very high speed.

Features of the PowerLyzer 24 Homogenizer system

- Simultaneous homogenization of 24 x 2 ml tubes
- Flexibility for any type of sample processing; broad speed range, number of cycles, time, dwell/pause
- Unique front-loading tube position for ease of use and optimal bead beating interaction
- Processing of hundreds of samples per day
- Up to 99 custom programmable settings
- Disposable tubes to ensure no threat of cross-contamination or sample degradation

Installation Procedures

Parts

Prior to operation, remove all parts from the shipping container and inspect for damaged or missing parts. If any parts are found to be damaged or missing, please contact QIAGEN Technical Support.

The PowerLyzer 24 Homogenizer consists of the following parts.

Description	Quantity
Motor Drive Unit (115V or 230V)	1
Finger Plate (black plastic)	1
Tube Holder (blue anodized aluminum)	1
Power Cords (US, EU, UK, AUS)	1 Each
Spare Fuse	1
User Manual	1

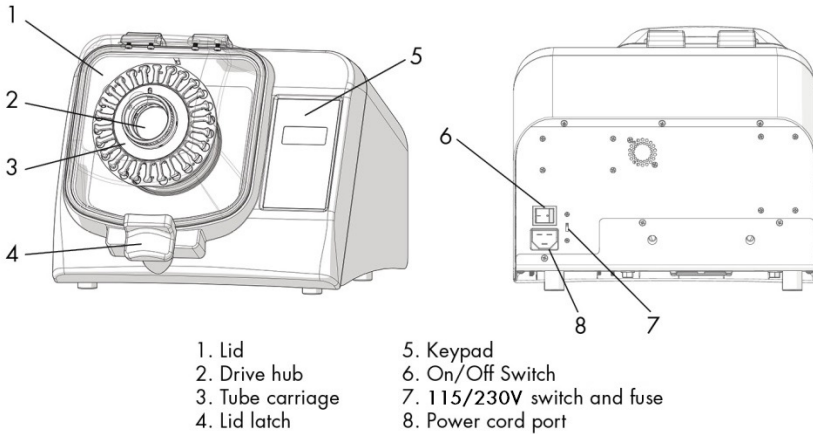

Unpacking the PowerLyzer 24 Homogenizer

<p>WARNING</p> 	<p>Risk of personal injury and material damage [W6]</p> <p>Do not connect the unit to the main power supply until installation is complete and the correct voltage is selected. Do not turn the unit upside down. The PowerLyzer 24 Homogenizer must always rest on its four feet to avoid damaging internal components or breaking the housing.</p>
---	---

Note: Do not discard the crate and packaging foam. This packaging must be used in the event the PowerLyzer 24 Homogenizer needs to be returned to QIAGEN for any reason. Shipping the PowerLyzer 24 Homogenizer in any other packaging will void all warranties.

1. Using a screwdriver or power drill, remove the 16 screws around the bottom edge of the crate.

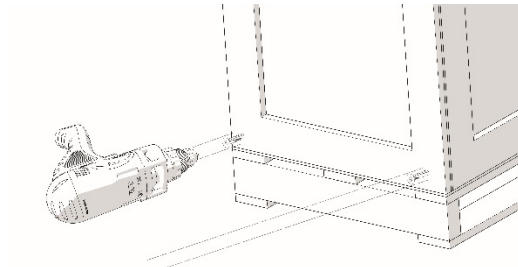

2. Lift the lid from the crate.

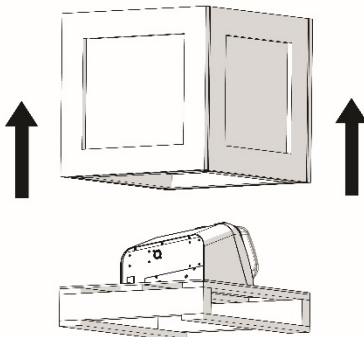

3. Unscrew the two external knob screws from the back of the unit to release from the support plate.

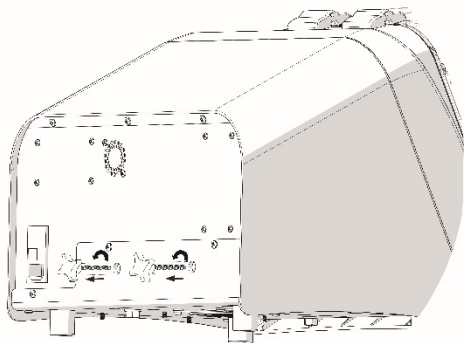

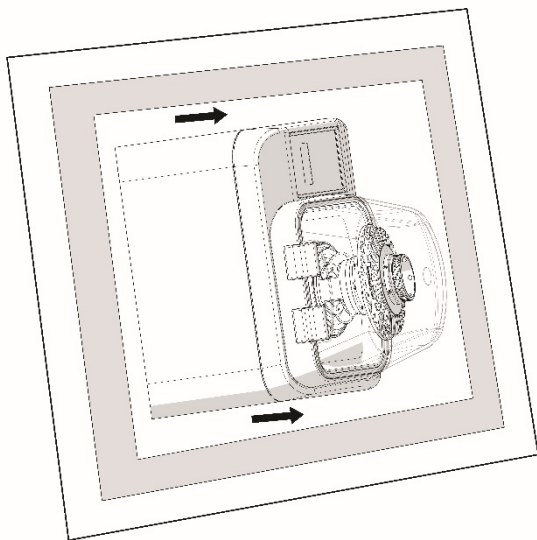

4. Slide the PowerLyzer 24 Homogenizer away from the knob screw holes.

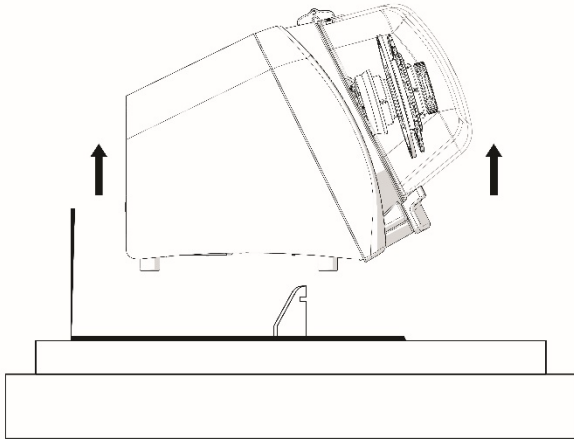

5. Lift the unit up and off of the crate bottom. Do not lift the unit by holding the lid.

Note: This is a heavy item: use caution when lifting to avoid back injury.



<p>CAUTION</p> 	<p>Damage to the instrument [C1]</p> <p>Do not lift the instrument by holding the door. It must be lifted by holding the bottom of the unit. Unpack the PowerLyzer 24 Homogenizer with care and inspect it carefully.</p>
---	---

6. Remove the warning label and make sure the voltage is set correctly for your location before connecting the power cord (see "Installation", below).

Installation

<p>WARNING</p> 	<p>Risk of personal injury and material damage [W6]</p> <p>Do not connect the unit to the main power supply until installation is complete and the correct voltage is selected. Do not turn the unit upside down. The PowerLyzer 24 Homogenizer must always rest on its four feet to avoid damaging internal components or breaking the housing.</p>
---	--

1. Check that the voltage selection switch located at the back of the unit matches the voltage delivered by your electric power supply (15 = 115 V, 30 = 230 V). Use a small screwdriver to slide the red switch up or down to select the correct power supply. Select "15" for 110–120 V or "30" for 225–240 V power supplies. Please note that the slot may not be visible at first when looking at the back of the instrument.

Voltage

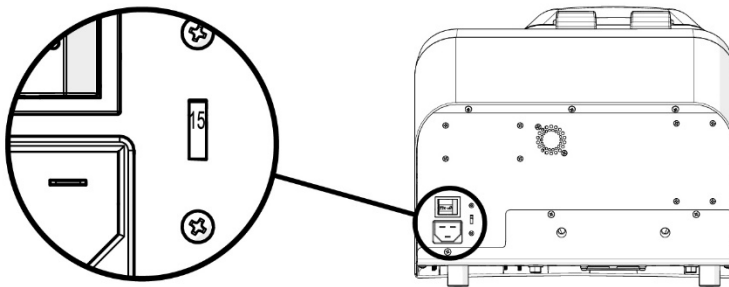

WARNING



Risk of personal injury and material damage

[W7]

If the voltage supplied to the equipment is higher than what is indicated on the voltage selection switch, the electronics can be irreversibly damaged and the warranty will be voided.

2. Ensure that the air vents and the cooling fan are not covered. Allow at least 15 cm (6 in) of space around air vents for proper motor ventilation.
3. Plug the PowerLyzer 24 Homogenizer into the power supply using the appropriate power cord supplied.

In the event of a malfunction or breakdown, grounding provides a path of least resistance for electric current to reduce the risk of electric shock. This instrument is equipped with an electric cord which is grounded to the chassis housing. The plug must be plugged in to an outlet that is properly installed and grounded in accordance with all local codes and ordinances.

WARNING 	Electrical hazard [W8] Do not modify the plug or cords that are provided. Damaged or worn power cords should be repaired or replaced immediately by a qualified electrician.
---	--

Transport

Transporting the PowerLyzer 24 Homogenizer

WARNING 	Risk of personal injury and material damage [W9] Avoid violent shock that may damage the equipment. The motor in the PowerLyzer 24 Homogenizer must remain firmly contained within the unit during shipments to prevent damage.
---	---

Before transporting the equipment:

1. Close the door of the PowerLyzer 24 Homogenizer.
2. Align the slots on the bottom of the unit with the support hooks on the floor of the outer shipping crate.
3. Lower the unit onto the hooks and slide it backward until the back of the unit touches the supporting edge.
4. Secure the unit to the support plate with the included screws.
5. Place the inner crate over the PowerLyzer 24 Homogenizer. Wrap the power cord in bubble wrap and place on top of the unit. Close and seal the inner crate.
6. Place two foam pads at the rear and one foam pad at the front of the PowerLyzer 24 Homogenizer. Place a fourth foam pad on top of the inner crate. Close and seal the outer crate.
7. Place packaged crate on black plastic pallet (provided). Place black plastic corners along edges of crate. Secure crate with tape. Ship crate to QIAGEN along with a completed copy of the Decontamination Certification Form (see Appendix C).

Note: The PowerLyzer 24 Homogenizer must be shipped in an approved packaging crate to avoid damage which may invalidate the warranty. Packaging crates may be purchased for a minimal charge. For additional repair and shipping inquiries, contact QIAGEN Technical Support.

Decontamination

Should an instrument or component that has been used with radioactive or pathogenic material require factory or field service, comply with the following procedure to ensure the safety of service personnel.

Clean the parts to be serviced of all encrusted material and decontaminate them. Radioactivity must not be detectable by survey equipment.

Complete the Decontamination Certification Form (see Appendix C). Please include a copy of the Decontamination Certification Form when shipping the returned item.

If a Decontamination Certification Form is not attached, and a potential radioactive or biological hazard is detected or suspected by QIAGEN, the equipment will not be serviced until proper decontamination and certification is completed. The sender will be contacted for instructions as to the disposition of the equipment. Disposition costs will be charged to the sender.

<p>WARNING</p> 	<p>Hazardous chemicals and infectious agents [W10]</p> <p>It is a violation of law to transport biologically hazardous or radioactive materials without proper packaging, labeling, and appropriate warnings.</p>
---	--

Operating Procedures

This section describes how to operate the PowerLyzer 24 Homogenizer system. Before proceeding, you should familiarize yourself with the features of the PowerLyzer 24 Homogenizer by referring to page 24.

Tube motion

Due to the equipment's design and symmetry, the 24 tubes follow the same motion. This ensures a consistent level of lysis and homogenization for each sample. The mixture contained in the bead beating tubes moves throughout the tubes and moves primarily along the vertical axis to allow for efficient homogenization. Tubes must be evenly balanced on the tube holder.

The following bead beating tubes are recommended for use with the PowerLyzer 24 Homogenizer.

Tube product name	Catalog number
PowerBead Tubes, Ceramic 1.4 mm (50)	13113-50
PowerBead Tubes, Ceramic 2.8 mm (50)	13114-50
PowerBead Tubes, Glass 0.5 mm (50)	13116-50
PowerBead Tubes, Metal 2.38 mm (50)	13117-50
PowerBead Tubes, Glass 0.1 mm (50)	13118-50
PowerBead Pro Tubes, Zirconia	19301

Programming

The PowerLyzer 24 Homogenizer can be programmed for speed, time, number of runs and the length of the dwell or pause between programs. The PowerLyzer 24 Homogenizer memory can store up to 99 custom programs, allowing for maximum repeatability and flexibility.

Programming parameters of the PowerLyzer 24 Homogenizer are shown in the table below.

Parameter	Operating range
Speed	500 to 5000 rpm in increments of 100 rpm
Time	1 s to 9 min: 59 s in increments of 1 s
Number of cycles	1 to 10
Dwell/pause between cycles	Dwell minimum* up to 9 min: 59 s
Storable programs	1 to 99

* Dwell minimum varies depending upon the speed and length of cycle.

Keypad layout

The keypad of the PowerLyzer 24 Homogenizer (see diagram, next page) consists of an LCD screen, four arrow buttons and a "RUN" and "STOP" button.

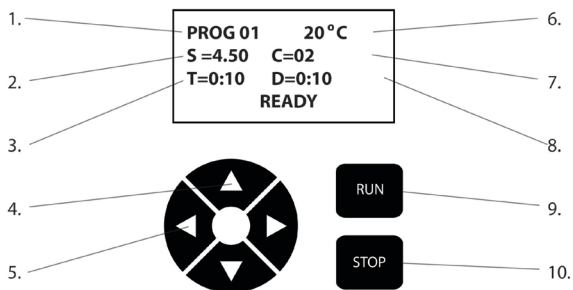

- | | |
|----------------------------------|--|
| 1. Program Number | 6. Processing Chamber Temperature |
| 2. Speed | 7. Number of Cycles |
| 3. Cycle Time | 8. Time interval or Dwell between each cycle |
| 4. Navigation Buttons | 9. Run Button |
| 5. Parameters Adjustment Buttons | 10. Stop Button |

The user can adjust four different homogenization settings with this interface. The ▲ UP and ▼ DOWN arrow buttons are used to navigate through the menu and the ◀ LEFT and ▶ RIGHT arrow buttons are used to adjust parameters.

Startup of the equipment

Turn on the PowerLyzer 24 Homogenizer by pressing the ON/OFF switch located on the rear panel near the AC power input. When the unit is turned on, a welcome screen is displayed for 5 s showing the following information.

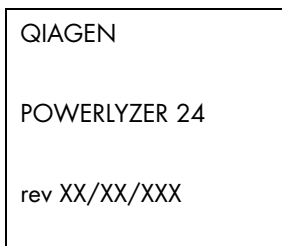

From this screen, the user can select the display language by pressing and holding ► to display the language. The user can then choose from English, Italian, French, German or Spanish by pressing the ▲ and ▼ arrow keys.

After 5 s, a menu displays the programming mode. The programming mode displays the last program run before the power was turned off. An example is shown below.

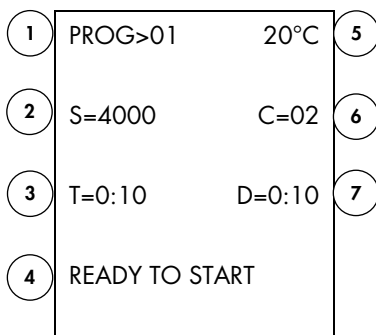

1 Program number

5 Chamber temperature

2 "S=" denotes speed of the motor ranging from 500 to 5000 rpm, in increments of 100 rpm.

6 "C=" denotes the number of times the cycle (speed x time) is repeated. The variable can range from 01 to 10, in increments of 1.

3 "T=" denotes the time interval in min:s. The variable can range from 0:01 to 9:59, in increments of 1 s.

7 "D=" denotes the time interval in seconds of dwell/pause between each cycle. The variable can range from "Dmin" (Dwell minimum* expressed as min:s) to 9:59, in increments of 1 s.

4 System status

* Dwell minimum varies depending upon the speed and length of cycle.

Loading sample tubes

CAUTION**Damage to the instrument****[C2]**

Before operating the PowerLyzer 24 Homogenizer, ensure that the black motor gasket is aligned properly on the motor housing. This gasket can shift during shipment.

Follow the steps listed below to load samples into the PowerLyzer 24 Homogenizer.

1. Place bead tubes symmetrically into the tube holder. If homogenizing fewer than 24 samples, make sure that the tubes are balanced in the tube holder. Use the triangular arrows as a guide to balance the tubes (see right-hand diagram below).

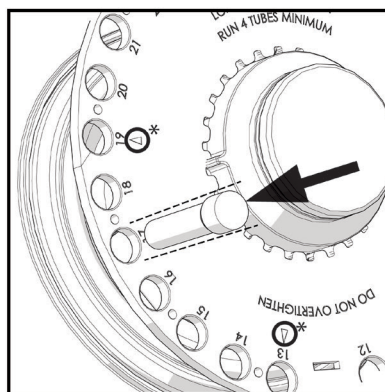
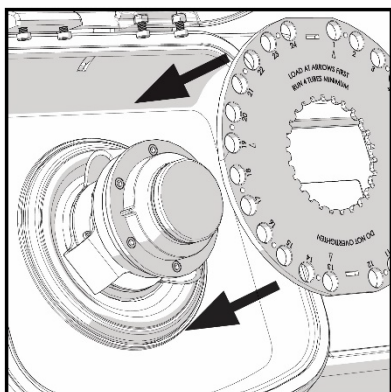

2. Secure the finger plate in place over the carousel and screw about one-eighth of a turn beyond where the fingers contact the top of the tubes. Do not over tighten!

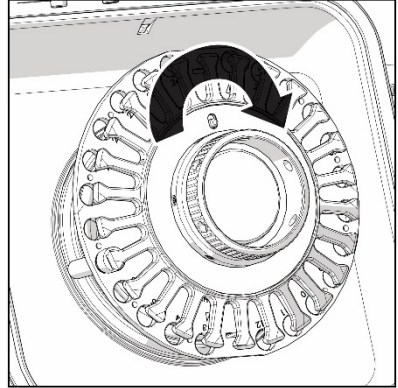
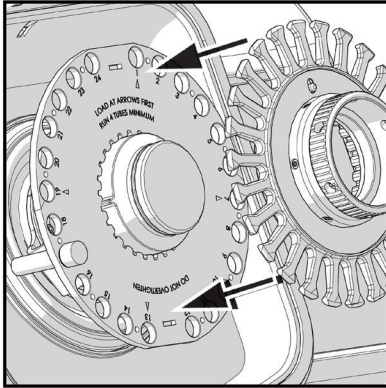

WARNING



Risk of personal injury and material damage

[W11]

The carousel can become very hot during operation. Use caution when handling the tube holder.

3. Move the hub lock switch on the finger plate to the "Lock" position.

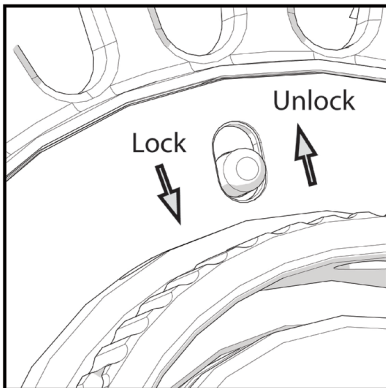

4. Close the door until the locking latch engages and locks.

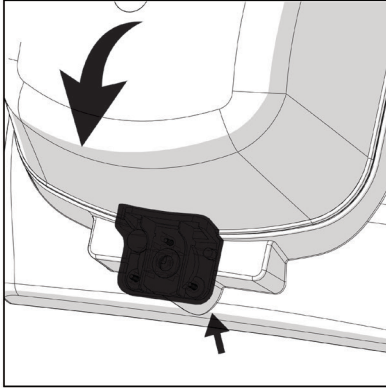

Program settings

After powering up the PowerLyzer 24 Homogenizer, the LCD screen will display the program number blinking in inverse text to denote the “active” variable. The ▲ and ▼ keys move the “active” character (or cursor) between the different variables within the program, and the ◀ and ▶ buttons, respectively, decrease or increase the value of whichever variable is active. Each press of the button will change the variable’s value by one increment. If the ◀ or ▶ buttons are held down, the variable will advance rapidly.

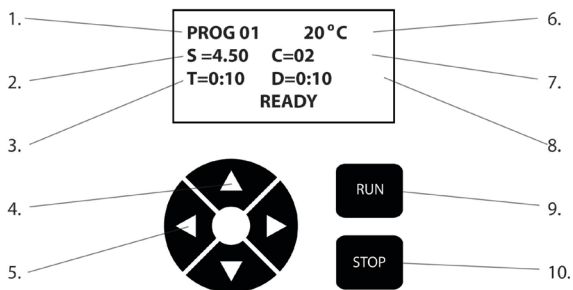

- | | |
|----------------------------------|--|
| 1. Program Number | 6. Processing Chamber Temperature |
| 2. Speed | 7. Number of Cycles |
| 3. Cycle Time | 8. Time interval or Dwell between each cycle |
| 4. Navigation Buttons | 9. Run Button |
| 5. Parameters Adjustment Buttons | 10. Stop Button |

Active variable	System status display
Program: XX	CLOSE DOOR or READY TO START
S	RUN SPEED rpm
T	RUN TIME
C	CYCLES
D	CYCLE DWELL

If the run is stopped or paused, the system status will read "RUN PAUSED."

At the end of the program, "REMOVE SAMPLES" will be displayed followed by "PROGRAM DONE."

WARNING 	Risk of personal injury and material damage [W12] Wait until the unit stops and displays "REMOVE SAMPLES—PROGRAM DONE" before opening the door.
---	---

Please note:

- Homogenization settings cannot be changed once the run is in progress.
- For high-throughput applications, a rest or break period is not required.

The user can pause or stop a run at any time by pressing the “Stop/Pause” button once. The unit displays “RUN PAUSED”. The program can then be continued by pressing “Start/OK” once more. To terminate the program, press the “Stop/Pause” button twice; the unit will then default back to the original program screen display.

Adjusting parameters

Use the ▲ and ▼ arrow keys to move the “active” character (or cursor) between the different variables within the program. The ◀ and ▶ keys, respectively, decrease or increase the value of whichever variable is active.

Adjusting the speed

Use the ▲ and ▼ arrow keys to highlight the “S” speed option.

PROG 04	20°C
S=>4000	C=02
T=0:10	D=0:10
RUN SPEED rpm	

Change the speed value using the ◀ and ▶ arrow keys. The speed adjustment ranges from 500 rpm to 5000 rpm in increments of 100 rpm. When the desired value is reached, the user can proceed to the next desired variable or return to program (“PROG”) to start the run.

CAUTION**Damage to the instrument****[C3]**

To prevent tube breakage at high speeds, specialized bead tubes are required with speeds greater than 4200 rpm.

Adjusting the run time

Use the ▲ and ▼ arrow keys to highlight the “T” time option.

PROG 04	20°C
S=4000	C=02
T=>0:10	D=0:10
RUN TIME	

The user can change the cycle time using the ◀ and ▶ arrow keys. The run time ranges from 1 s to 9 min: 59 s in increments of 1 s. When the desired value is reached, the user can proceed to the next desired variable, or return to program (“PROG”) to start the run.

Adjusting the number of cycles

Use the ▲ and ▼ arrow keys to highlight the “C” cycles option.

PROG 04	20°C
S=4000	C=>02
T=0:10	D=0:10
CYCLES	

The user can change the number of cycles using the ◀ and ▶ arrow keys. The number of cycles ranges from 1 to 10. When the desired value is reached, the user can proceed to the last variable, or return to program ("PROG") to start the run.

Adjusting the pause or "dwell" between cycles

Use the ▲ and ▼ arrow keys to highlight the "D" pause/dwell option.

PROG 04	20°C
S=4000	C=02
T=0:10	D=>0:10
CYCLE DWELL	

The user can change the dwell time between 2 or more cycles using the ◀ and ▶ arrow keys. The dwell time between cycles ranges from 1 s* to 9 min: 59 s in increments of 1 s. Once all variables have been programmed, return the cursor (>) to "PROG" and press "Start/OK". The screen will then display "HUBLOCK ENGAGED?".

PROG 04	20°C
S=4000	C=02
T=0:10	D=>0:10
HUBLOCK ENGAGED?	

* Dwell minimum varies depending upon the speed and length of cycle.

Ensure that the hub lock switch on the finger plate is securely positioned in the “Lock” position. Press “Start/OK” once more to start the programmed run.

Samples can be removed from the PowerLyzer 24 Homogenizer immediately after the run has ended.

<p>WARNING</p> 	<p>Risk of personal injury and material damage [W11]</p> <p>The carousel can become very hot during operation. Use caution when handling the tube holder.</p>
---	--

Recommended settings

Sample name and type	Bead matrix (lysing matrix)	Setting (speed – number of cycles x time – pause)	Application
Microbial			
Bacteria	Zirconia	2000 – 1 x 5 min – 0 s	DNA isolation
Bacteria	Glass 0.1 mm	2000 – 1 x 5 min – 0 s	DNA isolation
Animal			
Muscle	Ceramic 2.8 mm	3500 – 2 x 45 s – 30 s	RNA isolation
Brain	Ceramic 2.8 mm	3500 – 2 x 45 s – 30 s	RNA isolation
Liver	Ceramic 2.8 mm	3500 – 2 x 45 s – 30 s	RNA isolation
Kidney	Ceramic 2.8 mm	3500 – 2 x 45 s – 30 s	RNA isolation
Lung	Ceramic 2.8 mm	3500 – 2 x 45 s – 30 s	RNA isolation
Heart	Ceramic 2.8 mm	3500 – 2 x 45 s – 30 s	RNA isolation
Spleen	Ceramic 2.8 mm	3500 – 2 x 45 s – 30 s	RNA isolation
Plant			
Leaves	Ceramic 2.8 mm	4200 – 2 x 45 s – 30 s	RNA isolation
Leaves	Metal 2.38 mm	2,000 – 1 x 3 min	DNA isolation
Seeds	Metal 2.38 mm	2,900 – 1 x 3 min	DNA isolation
Stems	Ceramic 2.8 mm	4,200 – 2 x 45 s – 30 s	RNA isolation
Stems	Metal 2.38 mm	2,200 – 1 x 3 min	DNA isolation
Roots	Ceramic 2.8 mm	4200 – 2 x 45 s – 30 s	RNA isolation
Root	Metal 2.38 mm	2500 – 1 x 3 min	DNA isolation
Flowers	Ceramic 2.8 mm	4200 – 2 x 45 s – 30 s	RNA isolation
Soil			
Soil	Zirconia	2000 – 1 x 5 min	DNA isolation
Soil	Glass 0.1 mm	Clay: 4000 – 1 x 45 s – 0 s Loose, high humic: 2500 – 1 x 45 s – 0 s	DNA isolation

Homogenizer speed conversion table

Use the chart below to convert FastPrep® or Precellys® homogenizing speed settings to the equivalent PowerLyzer 24 speed setting.

PowerLyzer 24 (rpm)	FastPrep 24 (m/s)	Precellys 24 (rpm)
500–2400	–	–
2500	4	5000
2600	–	5200
2700	–	5400
2800	4.5	5600
2900	–	5800
3000	–	6000
3100	5	6200
3200	–	6400
3300	–	6600
3400	5.5	6800
3500	–	–
3600	–	–
3700	6	–
3800	–	–
3900	–	–
4000	6.5	–
4000–5000	–	–

Note: Equivalent settings slower than 2500 rpm or faster than 4000 rpm on the PowerLyzer 24 Homogenizer cannot be obtained when using the FastPrep or Precellys homogenizers.

Maintenance Procedures

Regular maintenance

This table lists the maintenance actions to be performed by the user on a regular basis to ensure that the PowerLyzer 24 Homogenizer functions properly. Wearing parts are shown in the table below.

Wearing parts	Part number	Frequency of replacement	Reason
Finger plate	13158	1 year or to destruction	Necessary to maintain tubes during homogenization
Fuse	PLFUSE	To destruction	Fuse(s) required to function

WARNING 	Electrical hazard [W13] Potentially dangerous voltage exists inside the instrument. In order to ensure the user's safety, the rubber containment seal should not be damaged, particularly during the cleaning and/or decontamination procedures.
---	---

Replacing the fuse(s)

WARNING 	Electrical hazard [W14] Turn off the unit and unplug the power cord before replacing a fuse.
---	---

There are 2 fuses located directly below the voltage selection switch on the back of the unit. Replace fuse by inserting a flathead screwdriver into the slot on the fuse holder, depressing, and turning 1/4 counter clockwise. Pull out the fuse holder and inspect the fuse. If the core wire is burnt or broken, replace the fuse. Return each fuse holder to its original location.

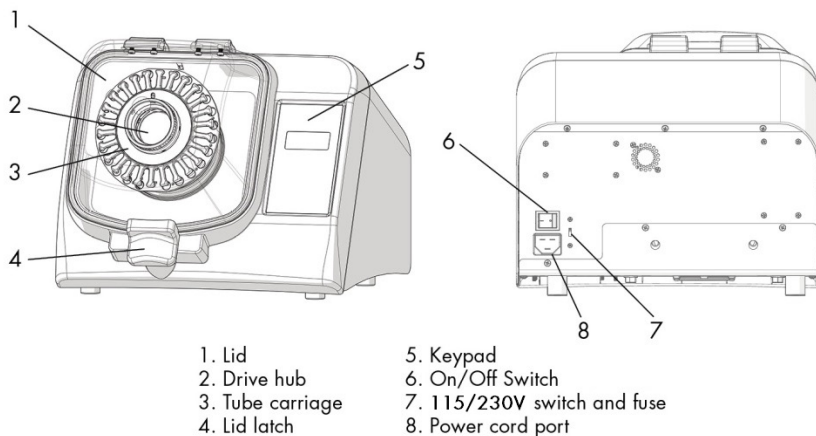

Cleaning and decontamination

WARNING 	Hazardous chemicals [W15] Unplug unit before cleaning. The housing of the unit can be cleaned with a sponge or a damp cloth moistened with water or 70% ethanol. Be sure unit is completely dry before plugging back in to electrical outlet.
---	---

WARNING 	Hazardous chemicals [W16] Undiluted ethanol or isopropanol may damage the paint finish.
---	---

For safety purposes and to prevent any damage to the unit, the recommendations listed below must be followed.

- Do not spray water or alcohol directly on the unit, especially in the air vents and the fan.
- Always disconnect the power cord before cleaning.
- Do not use any type of scrapers.
- Do not use caustic solvents or acetone.

Decontamination procedure

If a tube breaks when a run is in progress, decontaminate parts that may have been contaminated with an appropriate disinfectant. The decontamination procedure is the sole responsibility of the user. Parts that may have been contaminated can be cleaned with a sponge or a damp cloth moistened with 10% bleach solution.

Contact QIAGEN Technical Support if additional or alternative decontamination procedures are required to ensure the compatibility of the new procedure with the instrument.

Troubleshooting Guide

General troubleshooting

Comments and suggestions

Error message: CLOSE DOOR

- | | |
|---|--|
| a) Door not closed and locked properly | Check that nothing prevents the door from closing.
Press the door down and ensure that the handle is locked properly. |
| b) Detection system in the door is faulty | Turn off the unit.
Contact QIAGEN Technical Support. |

Fan does not work

- | | |
|--------------------------|---|
| a) No power | Check main voltage.
Check that the voltage of the unit matches that being delivered by the main power supply.
Make sure that the unit is plugged in properly. |
| b) Faulty fuse | Replace fuse. |
| c) Faulty cooling system | Turn off the unit.
Contact QIAGEN Technical Support. |

No display on the screen

- | | |
|--------------------------|---|
| a) No power | Check main voltage.
Check that the voltage of the unit matches that being delivered by the main power supply.
Make sure that the unit is plugged in properly. |
| b) Faulty fuse | Check and replace fuse(s). |
| c) Faulty display screen | Turn off the unit.
Contact QIAGEN Technical Support. |

One or several tubes not sealed tightly

- | | |
|--|--|
| Cap is not properly sealed or the tube is faulty | If a dangerous or potentially dangerous sample is contained in the tube, apply the proper decontamination procedure. |
|--|--|

Appendix A

Technical data

QIAGEN reserves the right to change specifications at any time.

Environmental conditions

Operating conditions

Power	115 V, 60 Hz or 230 V, 50 Hz
Place of operation	For indoor use only
Temperature	4°C to 40°C (39°F to 104°F)
Humidity	5% to 95% Relative humidity

Storage conditions

Temperature	The unit must be stored in a dry area at a temperature ranging from 0°C to 50°C (32°F to 122°F). Do not freeze.
-------------	---

Mechanical data

Dimensions	Depth: 43.2 cm (17 in)
	Width: 39.4 cm (15.5 in)
	Height: 33 cm (13 in); 61 cm (24 in)with lid open
Mass	24 kg (54 lbs)
Motor speed	500–5000 rpm
Sound level	<70 dB

<p>CAUTION</p> 	<p>Damage to the instrument [C4]</p> <p>This is a Class A apparatus. The equipment may cause radio-electric interference in a residential environment. In this case, it is recommended that the user takes appropriate measures.</p>
---	---

Waste Electrical and Electronic Equipment (WEEE)

This section provides information about disposal of waste electrical and electronic equipment by users.

The crossed-out wheeled bin symbol (see below) indicates that this product must not be disposed of with other waste; it must be taken to an approved treatment facility or to a designated collection point for recycling, according to local laws and regulations.

The separate collection and recycling of waste electronic equipment at the time of disposal helps to conserve natural resources and ensures that the product is recycled in a manner that protects human health and the environment.



Recycling can be provided by QIAGEN upon request at additional cost. In the European Union, in accordance with the specific WEEE recycling requirements and where a replacement product is being supplied by QIAGEN, free recycling of its WEEE-marked electronic equipment is provided.

To recycle electronic equipment, contact your local QIAGEN sales office for the required return form. Once the form is submitted, you will be contacted by QIAGEN either to request follow-up information for scheduling collection of the electronic waste or to provide you with an individual quote.

FCC declaration

The “United States Federal Communications Commission” (USFCC) (in 47 CRF 15. 105) declared that the users of this product must be informed of the following facts and circumstances.

This device complies with part 15 of the FCC. Operation is subject to the following two conditions: (1) This device may not cause harmful interference, and (2) this device must accept any interference received, including interference that may cause undesired operation.

This Class A digital apparatus complies with Canadian ICES-003.

The following statement applies to the products covered in this manual, unless otherwise specified herein. The statement for other products will appear in the accompanying documentation.

NOTE: This equipment has been tested and found to comply with the limits for a Class A digital device, pursuant to part 15 of the FCC Rules. These limits are designed to provide reasonable protection against harmful interference when the equipment is operated in a commercial environment. This equipment generates, uses, and can radiate radio frequency energy and, if not installed and used in accordance with the instruction manual, may cause harmful interference to radio communications. Operation of this equipment in a residential area is likely to cause harmful interference in which case the user will be required to correct the interference at his own expense.



QIAGEN GmbH, Germany is not responsible for any radio television interference caused by unauthorized modifications of this equipment or the substitution or attachment of connection cables and equipment other than those specified by QIAGEN GmbH, Germany. The correction of interference caused by such unauthorized modification, substitution or attachment will be the responsibility of the user.

Declaration of Conformity

Name and address of the company

**QIAGEN GmbH
QIAGEN Strasse 1
40724 Hilden
Germany**

An up-to-date Declaration of Conformity can be requested from QIAGEN Technical Support.

Appendix B

Warranty statement

Thank you for your purchase of QIAGEN instrumentation. Your instrument has been carefully tested to ensure optimum operating efficiency and reproducibility of results. QIAGEN warrants that all new instrumentation manufactured by QIAGEN will correspond to the product specifications and be free from defects in workmanship and materials for a period of twelve (12) months from the original date of shipment.

Repair or replacement of defective parts will be provided to the purchaser during this time period provided the QIAGEN instrumentation is operated under conditions of normal and proper use, but not for damage caused by the customer. If any part or subassembly proves to be defective, it will be repaired or replaced at QIAGEN's sole option, subsequent to inspection at the factory, or in the field by an authorized factory representative, provided that such defect manifested under normal and proper use.

Limitation of warranties and remedies

THE FOREGOING WARRANTY IS QIAGEN'S SOLE AND EXCLUSIVE WARRANTY, AND REPAIR OR REPLACEMENT OF DEFECTIVE PARTS IS THE SOLE AND EXCLUSIVE REMEDY. THERE ARE NO OTHER WARRANTIES OR GUARANTEES, EXPRESS OR IMPLIED. THE IMPLIED WARRANTIES OF MERCHANTABILITY AND FITNESS FOR A PARTICULAR PURPOSE ARE EXPRESSLY EXCLUDED, TO THE FULLEST EXTENT PERMITTED BY LAW. (NOTE: SOME STATES DO NOT PERMIT DISCLAIMERS OF IMPLIED WARRANTIES SO THIS LIMITATION MAY NOT APPLY TO YOU). WITH THE EXCEPTION OF THE ABOVE-REFERENCED REPAIR OR REPLACEMENT REMEDY, QIAGEN SHALL HAVE NO OBLIGATION OR LIABILITY OF ANY NATURE WHATSOEVER WITH RESPECT TO THE QIAGEN INSTRUMENTATION, WHETHER ARISING IN CONTRACT, TORT, STRICT LIABILITY, OR OTHERWISE, INCLUDING BUT NOT LIMITED TO, LIABILITY FOR INDIRECT,

CONSEQUENTIAL, INCIDENTAL AND/OR SPECIAL, PUNITIVE, MULTIPLE AND/OR EXEMPLARY DAMAGES AND/OR OTHER LOSSES (INCLUDING LOSS OF USE, LOST REVENUES, LOST PROFITS AND DAMAGE TO REPUTATION), EVEN IF SUCH DAMAGES WERE FORESEEN OR FORSEEABLE, OR WERE BROUGHT TO QIAGEN'S ATTENTION. IN NO EVENT SHALL QIAGEN'S LIABILITY TO YOU EXCEED THE PURCHASE PRICE OF THE PRODUCT.

Liability clause

QIAGEN shall be released from all obligations under its warranty in the event repairs or modifications are made by persons other than its own personnel, except in cases where the Company has given its written consent to perform such repairs or modifications.

All materials replaced under this warranty will be warranted only for the duration of the original warranty period, and in no case beyond the original expiration date of original warranty unless authorized in writing by an officer of the Company. Read-out devices, interfacing devices and associated software will be warranted only for the period offered by the original manufacturer of these products. Representations and warranties made by any person, including representatives of QIAGEN, which are inconsistent or in conflict with the conditions in this warranty shall not be binding upon the Company unless produced in writing and approved by an officer of QIAGEN.

Appendix C

Decontamination certificate

RA#: _____ Date: _____

Company

Name: _____

Decontamination performed by (please print): _____

Name of unit: PowerLyzer 24 Homogenizer (cat. no. 13155)

Unit Serial/Lot#: _____

Check this box if the instrument/equipment listed above has not been removed from the original packaging AND has not come in contact with any substances or chemicals. If checked, skip to Other Comments section below.

Substances/chemicals used with unit:

Note: Review the “Decontamination” section of the *PowerLyzer 24 Homogenizer User Manual* for important notes regarding the decontamination procedure.

Decontamination procedure used (required for equipment/instruments before return):

Other comments (attach additional comments if needed):

Include this form with the returned item.

Signature: _____ Date sent: _____

Print name: _____

I hereby state that the above information is true and the item I am returning has not been tampered with and/or contaminated. If during QIAGEN decontamination testing it is found that the product has been tampered with and/or contaminated, I understand that I will not receive a refund or a credit to my account.

This page intentionally left blank

Trademarks: QIAGEN®, Sample to Insight®, PowerLyzer® (QIAGEN Group); FastPrep® (MP Biomedicals, LLC); Precellys® (Bertin Technologies). Registered names, trademarks, etc. used in this document, even when not specifically marked as such, are not to be considered unprotected by law.

HB-2422-003 1126492 05/2022 © 2022 QIAGEN, all rights reserved.

Ordering www.qiagen.com/shop | Technical Support support.qiagen.com | Website www.qiagen.com