

QIAcuity[®] User Manual

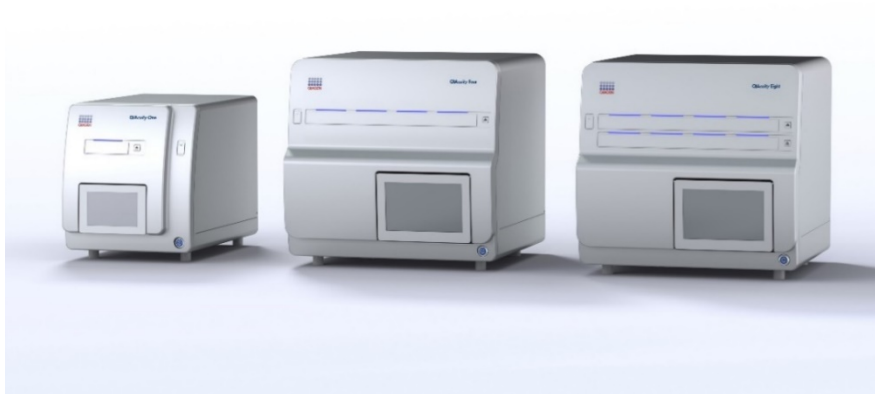

REF

911000, 911020, 911040, 911050



QIAGEN GmbH, QIAGEN Strasse 1, 40724 Hilden, GERMANY

Table of Contents

1. Introduction	9
1.1. About this user manual	9
1.2. General information	10
1.2.1. Technical assistance	10
1.2.2. Policy statement	10
1.3. Intended use of the QIAcuity	10
1.4. Requirements for QIAcuity users	11
2. Safety Information	12
2.1. Proper use	12
2.2. Electrical safety	13
2.3. Environment	14
2.3.1. Operating conditions	14
2.4. Biological safety	15
2.4.1. Samples	15
2.5. Chemicals	15
2.6. Maintenance safety	16
2.7. Radiation safety	16
2.8. Symbols on the QIAcuity	17
3. General Description	18
3.1. QIAcuity principle	18
3.2. External features of QIAcuity	20
3.2.1. Touchscreen	20
Power switch	20
RJ-45 Ethernet port	20
USB ports	21
Power cord socket	21
Cooling air outlet	22
External hand scanner	22
3.3. Thermal cyler	22
3.4. Optical system	23
3.4.1. Available channels	23
4. Installation Procedures	24
4.0.1. Site requirements	24
4.0.2. Power requirements	25
4.0.3. Grounding requirements	25
4.1. Installation of AC power cord	25
4.2. Unpacking the QIAcuity	26
4.3. Packing the QIAcuity	26
4.4. Installing the QIAcuity	27
4.4.1. Removing the protective film from the QIAcuity touchscreen	27
4.4.2. Removing the shipping fixation screw	27
4.4.3. Connecting the power cord to the back of the QIAcuity	28
4.4.4. Powering ON the QIAcuity	28
4.4.5. Removal of protective foam block of the drawer	28
4.4.6. Installing a fresh copy of the QIAcuity Software Suite	29
4.5. Upgrading the QIAcuity Software Suite to a newer version	33
4.5.1. Upgrading QIAcuity Software Suite from version 3.0 or 2.5 (direct upgrade)	34
4.5.2. Upgrading QIAcuity Software Suite from version 2.2 to version 2.5	36
4.5.3. Upgrading QIAcuity Software Suite from version 2.0 to version 2.2	38
4.5.4. Upgrading QIAcuity Software Suite from version 1.2.18 to version 2.0	39

4.5.5. Upgrading QIAcuity Software Suite from version 1.1.3 to version 1.2.18	42
4.5.6. QIAcuity Software Suite Backup	46
Creating backup	46
Restore from backup	47
4.6. Uninstalling the QIAcuity Software Suite	48
4.7. Updating the instrument software	50
4.8. Establishing a connection between the QIAcuity instrument and the QIAcuity Software Suite	52
4.8.1. Private LAN direct connection of one instrument to a co-located Software Suite computer	52
4.8.2. Instrument and Software Suite computer connection via LAN	53
4.8.3. Private LAN with multiple instruments connected to a Software Suite computer	53
4.8.4. Instrument in dedicated subnet with computer also connected to corporate LAN	54
4.8.5. Configuring an ethernet connection between the QIAcuity instrument and the QIAcuity Software Suite	54
4.8.6. Configuring a direct cable connection between the QIAcuity instrument and the QIAcuity Software Suite	58
4.8.7. Configuring the connection to the QIAcuity Software Suite in the QIAcuity instrument software	61
4.9. Getting started with the QIAcuity	64
4.9.1. Configuration of the QIAcuity	64
4.9.2. Procedure	64
4.9.3. Setting basic system data	65
To set the preferred QIAcuity name	65
4.9.4. Managing users	66
4.9.5. Access policy	67
Password expiration	67
Automatic log-off and blocking user account	68
4.9.6. Synchronizing labware with the QIAcuity Software Suite	68
5. Operating Plates	70
5.1. QIAcuity Nanoplate 26K 24-well	70
5.2. QIAcuity Nanoplate 26K 8-well	71
5.3. QIAcuity Nanoplate 8.5K 24-well	71
5.4. QIAcuity Nanoplate 8.5K 96-well	71
5.5. Reaction setup	72
6. Operating the QIAcuity Instrument	74
6.1. Entering text and numbers	75
6.2. Turning on the instrument and logging in	76
6.3. Setting up a run	76
6.4. Setting up an experiment	77
6.4.1. Loading the trays and starting a run	77
6.4.2. Configuring a plate and starting a run	79
6.4.3. Plate configuration procedure	80
6.4.4. Linking a plate to a pre-defined plate without existing barcode	83
6.5. Tracking the run status	84
6.6. Continuous loading and unloading of plates	86
6.7. Aborting a run	87
6.8. Error clearing	88
6.9. Automatic error clearing during the run	90
6.10. Rerunning a plate	90
6.11. Editing the run schedule	91
6.12. Viewing notifications	92
6.13. Disk monitoring	93
6.14. Logging out	94
6.14.1. Automatic logout	95
6.14.2. Accessing the run status when you are logged out	96
7. Operating the QIAcuity Software Suite	97
7.1. Getting started	97

7.1.1. Software workspace	97
Main toolbar	97
Navigation areas	97
Information bar	98
7.2. Concepts of the QIAcuity Software Suite	99
7.2.1. Log-in screen	99
7.2.2. User management	100
7.2.3. Navigating in the User Management panel	101
7.2.4. New user creation	101
7.2.5. Editing an existing user	107
7.2.6. User activation	110
7.2.7. User deactivation	111
7.2.8. Log in (Instrument and PC software)	112
7.2.9. Instrument access (Instrument software)	112
7.2.10. Plates (Instrument and PC software)	112
All plates	112
Owned plates	113
Other permissions	113
7.2.11. Templates (Instrument and PC software)	115
7.2.12. Archive (PC software)	116
7.2.13. User management (PC software)	117
7.2.14. System configuration (PC software)	118
7.2.15. Default Roles	119
7.2.16. New role creation	122
7.2.17. Editing existing role	125
7.2.18. Role deletion	127
7.3. Setting up an experiment	128
7.3.1. Creating a new plate	128
7.4. Plate configurator	130
7.4.1. Defining general data	130
7.4.2. Plate ownership	130
7.4.3. Assigning the owner of the plate	131
7.4.4. Removing an owner of the plate	132
7.4.5. Defining the dPCR parameters	132
Priming tab	133
Cycling tab	133
Gradient cycling	134
Imaging tab	136
High multiplexing	137
7.4.6. Reaction mixes tab	139
Creating new reaction mix	140
7.4.7. Saving reaction mixes as templates	142
Importing reaction mixes from templates	143
7.4.8. Defining samples, controls, and non-template controls	144
Samples	144
Controls	146
Non Template Controls	146
7.4.9. Defining plate layouts	147
Plate view	147
7.4.10. Plate layout: CSV import/export	154
CSV structure	155
Import plate layout from CSV	156
When will the CSV import function fail?	157
Possible errors and warnings	158

7.4.11. Managing your plates	160
Sorting	162
Search	163
Filtering	163
Export and import plate data	163
7.5. Setting up templates	165
7.5.1. Creating a new plate template	165
7.5.2. Saving existing plate as a plate template	166
7.5.3. Using a plate template to create a new plate	167
7.5.4. Creating a new reaction mix template	168
7.5.5. Managing your templates	171
Sorting	171
Filtering	171
New template	171
7.6. Analysis	172
7.6.1. Accessing the analysis environment	172
7.6.2. Plates after QIAcuity Software Suite version upgrade	173
7.6.3. Volume Precision Factor (VPF)	175
Identification of VPF status on plates	175
Loading VPF	177
7.6.4. Custom cross talk matrix	178
Preparing custom cross talk matrix (CXTM)	179
Usage of custom cross talk matrix	185
7.6.5. Images	191
Image quality control	192
7.6.6. Invalidation of images	192
7.6.7. Image corrective measures	193
7.6.8. Dust and other particles	194
7.6.9. Low amplification areas	195
7.6.10. Areas of bad filling	196
7.6.11. Amplitude multiplexing	196
7.6.12. Cross talk correction	197
7.6.13. Reference channel discrepancies	197
7.6.14. General analysis options	199
Selecting wells for analysis	199
Hyperwells	200
Using hyperwells in copy number variation and gene expression analysis	202
Multiple imaging steps	204
Diagram options	205
Horizontal and vertical wells results presentation	206
Dilution calculation option	206
Usage of dilution calculation feature in analysis	207
Conversion factor	209
Range sliders	213
7.6.15. Absolute quantification	214
Absolute quantification – copies per microliter	215
Replicates	216
Setting up an absolute quantification analysis	217
List tab for absolute quantification	219
Export to CSV	220
Signalmap tab for absolute quantification	228
Heatmap tab for absolute quantification	230
Histogram tab for absolute quantification	232
1D Scatterplot tab for absolute quantification	233

2D Scatterplot tab for absolute quantification	240
Assigning partitions to a group using free hand (Polygon mode)	243
Concentration diagram tab for absolute quantification	249
7.6.16. Mutation detection	250
Setting up a mutation detection analysis	251
List tab for mutation detection	252
Heatmap tab for mutation detection	253
Point diagram tab for mutation detection	254
Concentration diagram for mutation detection	255
7.6.17. Genome editing	256
Setting up a genome editing analysis	256
List tab for genome editing	257
Heatmap tab for genome editing	258
Point diagram tab for genome editing	259
Concentration diagram tab for genome editing	260
7.6.18. Copy number variation	261
Setting up a copy number variation analysis with reference target	261
Setting up a copy number variation analysis with reference sample	262
List tab for copy number variation	262
Heatmap tab for copy number variation	264
Point diagram tab for copy number variation	265
Concentration diagram tab for copy number variation	266
7.6.19. Gene expression	268
Setting up a gene expression analysis	268
List tab for gene expression	268
Heatmap for gene expression	270
Point diagram for gene expression	271
Concentration diagram for gene expression	272
7.7. Reports	274
7.7.1. Creating a new report for a plate from the analysis environment	274
7.7.2. Managing reports of a plate in the report environment	277
7.7.3. Sign report	278
7.7.4. Run details in report	281
7.8. Archive	283
Configuring network drive as archive	284
7.8.1. Automatic archiving	289
7.8.2. Manual plate archiving	289
7.8.3. Bulk plate archiving	290
7.8.4. Archive and recovering a plate from the archive	291
7.9. Audit trail	292
7.9.1. Audit trail tracker settings	293
7.9.2. Events List	294
Events list table	294
7.9.3. Search	295
Search for instrument ID, affected plate ID, user login, and role name	295
7.9.4. Filters	295
Filter by specific date or specific time frame	295
Filter: Category	296
Filter: Event type	297
Filter: Initiated by	298
7.9.5. Check details	299
Tracked differences in detailed audit trail events	300
7.9.6. AT part of plate	301
7.9.7. Exporting to PDF	303

7.10. General software use	304
7.10.1. Entering data	304
7.10.2. Displaying errors, warnings, and additional information	304
7.10.3. System error	304
7.10.4. Warning message	304
7.10.5. Information message	305
7.11. QIAcuity Lab Automation Service	305
8. Maintenance Procedures	306
8.1. Cleaning agents	306
General cleaning of the QIAcuity	306
8.1.1. Disinfection	306
Removal of RNase contamination	307
Removal of nucleic acid contamination	307
General instructions	307
8.2. Servicing	308
8.3. Regular maintenance procedure of QIAcuity	308
8.4. Periodic maintenance	309
8.4.1. Air filter change	309
8.4.2. Calibration of thermal cycler	310
8.5. Decontaminating the QIAcuity	310
8.6. Regular maintenance procedure for QIAcuity instrument software	310
8.6.1. Deleting temporary data	310
8.7. Regular maintenance procedure for QIAcuity Software Suite	312
9. Troubleshooting	313
9.1. General information	313
9.2. Contacting QIAGEN Technical Services	313
9.3. Performing a self-check on the QIAcuity instrument	313
9.4. Creating a support package with the QIAcuity instrument software	315
9.5. Software support package	318
9.5.1. Problem with starting the Software Suite	318
9.5.2. Problem at logging screen	320
9.5.3. Problem during the Software Suite runtime	321
9.6. Creating a support package with the QIAcuity Software Suite	322
9.7. Troubleshooting the instrument and software	323
9.8. Accessing the system status and clearing errors	326
10. Technical Specifications	328
10.1. Operating conditions	328
10.2. Transport conditions	328
10.3. Storage conditions	328
10.4. Mechanical data and hardware features	329
11. Glossary	330
Appendix A	331
Declaration of conformity	331
Waste Electrical and Electronic Equipment (WEEE)	331
California Proposition 65	332
Liability Clause	332
Declaration list of China RoHS (SJT 11364-2014)	332
Appendix B — QIAcuity Accessories	334
Ordering information	334
Appendix C — Informations de sécurité	336
Utilisation appropriée	336
Sécurité électrique	337

Environnement	338
Conditions de fonctionnement	338
Sécurité biologique	339
11.0.1. Échantillons	339
Produits chimiques	339
Sécurité de maintenance	340
Sécurité contre les rayonnements	340
Symboles sur le QIAcuity	341
Appendix D – Sicherheitshinweise	342
Sachgemäße Handhabung	342
Schutz vor Stromschlag	343
Umgebung	345
Betriebsbedingungen	345
Biologische Sicherheit	346
Proben	346
Chemikalien	346
Wartungssicherheit	347
Strahlensicherheit	347
Symbole auf dem QIAcuity	348
Appendix E – User Management Permissions	349
Document Revision History	352

1. Introduction

Thank you for choosing QIAcuity. We are confident it will become an integral part of your laboratory. Before using QIAcuity, it is essential that you read this user manual carefully and pay attention to the safety information. The instructions and safety information in the user manual must be followed to ensure safe operation of the instrument and to maintain the instrument in a safe condition.

1.1. About this user manual

This user manual provides information about QIAcuity in the following sections:

- Introduction
- Safety Information
- General Description
- Installation Procedures
- Operating Plates
- Operating the QIAcuity Instrument
- Operating the QIAcuity Software Suite
- Maintenance Procedures
- Troubleshooting
- Technical Specifications
- Appendix B – QIAcuity Accessories
- Appendix C – Informations de sécurité
- Appendix D – Sicherheitshinweise
- Appendix E – User Management Permissions
- Document Revision History

1.2. General information

1.2.1. Technical assistance

At QIAGEN®, we pride ourselves on the quality and availability of our technical support. Our Technical Services Departments are staffed by experienced scientists with extensive practical and theoretical expertise in molecular biology and the use of QIAGEN products. If you have any questions or experience any difficulties regarding the QIAcuity or QIAGEN products in general, do not hesitate to contact us.

QIAGEN customers are a major source of information regarding advanced or specialized uses of our products. This information is helpful to other scientists as well as to the researchers at QIAGEN. We therefore encourage you to contact us if you have any suggestions about product performance or new applications and techniques.

For technical assistance and more information, see our Technical Support Center at www.qiagen.com/support/technical-support or call one of the QIAGEN Technical Service Departments or local distributors (see back cover or visit www.qiagen.com).

1.2.2. Policy statement

It is QIAGEN's policy to improve products as new techniques and components become available. QIAGEN reserves the right to change specifications at any time.

To produce useful and appropriate documentation, we appreciate your comments about this user manual. Contact QIAGEN Technical Services.

1.3. Intended use of the QIAcuity

QIAcuity systems are designed to determine absolute amounts of target DNA in a sample by using a digital PCR (dPCR) approach.

Digital PCR uses the procedure of end-point PCR but splits the PCR reaction into many single partitions in which the template is randomly distributed across all available partitions. After PCR, the target molecule is detected by measuring the fluorescence – either of sequence-specific DNA probes or of intercalating dyes – in all valid partitions. As the template is distributed randomly, Poisson statistics can be used to calculate the amount of target DNA per valid partition. The total amount of target DNA in all partitions of a well is then calculated by multiplying the amount of target DNA per partition with the number of valid partitions. Calculation of target concentration is determined by referring back to the volume in all analyzable partitions, that is, partitions that were filled with reaction mix. The total number of filled partitions is identified by a fluorescent dye, present in the reaction mix itself. Absolute quantification by dPCR eliminates the need of standard curves to determine amounts of target DNA in a given sample.

Aside from absolute quantification, the QIAcuity software provides analysis modules for mutation detection, genome editing analysis, copy number variation (CNV), and gene expression analysis.

QIAcuity systems are intended to be used only in combination with QIAGEN kits indicated for use with the QIAcuity systems for the applications described in the kit handbooks, such as QIAcuity Nanoplates and QIAcuity PCR Reagents.

If QIAcuity is used with products other than QIAGEN kits or QIAGEN assays designed for dPCR, it is the user's responsibility to validate the performance of such product combinations for any particular application.

The QIAcuity system is intended for use by professional users trained in molecular biological techniques and the operation of the QIAcuity system.

The QIAcuity system is intended for molecular biology applications. This product is not intended for the diagnosis, prevention, or treatment of a disease.

1.4. Requirements for QIAcuity users

This table covers the general level of competence and training necessary for transportation, installation, use, maintenance, and servicing of the QIAcuity systems.

Table 1. Requirements for QIAcuity users

Task	Personnel	Training and experience
Delivery	No special requirements	No special requirements
Installation	Laboratory technicians or equivalent	Appropriately trained or experienced personnel familiar with the use of computers and automation in general
Routine use (running protocols)	Laboratory technicians or equivalent	Appropriately trained or experienced personnel familiar with the use of computers and automation in general
Assay design and validation	Scientist or equivalent	Appropriately trained or experienced personnel familiar with molecular biological techniques
Dust filter replacement	Laboratory technicians or equivalent	Appropriately trained or experienced personnel familiar with the use of computers and automation in general
Preventive maintenance	QIAGEN service personnel or service technicians of an authorized agent	Trained and authorized by QIAGEN
Servicing	QIAGEN service personnel or service technicians of an authorized agent	Trained and authorized by QIAGEN

2. Safety Information

Before using the QIAcuity, it is essential that you read this user manual carefully and pay attention to the safety information. The instructions and safety information in the user manual must be followed to ensure safe operation of the instrument and to maintain the instrument in a safe condition.

Note: Translations of the Safety Information in French and German are available in in Appendix C – Informations de sécurité and Appendix D – Sicherheitshinweise.

The following types of safety information appear in this manual.

WARNING



The term **WARNING** is used to inform you about situations that could result in personal injury to you or others.

Details about these circumstances are given in a box like this one.

CAUTION



The term **CAUTION** is used to inform you about situations that could result in **damage to an instrument** or other equipment.

Details about these circumstances are given in a box like this one.

The advice given in this manual is intended to supplement, not supersede, the normal safety requirements prevailing in the user's country.

2.1. Proper use

WARNING/ CAUTION



Risk of personal injury and material damage

Improper use of the QIAcuity may cause personal injuries or damage to the instrument. The QIAcuity must only be operated by qualified personnel who have been appropriately trained. Servicing of the QIAcuity must only be performed by a QIAGEN field service specialist.

Perform the maintenance as described in the "Maintenance Procedures" section. QIAGEN charges for repairs that are required due to incorrect maintenance.

WARNING



Risk of personal injury and material damage

The QIAcuity is too heavy to be lifted by one person. To avoid personal injury or damage to the instrument, do not lift the instrument alone. The bottom plane shall be used for lifting. Do not lift at the touchscreen.

WARNING



Risk of personal injury and material damage

Do not attempt to move the QIAcuity during operation.

CAUTION



Damage to the instrument

Avoid spilling water or chemicals onto the QIAcuity. Damage caused by water or chemical spillage will void your warranty.

In case of emergency, power OFF the QIAcuity at the power switch located in the back of the instrument and unplug the power cord from the power outlet.

CAUTION **Damage to the instrument**



Only use QIAcuity-specific consumables with the QIAcuity. Do not use the plates without applied top seals. Damage caused by use of other consumables will void your warranty.

CAUTION **Damage to the instrument**



Do not drop objects into the instrument when the plate tray is ejected.

WARNING **Risk of explosion**



The QIAcuity is intended for use with reagents and substances supplied with QIAGEN kits or others that are outlined in respective Information for Use. Use of other reagents and substances may lead to fire or explosion.

CAUTION **Damage to the instrument**



Do not stack instruments and do not place items on top of the QIAcuity.

CAUTION **Damage to the instrument**



Do not lean against the touchscreen when it is pulled out.

2.2. Electrical safety

Note: Disconnect the line power cord from the power outlet before servicing.

WARNING **Electrical hazard**



Any interruption of the protective conductor (earth/ground lead) inside or outside the instrument or disconnection of the protective conductor terminal is likely to make the instrument dangerous.

Intentional interruption is prohibited.

Lethal voltages inside the instrument

When the instrument is connected to line power, terminals may be live and opening covers or removing parts is likely to expose live parts.

WARNING **Damage to electronics**



Before powering ON the instrument, make sure that the correct supply voltage is used.

Use of incorrect supply voltage may damage the electronics.

To check the recommended supply voltage, refer to the specifications indicated in the type plate of the instrument.

WARNING Risk of electric shock



Do not open any panels on the QIAcuity.

Risk of personal injury and material damage

Only perform maintenance that is specifically described in this user manual. Any other maintenance or repair may only be carried out by an authorized Field Service Specialist.

To ensure satisfactory and safe operation of the QIAcuity, follow these guidelines:

- The line power cord must be connected to a line power outlet that has a protective conductor (earth/ground).
- Do not adjust or replace internal parts of the instrument.
- Do not operate the instrument with any covers or parts removed.
- If liquid has spilled inside the instrument, power OFF the instrument, disconnect it from the power outlet, and contact QIAGEN Technical Services.

If the instrument becomes electrically unsafe, prevent other personnel from operating it, and contact QIAGEN Technical Services.

The instrument may be electrically unsafe when:

- It or the line power cord appears to be damaged.
- It has been stored under unfavorable conditions for a prolonged period.
- It has been subjected to severe transport stresses.
- Liquids come in contact directly with electrical components of the QIAcuity.

2.3. Environment

2.3.1. Operating conditions

WARNING Explosive atmosphere



The QIAcuity is not designed for use in an explosive atmosphere.

CAUTION Damage to the instrument



Direct sunlight may bleach parts of the instrument and cause damage to plastic parts. The QIAcuity must be located out of direct sunlight.

CAUTION Risk of overheating



To ensure proper ventilation, maintain a minimum clearance of 10 cm at the sides and rear of the QIAcuity. Slits and openings that ensure the ventilation of the QIAcuity must not be covered.

2.4. Biological safety

Specimens and reagents containing materials from humans should be treated as potentially infectious. Use safe laboratory procedures as outlined in publications such as Biosafety in Microbiological and Biomedical Laboratories, HHS (www.cdc.gov/labs/BMBL.html).

2.4.1. Samples

Samples may contain infectious agents. You should be aware of the health hazard presented by such agents and should use, store, and dispose of such samples according to the required safety regulations.

WARNING Samples containing infectious agents



Samples used with the QIAcuity may contain infectious agents. Handle such samples with the greatest of care and in accordance with the required safety regulations.

Always wear safety glasses, gloves, and a lab coat.

The responsible body (for example, a laboratory manager) must take the necessary precautions to ensure that the surrounding workplace is safe, and that the instrument operators are suitably trained and not exposed to hazardous levels of infectious agents as defined in the applicable Material Safety Data Sheets (MSDSs) or the OSHA¹, * ACGIH,[†] or COSHH[‡] documents.

Venting for fumes and disposal of waste must be in accordance with all national, state, and local health and safety regulations and laws.

* OSHA — Occupational Safety and Health Organization (United States of America)

† ACGIH — American Conference of Government Industrial Hygienists (United States of America)

‡ COSHH — Control of Substances Hazardous to Health (United Kingdom)

2.5. Chemicals

WARNING Hazardous chemicals



Some chemicals used with the QIAcuity may be hazardous or may become hazardous after completion of purification.

Always wear safety glasses, gloves, and a lab coat.

The responsible body (for example, a laboratory manager) must take the necessary precautions to ensure that the surrounding workplace is safe, and that the instrument operators are suitably trained and not exposed to hazardous levels of infectious agents as defined in the applicable Material Safety Data Sheets (MSDSs) or the OSHA¹, * ACGIH,[†] or COSHH[‡] documents.

Venting for fumes and disposal of waste must be in accordance with all national, state, and local health and safety regulations and laws.

* OSHA — Occupational Safety and Health Organization (United States of America)

† ACGIH — American Conference of Government Industrial Hygienists (United States of America)

‡ COSHH — Control of Substances Hazardous to Health (United Kingdom)

2.6. Maintenance safety

**WARNING/
CAUTION**

Risk of personal injury and material damage

Only perform maintenance that is specifically described in this user manual.



WARNING

Risk of fire

Do not allow cleaning fluid or decontamination agents to come into contact with the electrical parts of the QIAcuity.



CAUTION

Damage to the instrument

Do not use bleach, solvents, or reagents containing acids, alkalis, or abrasives to clean the QIAcuity.



CAUTION

Damage to the instrument

Do not use spray bottles containing alcohol or disinfectant to clean surfaces of the QIAcuity.



2.7. Radiation safety

WARNING

Risk of personal injury

Hazard Level 2 laser light: Do not stare into the light beam when using handheld barcode scanner.



2.8. Symbols on the QIAcuity

Symbol	Location	Description
	Type plate on the back of the instrument	CE mark for European Conformity
	Type plate on the back of the instrument	UKCA mark for UK Conformity
	Type plate at the back of the instrument	CSA listing mark for Canada and the USA
	Type plate on the back of the instrument	RCM mark for Australia and New Zealand
	Type plate on the back of the instrument	RoHS mark for China (the restriction of the use of certain hazardous substances in electrical and electronic equipment)
	Type plate on the back of the instrument	Waste Electrical and Electronic Equipment (WEEE) mark for Europe
	Type plate on the back of the instrument	Legal manufacturer
	Type plate on the back of the instrument	Consult instructions for use
	Type plate on the back of the instrument	See "Safety Information" section for risks
	Type plate on the back of the instrument	Date of manufacture
	On the drawer	Biological hazard – some samples used with this instrument may contain infectious agents and must be handled with gloves.

3. General Description

After manually loading and sealing the QIAcuity Nanoplate, the QIAcuity performs a fully automated processing of the QIAcuity Nanoplates, including all necessary steps of plate priming, sealing of partitions, thermocycling, and image analysis. Depending on the plate type, up to 8, 24, or 96 samples per plate can be analyzed. For high sensitivity applications, the QIAcuity Nanoplate 26K 8- or 24-well is available. The number of in-parallel processable plates depends on the instrument configuration (One, Four, Eight). The QIAcuity controls all integrated modules, including a robotic gripper for plate handling, a partitioning module, a PCR thermocycler, and a fluorescence imaging module.

Setting up experiments and the analysis of results is done in the stand-alone QIAcuity Software Suite. The Software Suite and instrument software are able to communicate with each other over a direct connection or a network connection. Setting up an experiment is possible with the QIAcuity Software Suite as well as the instrument.

3.1. QIAcuity principle

The QIAcuity is designed as a walk-away instrument that integrates and automates all plate processing steps. Only the plate preparation must be done manually before starting the run. This includes the pipetting of the target reagents and master mix in the input wells of the plate and the closing of the wells with the top-seal. Once this preparation is complete, the plate is placed in a free plate slot of the instrument tray. By reading the barcode of the plate, the instrument links the plate to the experiment previously defined in the software, and after pressing the **Play** button, all further steps are performed fully automated by the instrument.

The following process steps are done sequentially:

Partitioning: In the first module, the microchannels and partitions of the plate are filled with the target reagents and master mix previously pipetted into the wells. This is done by plunging the pins against the elastic top-seal and the input wells, which creates a peristaltic pressure that pumps the input well liquid into the microchannels and partitions. The connecting channels between the partitions are closed simultaneously by a pressure-controlled rolling process (see the following images).

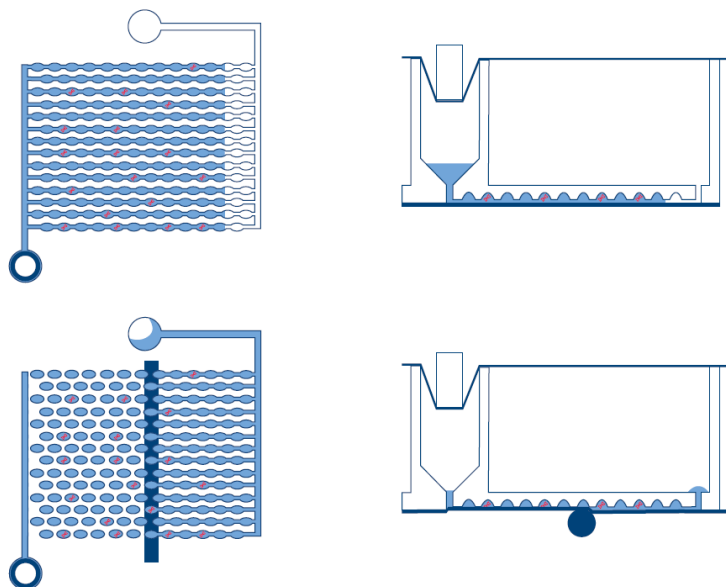

Scheme of filling and partitioning of a well.

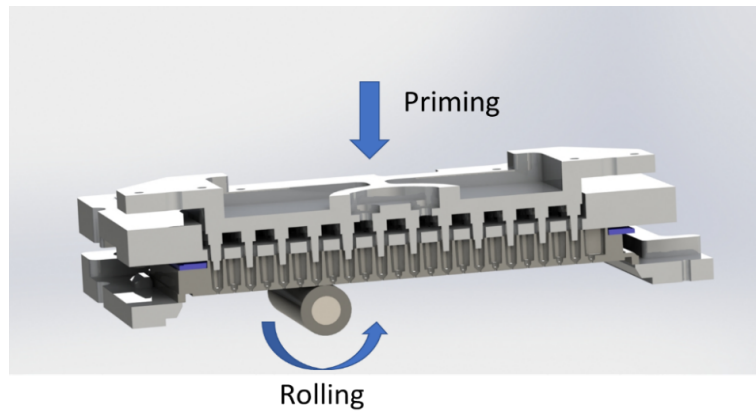

Principle of priming and rolling to allow partitioning of the wells.

Thermocycling: In the second step, the module is a high-accuracy plate thermocycler that performs the polymerase chain reaction. The cycling profile can be set in the QIAcuity Software Suite or the instrument software. For more details on the thermal cycler specification, see the “Technical Specifications” section.

Imaging: The final process step is the image acquisition of all wells. The user can select the detection channels in the experiment setup. The partitions that contain a target molecule inside emit fluorescence and are brighter than the ones without target (see the following images). For more details and specifications on the imaging system, see the “Technical Specifications” section.

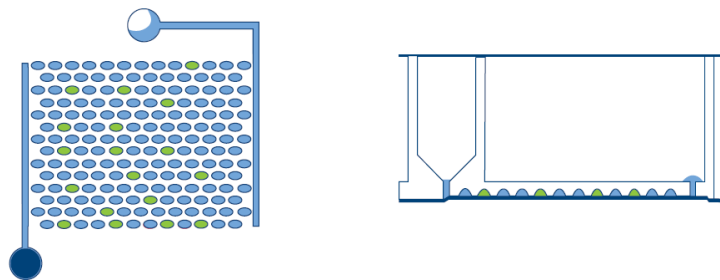

Scheme of positive (green) and negative (blue) partitions after imaging.

3.2. External features of QIAcuity

3.2.1. Touchscreen

The QIAcuity is controlled using a swivel-mounted touchscreen. To adjust the angle of the touchscreen, pull gently at the bottom edge. The touchscreen enables the user to see an overview of all plate slots and the corresponding process steps and remaining times. Additionally, it can be used to extend the plate tray, start/stop plate runs, set up experiments, etc. For all functions and instructions of the instrument software, see “Operating Plates” section.



Pulled out touchscreen.

Power switch

The main power switch is located at the back of the QIAcuity. To power ON the QIAcuity, turn the power switch to **I** and press the blue soft-switch button at the front of the instrument. The startup screen appears, and the instrument automatically performs initialization tests.

To conserve energy, the QIAcuity can be powered OFF when not in use. To power OFF the QIAcuity, press the blue front soft switch.

Important: After powering OFF the QIAcuity, wait for a few seconds before switching ON the instrument again. The system might fail to start if you do not allow the QIAcuity to rest for a few seconds before powering ON.

RJ-45 Ethernet port

The RJ-45 Ethernet port is located at the back of the instrument beside the power cord socket. It is used to connect the QIAcuity to a local area network via cable or to connect directly to the Software Suite computer, depending on the network configuration chosen.

USB ports

The QIAcuity has two USB ports that are located at the front of the instrument in the upper left corner. For the QIAcuity Four and Eight, a third slot for accessories is available behind the touchscreen in the upper right corner. To access this slot, extend the touchscreen as far as possible.

The USB ports allow a connection of the QIAcuity to a USB stick. Data files, such as support package, can be transferred via the USB port from the QIAcuity to the USB stick. The USB ports can also be used to plug in an external barcode reader or a keyboard.

Important: We recommend using QIAGEN USB sticks only to ensure full compatibility. If QIAGEN USB stick is not available, use a FAT32 or exFAT-formatted USB stick.

Important: Do not remove the USB stick while downloading or transferring data or software to or from the instrument.

Power cord socket

The power cord socket is located at the rear right of the QIAcuity and allows connection of the QIAcuity to a power outlet via the supplied power cord.

WARNING Electrical hazard



Any interruption of the protective conductor (earth/ground lead) inside or outside the instrument or disconnection of the protective conductor terminal is likely to make the instrument dangerous.

Intentional interruption is prohibited.

Lethal voltages inside the instrument

When the instrument is connected to line power, terminals may be live and opening covers or removing parts is likely to expose live parts.

WARNING Damage to electronics



Before powering ON the instrument, make sure that the correct supply voltage is used.

Use of incorrect supply voltage may damage the electronics.

To check the recommended supply voltage, refer to the specifications indicated in the type plate of the instrument.

WARNING Risk of electric shock



Do not open any panels on the QIAcuity.

Risk of personal injury and material damage

Only perform maintenance that is specifically described in this user manual. Any other maintenance or repair may only be carried out by an authorized Field Service Specialist.

Cooling air outlet

Cooling air outlets are located at the rear side of the QIAcuity and allow cooling of the internal components of the QIAcuity.

CAUTION Risk of overheating



To ensure proper ventilation, maintain a minimum clearance of 10 cm at the sides and rear of the QIAcuity. Slits and openings that ensure the ventilation of the QIAcuity must not be covered.

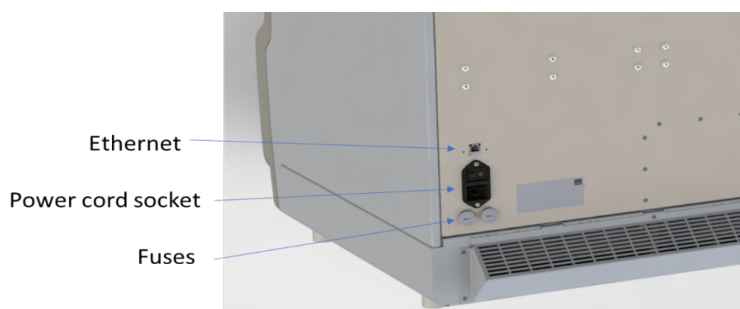

Back view of the QIAcuity Four and Eight.

External hand scanner

The QIAcuity Four and Eight instruments are equipped with a barcode scanner, which enables the user to scan the plate ID before loading. For QIAcuity One, a barcode scanner is available as accessory.

WARNING Risk of personal injury



Hazard Level 2 laser light: Do not stare into the light beam when using handheld barcode scanner.

3.3. Thermal cycler

The thermal cycler of the QIAcuity is a plate thermocycler that features high speed and precision temperature control of the temperature cycling steps. Several Peltier elements are used for the temperature generation and control. For an optimal thermal contact between plate and thermocycler, the plate is clamped on the heating surface during cycling. The QIAcuity Eight features two thermocyclers that are operated in parallel.

The thermal cycler has the following specification:

Process temperature:	35–99°C
Ramp rate:	approx. 3.0°C/s
Accuracy:	±1°C
Homogeneity:	±1°C

3.4. Optical system

The optical system of the QIAcuity is a camera-based fluorescence microscopy system. The excitation source for the fluorescence dyes is a high-power white LED. This source in combination with a specific excitation filter is used to illuminate a whole well at a time. The fluorophores in the single partitions absorb that light and emit light that is being filtered by a detection filter, and collected and imaged through an objective lens on a CMOS-camera chip (see image below for a detailed overview of the components). QIAcuity instruments running under QIAcuity Software version 3.0 support dPCR assays up to 8 plex by using six optical channels for six standard dyes, and the additional use of two hybrid channels for LSS (Long Stokes Shift) dyes, which can be selected from five different hybrid channels. Starting from the QIAcuity Software version 3.1, the amplitude multiplexing option is available, enabling duplex assays using two amplicons in one channel (see the “Amplitude multiplexing” section) supporting dPCR assays up to 12 plex. The QIAcuity One 2 plex offers only two detection channels. In addition to the target detection, channels are also used to detect the base fluorescence of the master mix, to determine the exact number of filled partitions and normalization of fluorescence data.

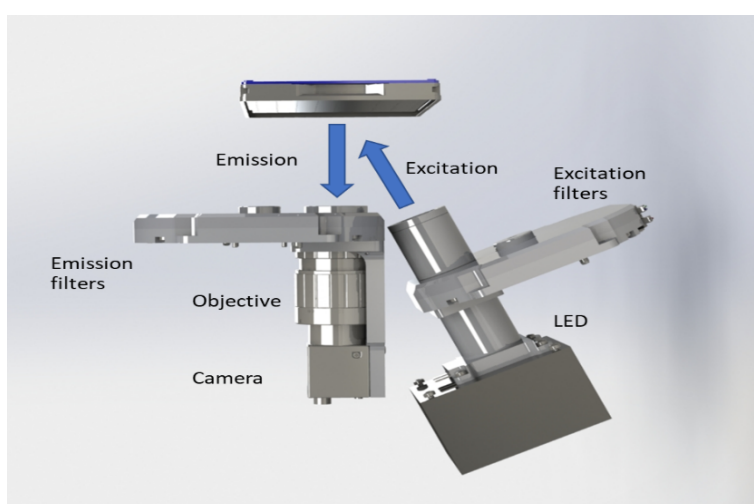

Scheme of the imaging module.

3.4.1. Available channels

Table 2. Available channels in QIAcuity

Channel	Excitation (nm)	Emission (nm)	Example fluorophores
Green	463–503	519–549	FAM™, EvaGreen®
Yellow	513–534	551–565	HEX™, VIC®
Orange	541–563	582–608	TAMRA™, Atto 550
Red	568–594	613–655	ROX™, Texas Red®
Crimson	588–638	656–694	Cy5®, Quasar 680
Far red	651–690	709–759	Cy5.5. Atto 680, Atto 700
Green / Yellow	463–503	551–565	DY-482XL (LSS G/Y)*
Orange / Red	541–563	613–655	DY-540XL (LSS O/R)*

* For Long Stokes Shift (LSS) dyes, the software provides generic dye names called “LSS” followed by the abbreviation of the used channel combination denoted by the first channel letters. For example, channel combination Green/Yellow is abbreviated as “LSS G/Y”.

4. Installation Procedures

This section provides instructions on unpacking, packing, and installing the QIAcuity.

The installation procedure of the product is recommended to be carried out by a certified QIAGEN field service specialist. A person who is familiar with the laboratory and computer equipment should be present during the installation.

4.0.1. Site requirements

The QIAcuity must be located away of direct sunlight, away from heat sources, and away from sources of vibration and excessive electrical interference. Placing another QIAgility[®] instrument or an orbital shaker next to the instrument does not exceed this value. Refer to the “Technical Specifications” section for the operating conditions (temperature and humidity). Be aware that ambient temperatures of below 17°C (63°F) require an equilibration phase of approx. 30–60 min at the location where the instrument will be used before the instrument is powered on. The site of installation should be free of excessive drafts, excessive moisture, and excessive dust, and should not be subject to large temperature fluctuations.

Use a level workbench that is large enough and strong enough to accommodate the QIAcuity. Refer to the “Technical Specifications” section for the weight and dimensions of the QIAcuity. Allow at least 10 cm (5.9 in.) of free space behind and to the sides of the instrument for cooling and cabling.

Ensure that the workbench is dry, clean, and vibration-proof, and has additional space for accessories.

The QIAcuity must be placed within approximately 1.5 m of a properly grounded (earthed) AC power outlet. The power line to the instrument should be voltage-regulated and surge-protected. Ensure that the QIAcuity is positioned where it is easy to access the power connector and the power switch at the back of the instrument at all times, and that it is easy to power the instrument OFF and disconnect it.

Note: We recommend to plug the instrument directly into its own power outlet and not to share the power outlet with other lab equipment. Do not place the QIAcuity on a vibrating surface or near vibrating objects.

WARNING Explosive atmosphere



The QIAcuity is not designed for use in an explosive atmosphere.

CAUTION Risk of overheating



To ensure proper ventilation, maintain a minimum clearance of 10 cm at the sides and rear of the QIAcuity. Slits and openings that ensure the ventilation of the QIAcuity must not be covered.

WARNING Risk of personal injury and material damage



The QIAcuity is too heavy to be lifted by one person. To avoid personal injury or damage to the instrument, do not lift the instrument alone. The bottom plane shall be used for lifting. Do not lift at the touchscreen.

CAUTION Damage to the instrument



Direct sunlight may bleach parts of the instrument and cause damage to plastic parts. The QIAcuity must be located out of direct sunlight.

4.0.2. Power requirements

The QIAcuity operates at 100–240 V AC, 50/60 Hz, 1500 VA (max.)

Ensure that the voltage rating of the QIAcuity is compatible with the AC voltage available at the installation site. Main supply voltage fluctuations should not exceed 10% of nominal supply voltages.

WARNING Damage to electronics



Before powering ON the instrument, make sure that the correct supply voltage is used.

Use of incorrect supply voltage may damage the electronics.

To check the recommended supply voltage, refer to the specifications indicated in the type plate of the instrument.

WARNING Electrical hazard



Any interruption of the protective conductor (earth/ground lead) inside or outside the instrument or disconnection of the protective conductor terminal is likely to make the instrument dangerous.

Intentional interruption is prohibited.

Lethal voltages inside the instrument

When the instrument is connected to line power, terminals may be live and opening covers or removing parts is likely to expose live parts.

4.0.3. Grounding requirements

To protect operating personnel, the National Electrical Manufacturers' Association (NEMA) recommends that the QIAcuity be correctly grounded (earthed). The instrument is equipped with a three-conductor AC power cord that, when connected to an appropriate AC power outlet, grounds (earths) the instrument. To preserve this protection feature, do not operate the instrument from an AC power outlet that has no ground (earth) connection.

WARNING Electrical hazard



Any interruption of the protective conductor (earth/ground lead) inside or outside the instrument or disconnection of the protective conductor terminal is likely to make the instrument dangerous.

Intentional interruption is prohibited.

Lethal voltages inside the instrument

When the instrument is connected to line power, terminals may be live and opening covers or removing parts is likely to expose live parts.

4.1. Installation of AC power cord

The AC power cord connects to the socket located at the rear of the QIAcuity, and the other end to the AC power outlet.

4.2. Unpacking the QIAcuity

WARNING Risk of personal injury and material damage



The QIAcuity is too heavy to be lifted by one person. To avoid personal injury or damage to the instrument, do not lift the instrument alone. The bottom plane shall be used for lifting. Do not lift at the touchscreen.

Note: Before unpacking the QIAcuity, move the package to the site of installation and check that the arrows on the package point upward. In addition, check whether the package is damaged. In case of damage, stop here and contact QIAGEN Technical Services.

1. Cut the straps securing the packaging to the shipping pallet.
2. Open the top of the transportation box to remove the accessories set before lifting the box.
3. Remove the top and side protective black foam.
4. After the QIAcuity has been unpacked, a minimum of two people must lift the instrument. Lift the instrument by sliding your hands under both sides of the workstation and keeping your back straight.
5. **Important:** Do not hold the touchscreen display while unpacking or lifting the QIAcuity as it might damage the instrument.
6. Check if the packing list document is included after unpacking the QIAcuity.
7. Read the packing list to check that you have received all items. If anything is missing, contact QIAGEN Technical Services.
8. Check that the QIAcuity is not damaged and that there are no loose parts. If anything is damaged, contact QIAGEN Technical Services. Make sure that the QIAcuity has equilibrated to ambient temperature before operating it.
9. Retain the package in case you need to transport the QIAcuity in the future. Refer to "Packing the QIAcuity" for more details. Using the original package minimizes the possibility of damage during transportation of the QIAcuity.

4.3. Packing the QIAcuity

WARNING Risk of personal injury and material damage



The QIAcuity is too heavy to be lifted by one person. To avoid personal injury or damage to the instrument, do not lift the instrument alone. The bottom plane shall be used for lifting. Do not lift at the touchscreen.

Note: Before transporting the QIAcuity, the instrument must first be decontaminated. Refer to section "Maintenance Procedures" for more details. Then, prepare the instrument as follows:

1. Turn off the instrument and unplug the power cord.
2. Re-install the shipping fixation screw.
3. Prepare the packing material. Materials required are the cardboard carton, the pallet with foam blocks, and the foam lid.
4. Place the QIAcuity onto the pallet and put the black foam lid over the top of the instrument. Place the box onto the instrument.

Important: When lifting the QIAcuity, slide your hands under both sides of the instrument and keep your back straight.

Important: Do not hold the touchscreen display while lifting the QIAcuity, as this might damage the instrument.

WARNING Risk of personal injury and material damage



The QIAcuity is too heavy to be lifted by one person. To avoid personal injury or damage to the instrument, do not lift the instrument alone. The bottom plane shall be used for lifting. Do not lift at the touchscreen.

Place the accessories into the black foam lid.

Important: The power cord must be packed in an air cushion bags.

5. Seal the outside edges of the carton with tape to protect against moisture.

Note: Using the original package minimizes potential damage during transportation of the QIAcuity.

4.4. Installing the QIAcuity

This section describes important actions that must be performed before operating the QIAcuity. These actions include:

- Removal of the protective film from the QIAcuity touchscreen
- Removal of the shipping fixation screw
- Connection of the power cord to the back of the QIAcuity
- Powering ON the QIAcuity
- Removal of protective foam block of the drawer

4.4.1. Removing the protective film from the QIAcuity touchscreen

Carefully peel off the protective film from the QIAcuity touchscreen.

4.4.2. Removing the shipping fixation screw

Access the back of the instrument and remove the shipping fixation screw using a 4 mm hex wrench. Store the fixation screw in a safe place in case it is needed at a later point in time. The hole in the housing for the fixation screw shall be closed with the dust cap that is provided with the accessories of the instrument (cat. no. 9026772).



Back of QIAcuity.

4.4.3. Connecting the power cord to the back of the QIAcuity

1. Remove the power cord from the foam packing material on top of the QIAcuity.

Note: Only use the power cord that is supplied with the QIAcuity.

2. Check that the voltage rating on the label found at the back of the QIAcuity matches the voltage available at the installation site.
3. Connect the power cord to the power inlet of the instrument and connect the cable to the wall power outlet.
4. Turn on the power switch at the back of the instrument.

WARNING Damage to electronics



Before powering ON the instrument, make sure that the correct supply voltage is used.

Use of incorrect supply voltage may damage the electronics.

To check the recommended supply voltage, refer to the specifications indicated in the type plate of the instrument.

WARNING Electrical hazard



Any interruption of the protective conductor (earth/ground lead) inside or outside the instrument or disconnection of the protective conductor terminal is likely to make the instrument dangerous.

Intentional interruption is prohibited.

Lethal voltages inside the instrument

When the instrument is connected to line power, terminals may be live and opening covers or removing parts is likely to expose live parts.

4.4.4. Powering ON the QIAcuity

Check that the QIAcuity operates properly:

1. Ensure that the drawer of the QIAcuity is closed.
2. Power ON the QIAcuity using the blue front power switch.
3. The startup screen appears. The instrument automatically performs initialization tests.

Note: The main power switch in the back must be switched on for the front power switch to work.

Note: If ambient temperature is below 17°C (63°F), an equilibration phase of 30–60 min might be required. After the equilibration phase, the error can be cleared and the instrument is operational after restart.

4. If there is an initialization error, retry the initialization process by turning the instrument off and on again using the front power switch. If the problem persists, see “Troubleshooting the instrument and software” section or contact QIAGEN Technical Services.

Note: The instrument must be turned off at least once a week using the front power switch.

4.4.5. Removal of protective foam block of the drawer

Open the drawer of the QIAcuity instrument by pressing the physical button on the instrument or tapping Eject Tray on the instrument, and remove the protective foam. For QIAcuity Eight instrument, remove the foam of both drawers.

4.4.6. Installing a fresh copy of the QIAcuity Software Suite

Visit www.qiagen.com and go to the Software section of the QIAcuity product page to check if an updated software version is available for download.

The QIAcuity Software Suite is designed to work with Windows® 10 and Windows 11 operating systems. The following browsers were tested in the QIAcuity Software Suite:

- Mozilla® Firefox®: 132.0.*
- Microsoft Edge®: version 130.0.6723.*
- Google Chrome®: version 130.0.2849.*

Note: Asterisk is used on last position because patch versions of the browsers are released very frequently. They contain mainly bug fixes and should not break browsers' backward compatibility; thus, any of patch versions should be always compatible with QIAcuity Software Suite.

The QIAcuity Four and QIAcuity Eight instruments are supplied with a notebook; the QIAcuity One instrument can be optionally supplied with a notebook. See the following table for the recommended notebook requirements.

Table 3. Recommended notebook requirements

Description	Recommended requirement
Operating system	Microsoft® Windows 10 or Windows 11 Professional Edition 64-bit version
Processor	x64 compatible processor with 4 physical cores and 2.5 GHz
Main memory	16 GB RAM
Hard disk space	At least 500 GB
Graphics interface	At least 1920 x 1080 pixels

Note Windows (10 and 11) security update compatibility and browser updates are being monitored with QIAcuity Software Suite application on a regular basis. So far, an update that lead to failure of our Software Suite Application Service has not been detected; therefore, upgrading the Windows operating system to the latest available build version from Microsoft is recommended. We will continue to monitor security updates and will inform you in case of any issue we might see in the future.

Note: The firewall settings are handled by the Software Suite installer to ensure the proper function of the software. It is recommended to not change any firewall settings after Software Suite installation.

Note: The QIAcuity Software Suite was tested with enabled Microsoft Windows Defender Antivirus.

Note: The QIAcuity Software Suite can also be installed in a virtual machine meeting the hardware requirements of the QIAcuity Software Suite and provided that access to system resources, such as network ports and hard drive, is properly configured. This configuration has been tested with VMware on Windows 2019 server.

The **QIAcuitySoftwareSuite.exe** package needed for the installation of the QIAcuity Software Suite is provided on the USB drive that comes with the QIAcuity. Alternatively, you can download the **QIAcuitySoftwareSuite.exe** package from www.qiagen.com.

Before starting the installation process and after an update of the Windows operating system using the QIAcuity Setup Wizard, note the following important setup information:

1. Ensure that the system data and time of the laptop to be used are up to date.
2. Turn off the standby/hibernation settings in the Windows 10 configuration (for Windows 11, refer to the Microsoft support page – [How to adjust power and sleep settings in Windows - Microsoft Support](#) – to get guidance for your version).
 - a. Right-click **Windows start menu**, and select **Power Options**.
 - b. Click **Change plan settings** next to the current power plan.
 - c. Select **Never** in the “Put the computer to sleep” field.
 - d. Click **Save** changes.
 - e. Click **Change advanced power settings** and expand category **Sleep**.
 - f. Set “Allow Hybrid sleep” fields to **Off** (if this category is visible on your computer).
 - g. Click **Apply**.
 - h. Attach the computer via cable to the local network or connect it to the QIAcuity directly, depending on your preferred setup.

Note: If choosing a direct setup, it is recommended to set the Network adapter settings described in section “Establishing a connection between the QIAcuity instrument and the QIAcuity Software Suite” before continuing with Software Suite installation.

Note: Do not use any USB network adapter in addition to the ethernet cable connected to the instrument or to the laptop.
 - i. It is recommended to switch off the password expiration on the Software Suite laptop.
3. Ensure that the following port is opened (on notebook and network):
 - The inbound TCP port 8080.

Note: It is possible to install the QIAcuity Software Suite as a standalone application without any connection to the instruments (network or direct). After successful installation of the Software Suite, the software application can be used without an ethernet connection.

Note: The installation of the QIAcuity Software Suite shall be performed by a user with full administrator rights in Windows.

Note: Copy the Software Suite installer from the USB stick to the hard drive prior to launching the Software Suite installer. Do not launch installer directly from the USB stick.

To install the QIAcuity Software Suite on the notebook, follow the steps below.

1. Locate the **QIAcuitySoftwareSuite.exe** file on the hard drive and double-click it. The installation process starts.
2. Read the license terms and conditions. These needs to be agreed to by checking the box in the End-User License Agreement window and clicking **Install**.

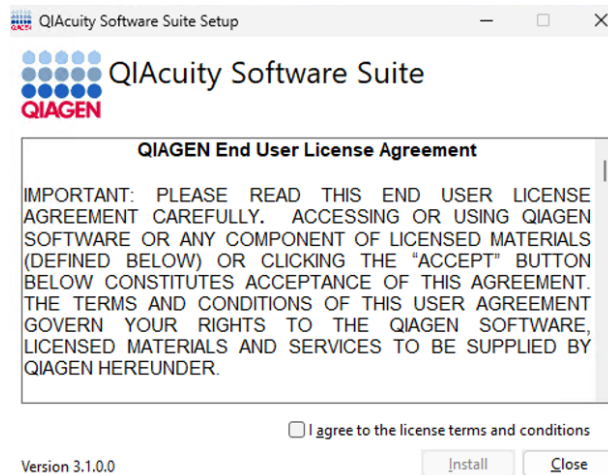

3. In the prompt window asking if changes to the device are allowed, click **Yes**.

Note: During installation, various command line windows may appear in the foreground. Do not close any of them.

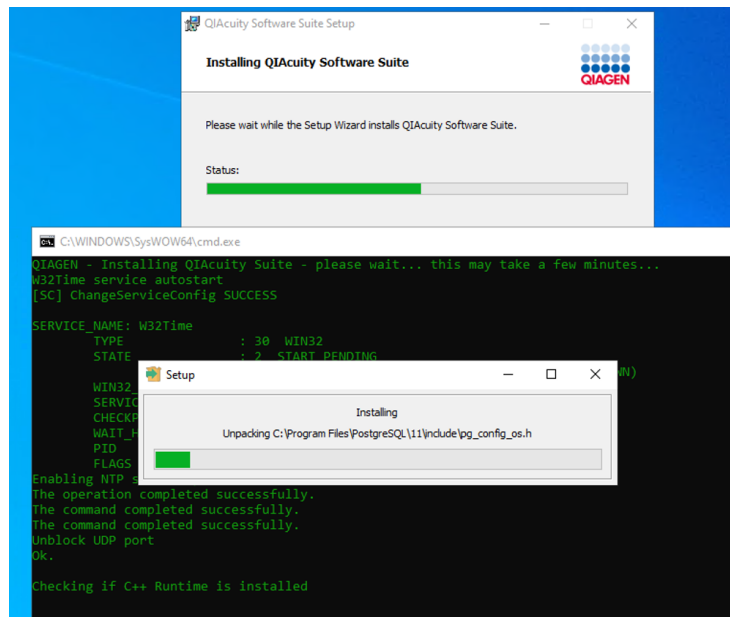

4. When the installation is completed, click **Close**.

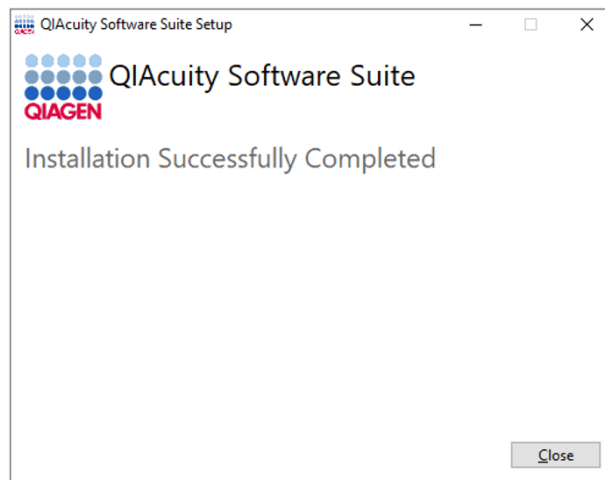

5. In the local host site that says the site is not secure, click **Advanced**.

Note: If the local host is not accessible after the software installation, wait for 2–3 min and open it again.

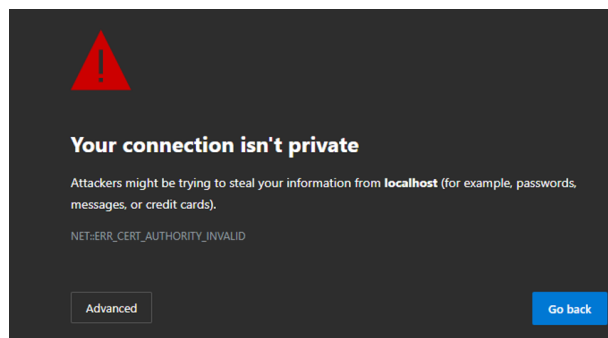

6. Click **Continue** to local host on to the webpage.

You are directed to the QIAcuity Software Suite login screen.

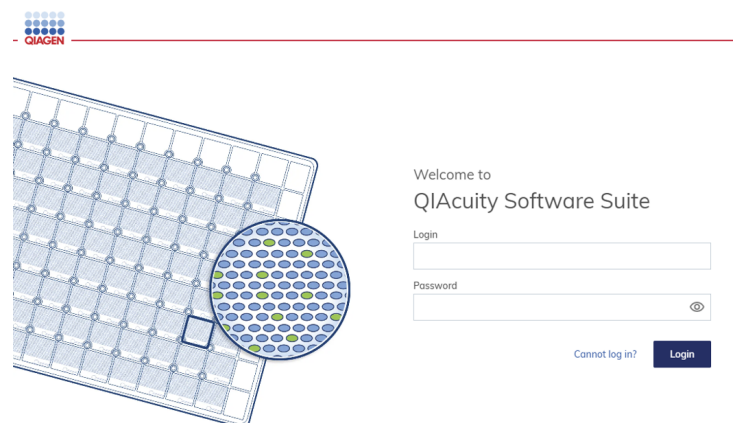

4.5. Upgrading the QIAcuity Software Suite to a newer version

Note the following important information, which is valid for all Software Suite version upgrades:

1. Before upgrading the QIAcuity Software Suite, ensure that no run activity is in progress.
2. The installation of the QIAcuity Software Suite shall be performed by a Windows administrator user.
3. It is strongly recommended to upgrade the Software Suite before proceeding with the control software upgrade.
4. Upgrading to the QIAcuity Software Suite version 3.1 should be performed without uninstallation of the previously installed QIAcuity Software Suite version.
5. Before upgrading the QIAcuity Software Suite, make sure that the system data and time of the laptop to be used are up to date. Be sure to set the Time Zone in Windows first, and then adjust the date and time, if needed. If an adjustment is required, restart the QIAcuity Software Suite application followed by the Control Software before proceeding with the software upgrade.

The latest QIAcuity Software Suite version 3.1 is only compatible with the QIAcuity Control Software version 3.1. If only one software component is upgraded, no connection between the Software Suite and the Control Software can be established.

In terms of existing plates upgrade, refer to "Plates after QIAcuity Software Suite version upgrade" section.

The following two direct upgrade scenarios are supported:

- From version 3.0 to version 3.1
- From version 2.5 (2.5.0.0 and 2.5.0.1) to version 3.1

All Software Suite versions older than version 2.5 (2.5.0.0 and 2.5.0.1) are not supported for a direct upgrade to version 3.1. Refer to the corresponding sections for upgrade instructions:

- Upgrading QIAcuity Software Suite from version 3.0 or 2.5 (direct upgrade)
- Upgrading QIAcuity Software Suite from version 2.2 to version 2.5
- Upgrading QIAcuity Software Suite from version 2.0 to version 2.2
- Upgrading QIAcuity Software Suite from version 1.2.18 to version 2.0
- Upgrading QIAcuity Software Suite from version 1.1.3 to version 1.2.18

Note: In case user is trying to upgrade the software directly to version 3.1 and the upgrade scenario is not supported (e.g., from version 1.2.18), user is informed in the following way:

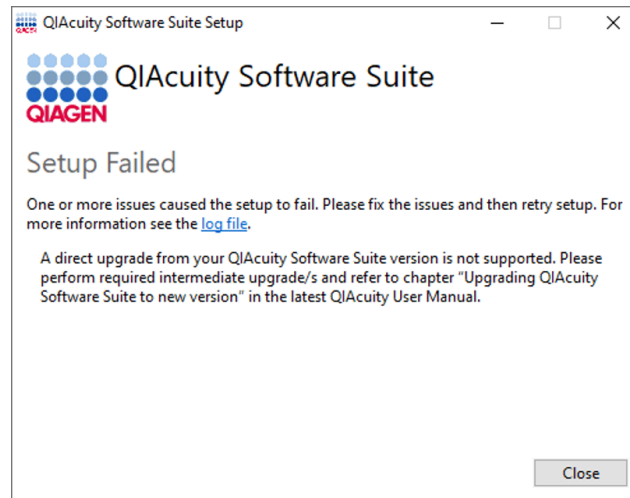

4.5.1. Upgrading QIAcuity Software Suite from version 3.0 or 2.5 (direct upgrade)

To upgrade the QIAcuity Software Suite from version 3.0 or version 2.5 (2.5.0.0 and 2.5.0.1), follow the steps below.

1. Locate the **QIAcuitySuite.exe** file on the hard drive and double-click it. The installation process starts.
2. Check the "I accept the terms in the License Agreement" box in the End-User License Agreement window and click **Install**.

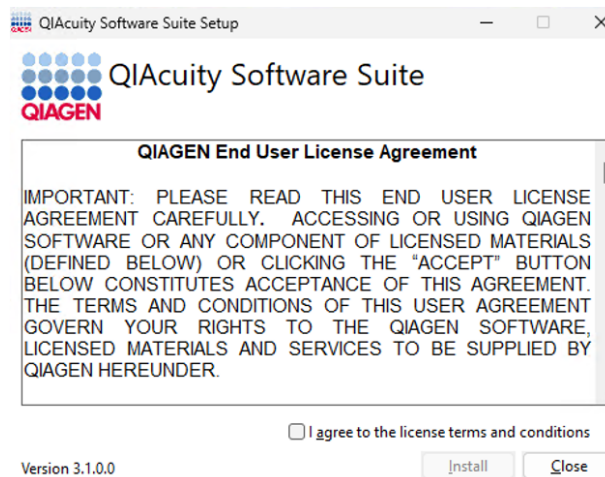

3. In the prompt window asking you if you want to allow changes to your device, click **Yes**.
4. The system will then automatically upgrade the existing installation.

5. When the installation is completed, click **Finish**.

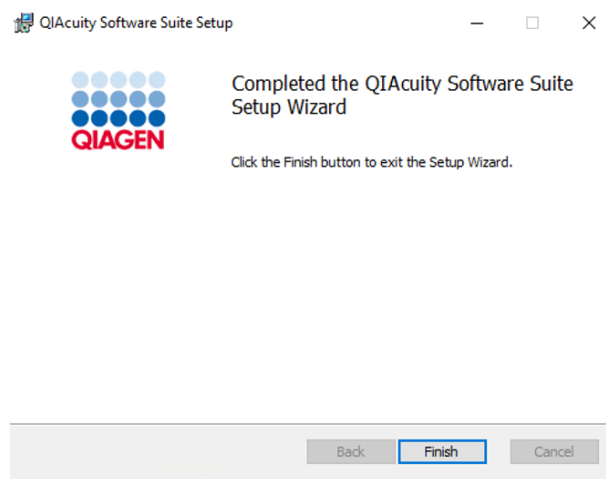

6. Note that the computer must be restarted after a successful QIAcuity Software Suite upgrade. You will receive the following message:

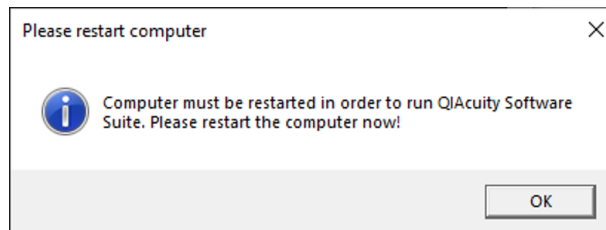

7. Click **OK**.

8. Then click **Restart**, and the computer will begin to restart.

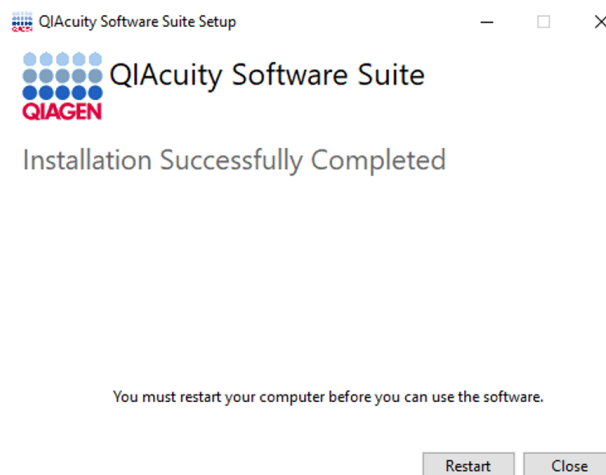

4.5.2. Upgrading QIAcuity Software Suite from version 2.2 to version 2.5

This section describes the QIAcuity Software Suite upgrade from version 2.2. The Software Suite version 2.2 cannot be upgraded directly to version 3.1 but must be upgraded to version 2.5 first.

To upgrade the QIAcuity Software Suite version 2.2 to version 2.5 follow the steps below.

1. Locate the **QIAcuitySuite.exe** file on the hard drive and double-click it. The installation process starts. Click **Next**.
2. Check the "I accept the terms in the License Agreement" box in the End-User License Agreement window, and click **Install**.

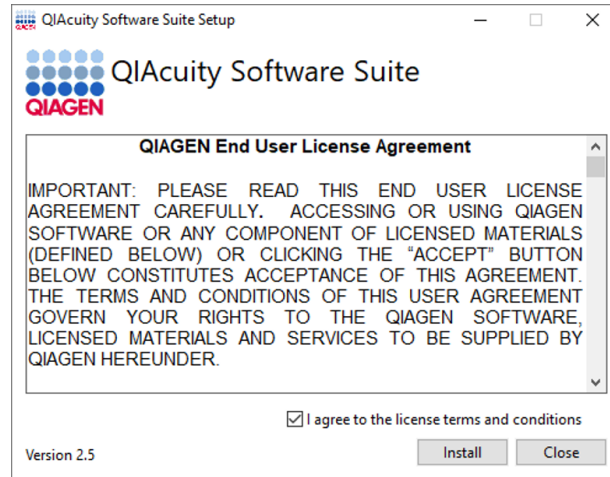

3. In the prompt window asking you if you want to allow changes to your device, click **Yes**.
4. The system will then automatically upgrade the existing installation.
5. When the installation is completed, click **Finish**.

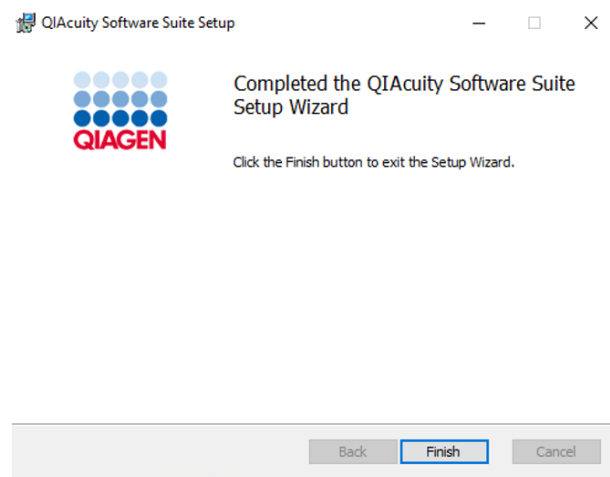

- Note that because the computer must be restarted after successful Software Suite upgrade. The following message will be prompted:

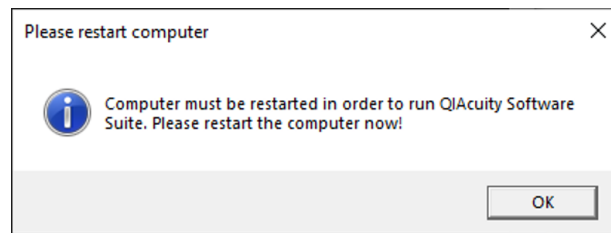

- Click **OK**.
- Then click **Restart**, and the computer will begin to restart.

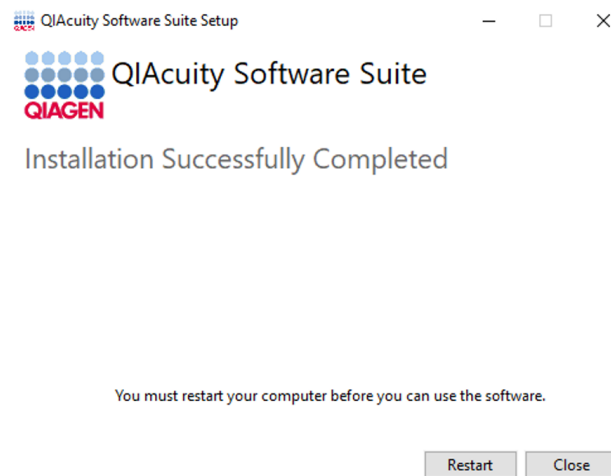

4.5.3. Upgrading QIAcuity Software Suite from version 2.0 to version 2.2

This section describes the QIAcuity Software Suite upgrade from version 2.0. The Software Suite version 2.0 cannot be upgraded directly to version 3.1 but must be upgraded to version 2.2 first.

To upgrade the QIAcuity Software Suite version 2.0 to version 2.2 follow the steps below.

1. Locate the **QIAcuitySuite.exe** file on the hard drive and double-click it. The installation process starts. Click **Next**.
2. Check the "I accept the terms in the License Agreement" box in the End-User License Agreement window, and click **Install**.

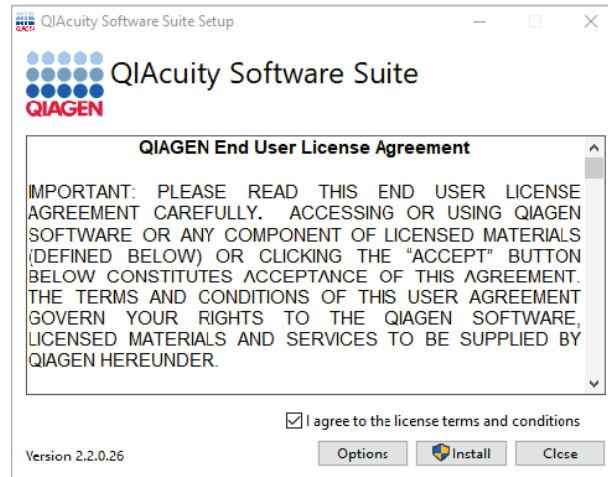

3. In the prompt window asking you if you want to allow changes to your device, click **Yes**.
4. The system will then automatically upgrade the existing installation.
5. When the installation is completed, click **Finish**.
6. Note that because the computer must be restarted after successful Software Suite upgrade, click **Restart**.

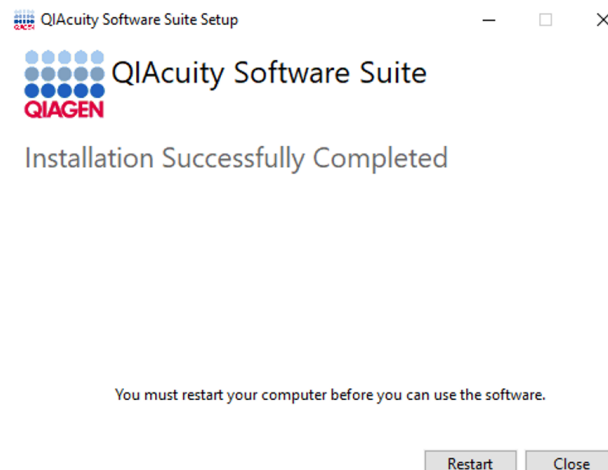

4.5.4. Upgrading QIAcuity Software Suite from version 1.2.18 to version 2.0

This section describes the QIAcuity Software Suite upgrade from version 1.2.18 to 2.5. The Software Suite version 1.2.18 cannot be upgraded directly to version 3.1 but has to be upgraded to version 2.0 first, followed by upgrading to version 2.2.

To upgrade the QIAcuity Software Suite version 1.2.18 to version 2.0 follow the steps below.

1. Locate the **QIAcuitySoftwareSuite.exe** file on the hard drive and double-click it. The installation process starts. Click **Next**.

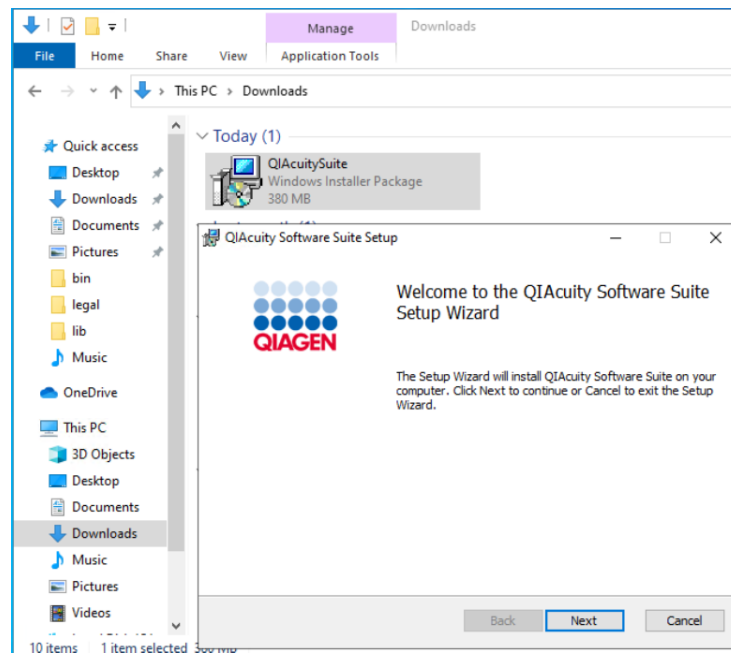

2. Check the "I accept the terms in the License Agreement" box in the End-User License Agreement window, and click **Next**.

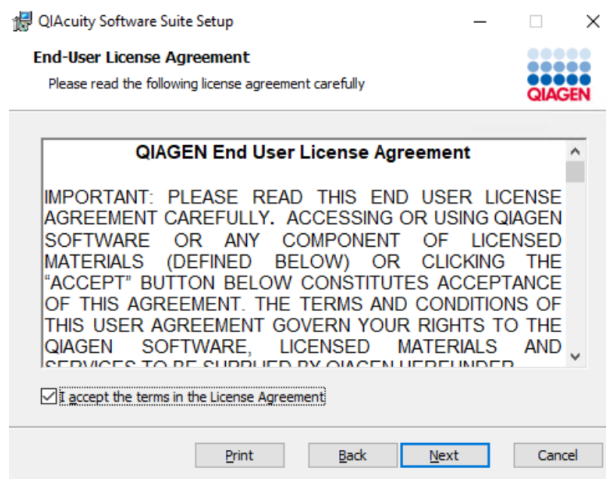

3. Click **Next** in the Destination Folder window.

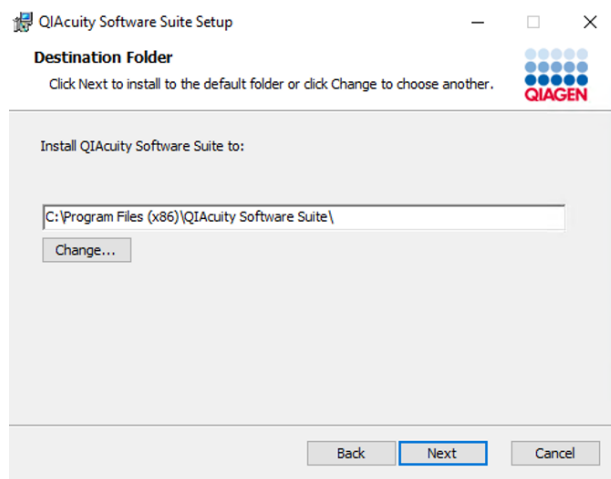

4. Click **Install** to start the installation.

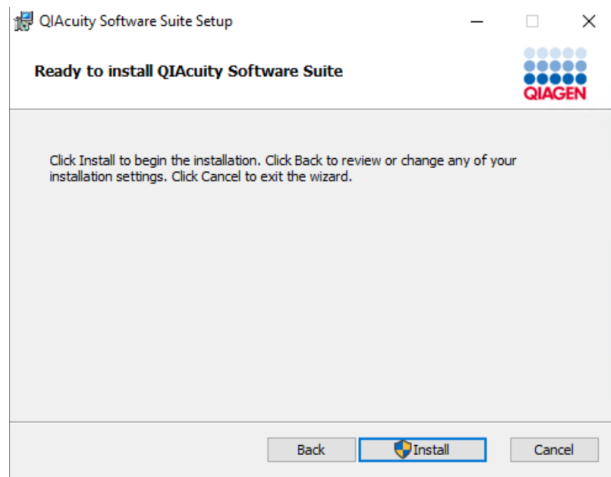

5. In the prompt window asking you if you want to allow changes to your device, click **Yes**.

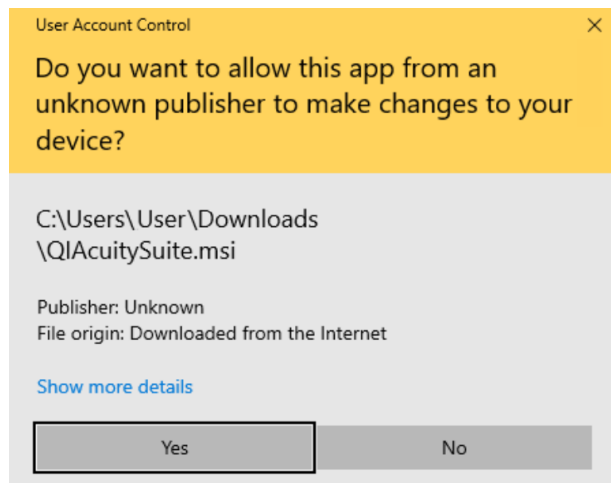

Note: During installation, some command line windows may appear in the foreground. Do not close any of them.

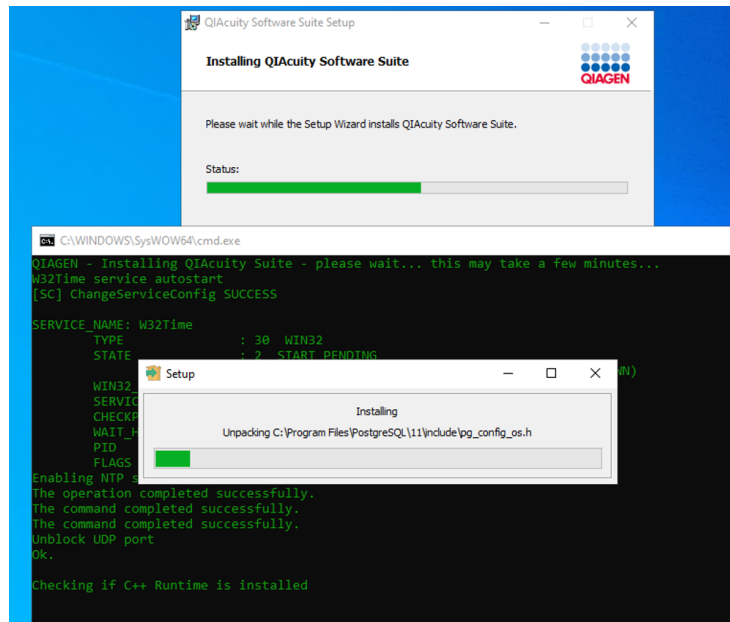

6. When the installation is completed, click **Finish**.

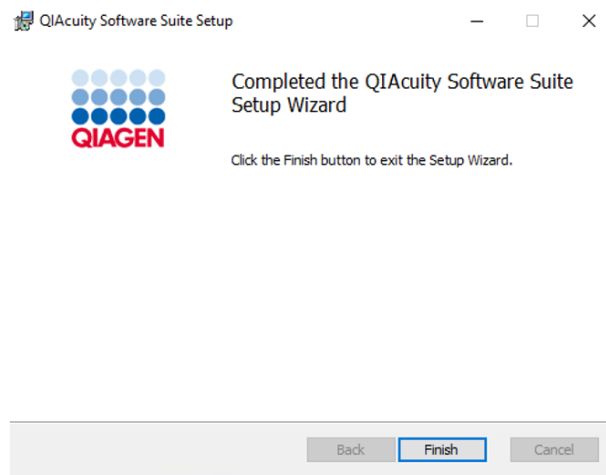

7. Note that the computer must be restarted after a successful QIAcuity Software Suite upgrade. You will receive the following message:

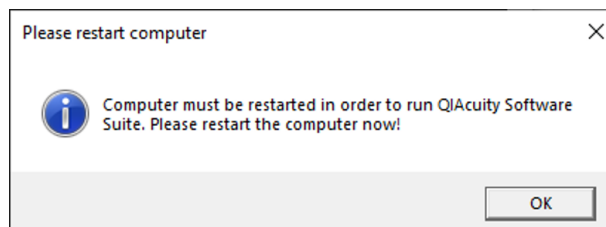

8. Click **OK**.

Then, click **Restart** and the computer will begin to restart.

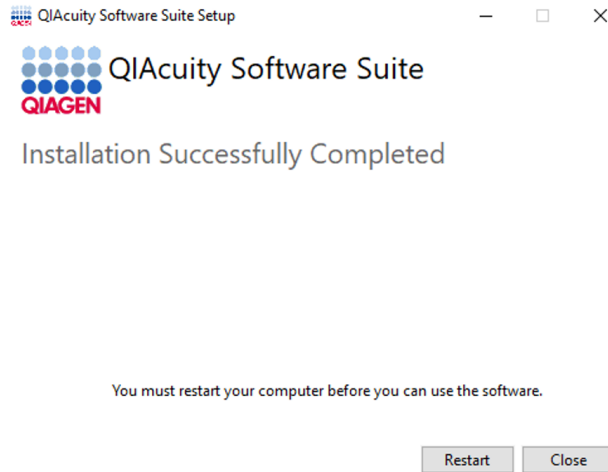

9. Your QIAcuity Software Suite is now upgraded to version 2.0. Next, continue with "Upgrading QIAcuity Software Suite from version 2.0 to version 2.2" section to finally be able to upgrade to 3.0.

4.5.5. Upgrading QIAcuity Software Suite from version 1.1.3 to version 1.2.18

The QIAcuity Software Suite version 1.1.3 cannot be upgraded directly to version 3.1 but has to be upgraded to version 1.2.18 first, then upgraded to version 2.0, and then upgraded to version 2.2 before continuing with the upgrade to the latest version 3.1.

To upgrade the QIAcuity Software Suite version 1.1.3 to the version 1.2.18, follow the steps below:

1. Import all plates from QIAcuity Software Suite 1.1.3, and ensure they are visible in the Plates overview.

Note: Plates from the QIAcuity Software Suite 1.1.3 need to be upgraded together with the Software Suite upgrade. Plates created with the QIAcuity Software Suite 1.1.3 cannot be imported later into the QIAcuity Software Suite 1.2.18 or newer versions at all.

2. Ensure that a direct connection or a connection via network is already established and that the instrument and the PC running the QIAcuity Software Suite 1.1.3 are connected.

3. Locate the **QIAcuitySuite.msi** file on the hard drive and double-click it. The installation process starts. Click **Next**.

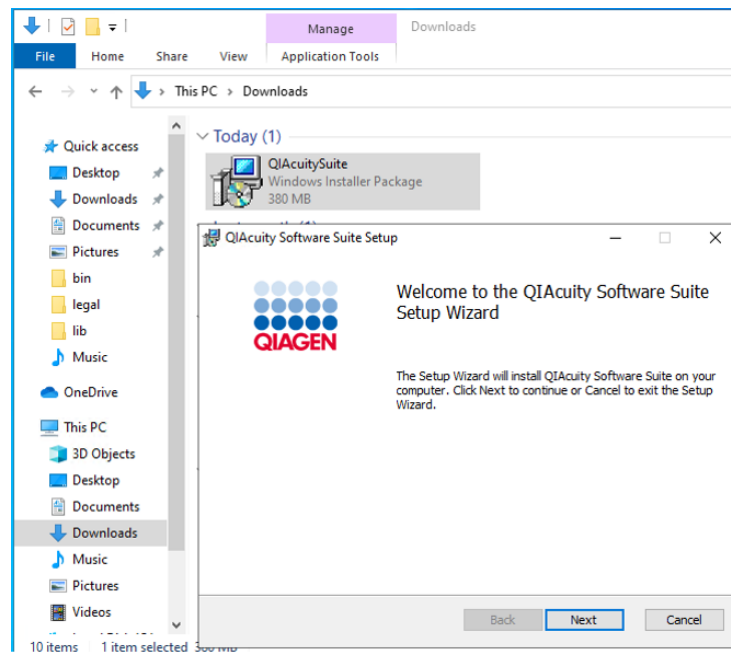

4. Check the "I accept the terms in the License Agreement" box in the End-User License Agreement window and click **Next**.

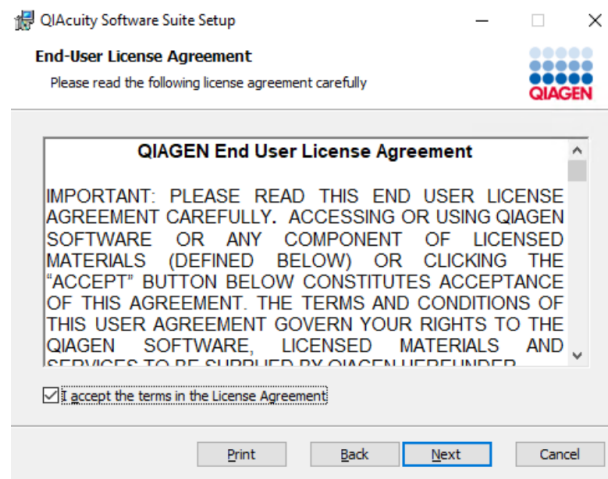

5. Make sure that the Destination Folder points to the existing installation of the QIAcuity Software Suite. Click **Next** in the Destination Folder window.

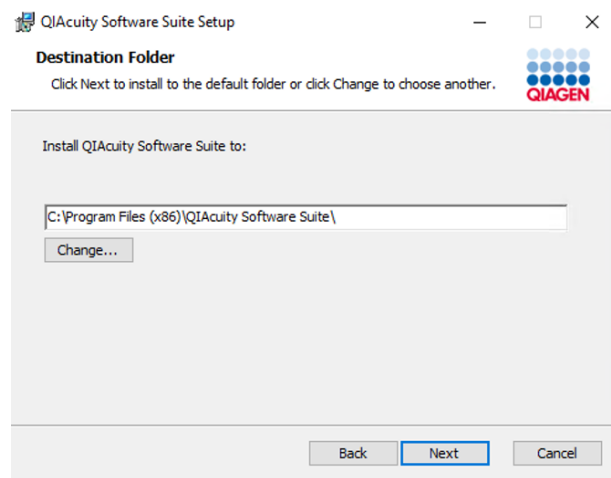

6. Click **Install** to start the installation.

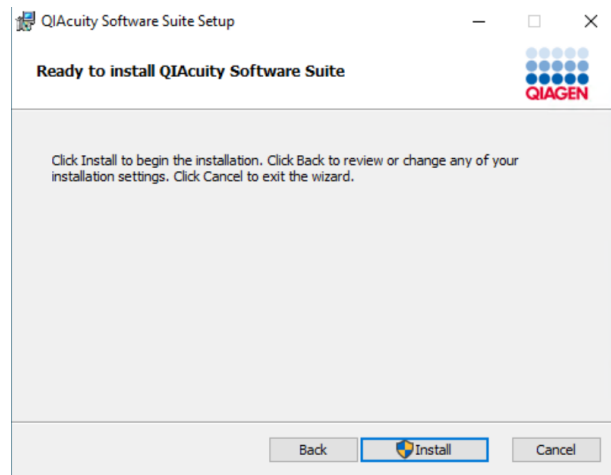

7. In the prompt window asking if you want to allow changes to the device, click **Yes**.

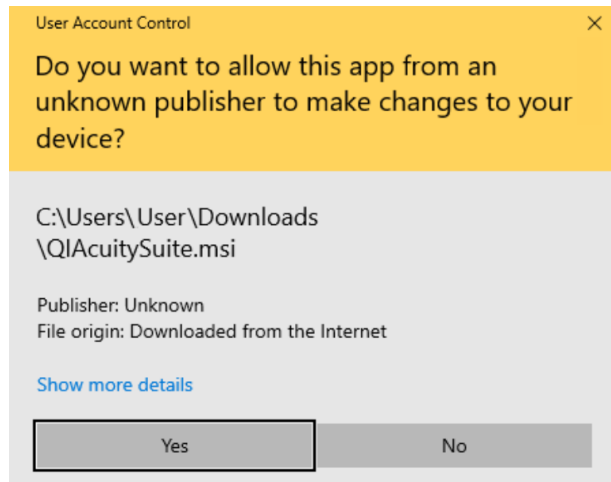

The system will then automatically upgrade the existing installation.

8. When the installation is completed, click **Finish**.

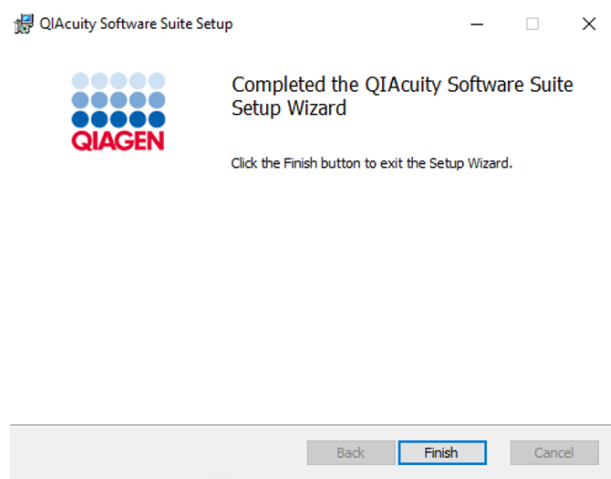

9. Continue with the QIAcuity Software Suite upgrade from version 1.2.18 to version 2.0. Refer to "Upgrading QIAcuity Software Suite from version 2.0 to version 2.2" section.

4.5.6. QIAcuity Software Suite Backup

Note: The integrated backup functionality is only available during upgrading the software; during installation and uninstallation, there is no such option. In case a backup is required after the installation or upgrade of the software, an offline script for QIAcuity Software Suite version 3.1 can be downloaded from www.qiagen.com. This script may be used manually or automatically as part of a regular task. Please see the dedicated *QIAcuity Software Suite Backup and Restore Scripts User Manual* for further information.

Creating backup

The QIAcuity Software Suite version 3.1 automatically creates a data backup during the upgrade process, unless this option was deselected by the user during the upgrade (click **Options**):

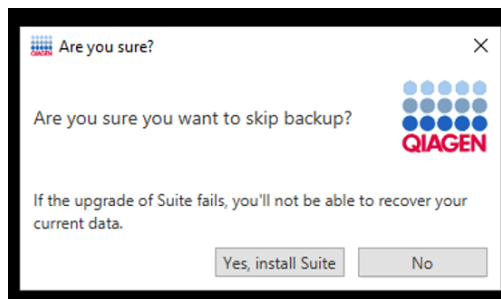

By default, the backup is created on drive **C:\qiacuity_backup_<ddMMyyyyHHmmss>**. The last part of this file name is a timestamp that will allow the user to differentiate backups. Backup location can be specified by the user; the installer will show available disc space for the selected path. The available and required space for backup is displayed. Ensure that required disc space for backup is available.

When there is not enough disc space during upgrade, an unidentified error occurs – refer to “Troubleshooting the instrument and software” section for more details.

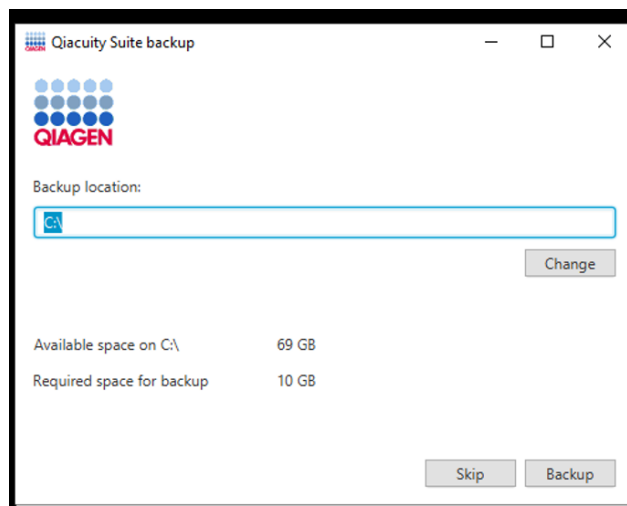

Restore from backup

To restore application from backup:

1. Uninstall the currently installed Software Suite version that is causing the problem (see “Uninstalling the QIAcuity Software Suite” section).
2. Manually remove folders **C:\ProgramData\Qiagen**, **C:\Program Files (x86)\QIAcuity Software Suite**, and **C:\Program Files\Qiagen.CommonInterfaces.QIAidentity** if these folders exist. Be aware that **\ProgramData** might be hidden and you might need to change the view settings of Windows Explorer to view it.
3. Install previously working Software Suite version for which backup was created.
4. Make sure that browser accessing the Software Suite is closed.
5. Navigate to the folder with the backup and run **flash-rollback.exe**, then follow instructions from the pop-up window. It is recommended to run this program as Administrator.

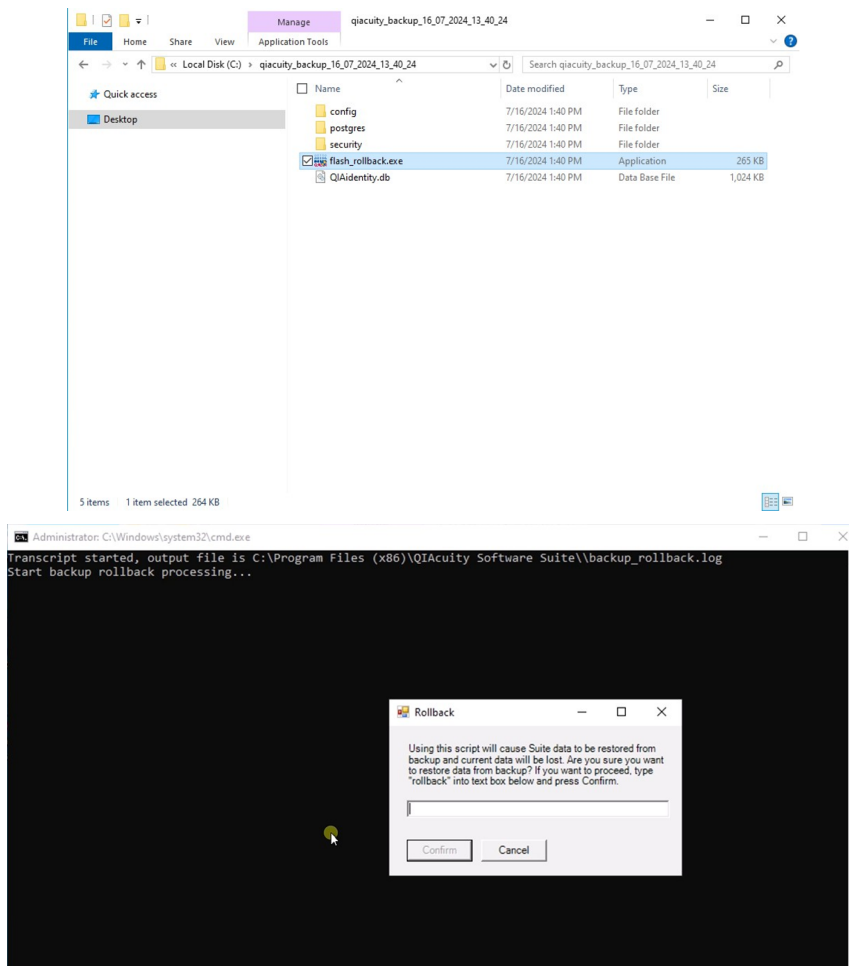

4.6. Uninstalling the QIAcuity Software Suite

To uninstall the QIAcuity Software Suite from your system, follow the steps below. Note that this will lead to loss of all data including plate runs.

1. Go to the **Control Panel** app.

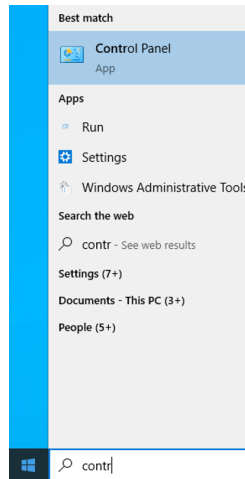

2. Select **Uninstall a program** from the **Programs** menu.

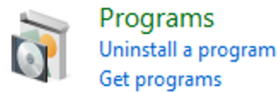

3. Select QIAcuity Software Suite from the list, and click **Uninstall**.

Name	Publisher	Installed On
7-Zip 22.01 (x64)	Igor Pavlov	12/6/2022
AdoptOpenJDK JDK with Eclipse OpenJ9...	AdoptOpenJDK	2/21/2022
DB Browser for SQLite	DB Browser for SQL...	2/6/2023
Git	The Git Developme...	5/17/2023
Google Chrome	Google LLC	8/7/2023
IrfanView 4.62 (64-bit)	Irfan Skiljan	3/14/2023
Microsoft Edge	Microsoft Corporat...	8/12/2023
Microsoft Edge WebView2 Runtime	Microsoft Corporat...	8/13/2023
Microsoft Monitoring Agent	Microsoft Corporat...	12/10/2022
Microsoft OneDrive	Microsoft Corporat...	8/17/2023
Microsoft Visual C++ 2015-2019 Redistri...	Microsoft Corporat...	3/8/2022
Mozilla Firefox (x64 en-US)	Mozilla	6/7/2023
Mozilla Maintenance Service	Mozilla	1/26/2023
Notepad++ (64-bit x64)	Notepad++ Team	12/6/2022
QIAcuity Software Suite	Qiagen	7/27/2023
Qiagen.CommonInterfaces.QIAidentity ...	Qiagen	7/27/2023
Sublime Text	Sublime HQ Pty Ltd	11/4/2022

- In the prompt window asking you if you want to allow changes to your device, click **Yes**.

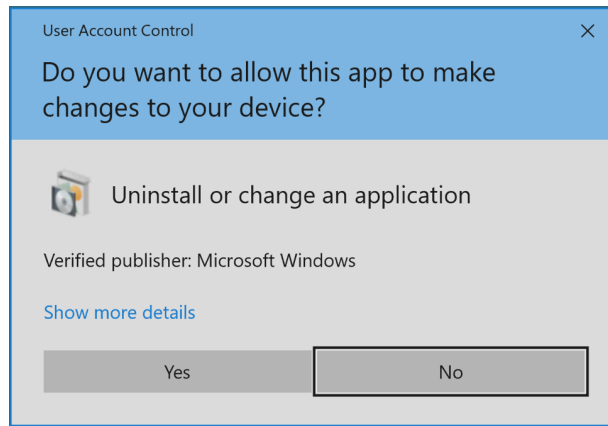

- In the uninstallation wizard, read the description for each action.

Note: The uninstall process will result in database deletion; all plate data will be lost.

- Click the **Uninstall and delete** button, and the QIAcuity Software Suite uninstallation process will start.

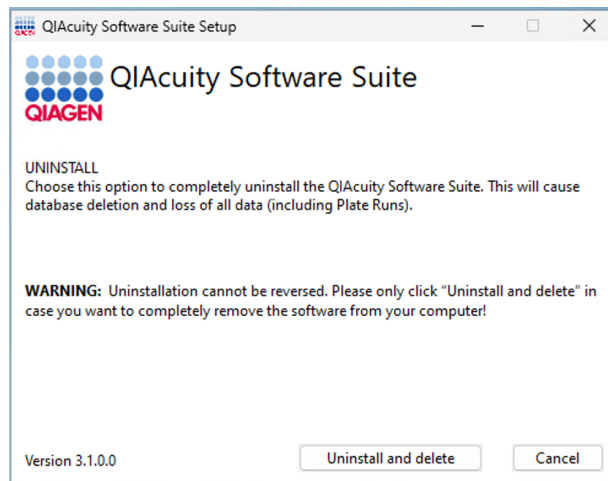

- After uninstallation, click **Restart** in the window asking to restart the device.

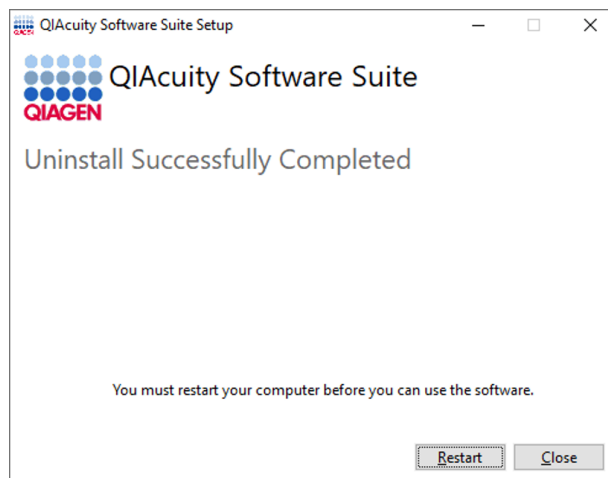

Note: After uninstalling the Software Suite, check the following locations and, if they exist, remove them manually:

- **C:\ProgramData\Qiagen** — Be aware that folder “ProgramData” might be hidden, and the view settings may be needed to be changed in Windows Explorer to see it.
- **C:\Program Files (x86)\QIAcuity Software Suite**
- **C:\Program Files\Qiagen.CommonInterfaces.QIAidentity**

4.7. Updating the instrument software

Note: The latest QIAcuity Software Suite version 3.1 is only compatible with the latest QIAcuity Control Software version 3.1. If only one software component is updated, no connection between the Software Suite and the Control Software can be established.

Important: It is strongly recommended to update the Software Suite first before proceeding with the Control Software.

Note: Only users with an Administrator and Lab Leader role can perform instrument control software updates.

An overview of all available CSW versions with their corresponding Software Suite versions is presented in the table below:

Instrument Control Software version	Compatible Software Suite version
3.1.0.41	3.1.0.0
3.0.0.27	3.0.0.0
2.5.0.24	2.5.0.1
2.2.0.8	2.2.0.26
2.1.8.30	2.1.8.23
2.1.0.41	2.1.7.182
2.0.0.144	2.0.20
1.0.0.84	1.2.18
0.5.2.18	1.1.3

We support the following direct upgrade scenarios:

- From 3.0.0.27
- From 2.5.0.24

All older CSW software versions other than 2.5.0.24 are not supported for a direct upgrade to version 3.1. User needs to update to version 2.5 or 3.0 first.

For the direct update to CSW 2.2.0.8 software version, there is a possibility to do so from version 2.0.0.144, from version 2.1.0.41, or from version 2.1.8.30.

Update from CSW 0.5.2.18 needs an update to CSW 2.0.0.144 first, then update to CSW 2.2.0.8 and only afterwards directly to 3.1.

Update from CSW 1.0.0.84 requires update to CSW 2.1.8.30 first, then update to CSW 2.5 next, followed by direct update to 3.1.

- Visit www.qiagen.com and go to the Software section of the QIAcuity product page to check if an updated software version is available for download.

On a computer running Microsoft Windows, download the software update from www.qiagen.com. Insert the USB drive provided with the QIAcuity, create a new folder named update, and extract the update software into this folder.

It is recommended to clear the data on the instrument first by clicking **Force clear** in **Data Management** under **Tools** before the update.

1. On the Home screen, tap **Configuration**.
2. Select the **System** tab.

Note: The current software and firmware versions are located in the Device Info pane.

3. Connect the USB drive to the instrument.
4. The software version of the update package on the USB is displayed in the Update Info (USB) panel.

Note: If the USB drive is empty, no information is displayed in the Device Info (USB) panel.

Note: Only update to higher versions is possible; updating to identical or lower versions will be prevented.

5. Tap **Update software** to proceed.
6. The Update Flash Controller Software and Firmware window is shown.
7. Tap **Start** to begin the software update or tap **Cancel** to return to the previous window.
8. The update files are copied from the USB drive to the instrument's internal drive. The status of the file copying process is shown on the screen.
Note: If an error occurs when the files are being copied, an error message is shown on the screen. Tap **Cancel** to stop the process. Remove the USB drive and tap **Reboot** to restart the instrument. If the QIAcuity does not function after an unsuccessful software update, contact QIAGEN Technical Services.
9. After the software update files are copied, tap **Reboot** to restart the instrument.
10. The QIAcuity restarts and installs the software and firmware updates, which can take up to 1 hour.
11. **Important:** Valid only for update to versions older than 3.0: When the Control Software was updated before the Software Suite, a restart is required to be able to log in.
12. After the final restart of the instrument, the network icon and the Software Suite icon should be green and you may login with the admin credentials previously defined in the QIAcuity Software Suite.
 - a. If the Software Suite is not yet connected, login in with the SetupUser credentials.
 - b. Check your Software Suite settings. If all settings are configured correctly, press **Test Connection** and **Save**.
 - c. Once the Software Suite is detected, a pop-up will state that a new Software Suite was detected and a restart is needed.
 - d. Restart the instrument.

- e. After restarting the instrument, the connection between the instrument and the Software Suite is established and you may login with the admin credentials previously defined in the QIAcuity Software Suite.

13. Repeat steps 1–12, if additional update is necessary.

4.8. Establishing a connection between the QIAcuity instrument and the QIAcuity Software Suite

The QIAcuity instrument needs to be connected to the QIAcuity Software Suite to enable the exchange of data for the analysis and configuration of the instrument. An established connection enables the QIAcuity Software Suite to set up plates, analyze results, and monitor the status of runs in real time. Depending on the customer requirements, the connection can be realized in different configurations, as shown in the following sections.

4.8.1. Private LAN direct connection of one instrument to a co-located Software Suite computer

For this, the QIAcuity instrument and the QIAcuity Software Suite may be connected via an ethernet cable between the QIAcuity and the notebook where the QIAcuity Software Suite is running.

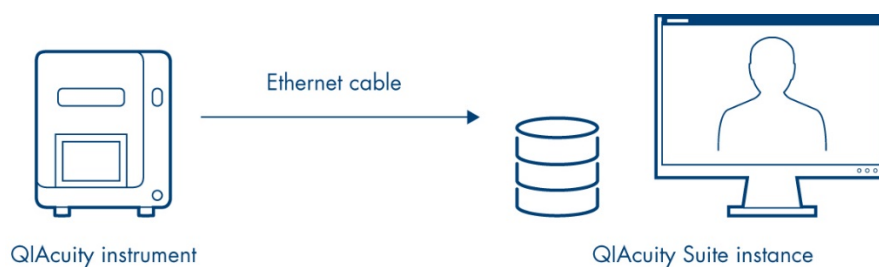

Figure 1. The QIAcuity instrument and QIAcuity Software Suite are directly connected via Ethernet cable.

4.8.2. Instrument and Software Suite computer connection via LAN

Alternatively, both the QIAcuity instrument and the computer running the QIAcuity Software Suite can be connected to a local area network (LAN). This configuration allows the QIAcuity notebook or a separate computer to work as a server to which multiple clients can be connected.

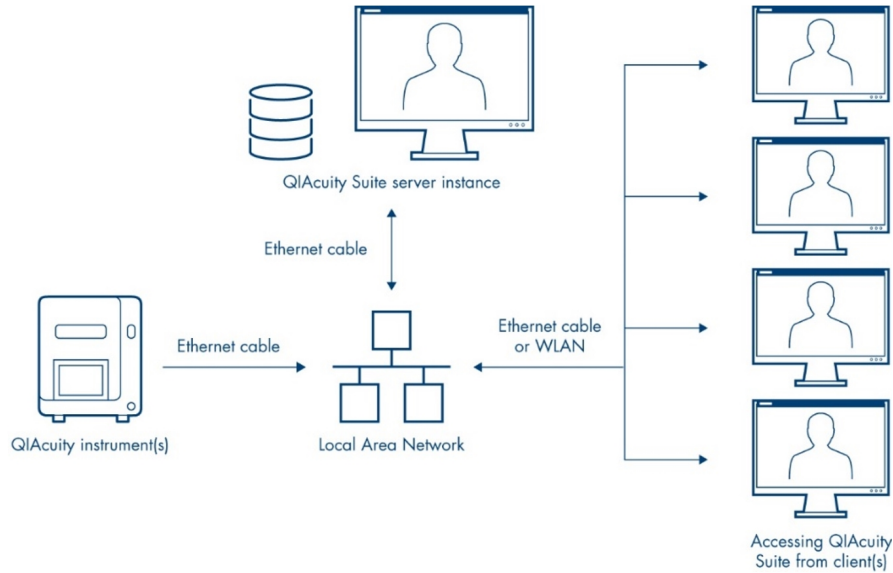

Figure 2. The QIAcuity instrument(s) and QIAcuity Software Suite are installed to a network, allowing multiple clients to access the QIAcuity instrument(s) via a single QIAcuity Software Suite server.

For connection to the Software Suite server, use the IP address of the Software Suite server.

4.8.3. Private LAN with multiple instruments connected to a Software Suite computer

Using a switch between the instrument and the Software Suite instance allows connection of multiple instruments to one suite server in a private LAN environment.

4.8.4. Instrument in dedicated subnet with computer also connected to corporate LAN

A connection of the instrument in an isolated network via a direct ethernet cable connection to QIAcuity Software Suite server while the QIAcuity Software Suite server itself is connected via another interface (ethernet or wireless LAN) to customer's LAN (Intranet) allows the client workstations to access the QIAcuity Software Suite via the respective LAN (Intranet).

For the instrument connection to the QIAcuity Software Suite server, the explicit IP address configuration for the QIAcuity Software Suite server ethernet adapter has to be used. The client workstations use the IP address of the QIAcuity Software Suite server of either the WLAN or second ethernet adapter.

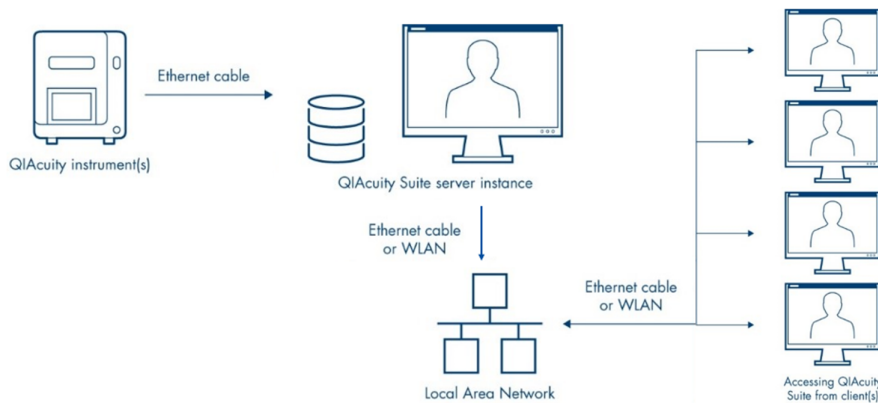

Figure 3. The QIAcuity instrument and the QIAcuity Software Suite can also be operated in two separate networks, allowing multiple clients to access the QIAcuity instrument via a single QIAcuity Software Suite server, while maintaining instrument network isolation.

4.8.5. Configuring an ethernet connection between the QIAcuity instrument and the QIAcuity Software Suite

Important: Only users with an Administrator role can modify the network configuration. Consulting your network administrator when configuring the network is recommended.

To establish a connection, the instrument and the notebook must be connected to the LAN. For 10 users accessing the system in parallel, the requirement is a minimum data connection speed of 10 Mbit/s for a setup via network. For the time synchronization between the instrument and the notebook, Windows Time Service (NTP) is used. Please make sure that above service is enabled on the notebook or contact your administrator.

Note: Make sure that the QIAcuity instrument is connected to the LAN. Any other configurations are not supported by QIAGEN.

For communication with the QIAcuity Software Suite, the following ports are used and should be always opened in the correct direction:

- The inbound TCP port 44321
- The inbound TCP port 8080
- The inbound TCP port 8687
- The inbound UDP port 123

After any changes are applied to the ports above, the QIAcuity instrument must be restarted.

Pinging the network is also supported.

Note: If the connection with the instrument from direct to LAN or from LAN to direct has been changed or the IP was reassigned, refer to point (d) under the “Installation and maintenance” subsection of “Troubleshooting the instrument and software” section.

Follow the steps below to configure the notebook running the QIAcuity Software Suite in Windows 10 or 11.

1. Go to the **Control Panel** app.

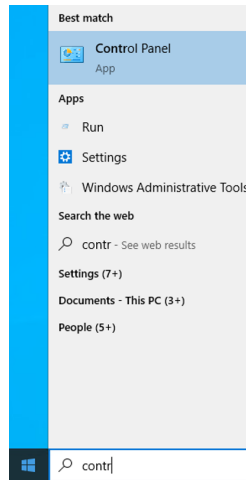

2. Click **Network and Internet** (if not available, proceed to the next step).

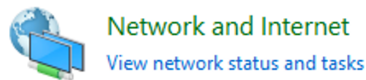

3. Click **Network and Sharing Center**.

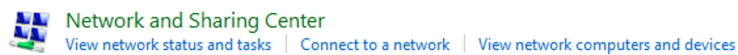

4. On the left pane, click **Change adapter settings**.

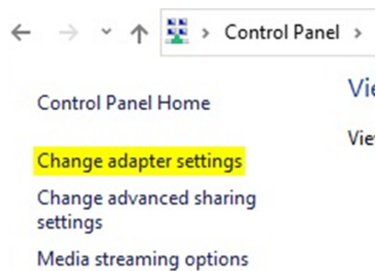

5. Right-click the ethernet network adapter and select **Properties**.

6. Select **Internet Protocol Version 4 (TCP/IPv4)** and click **Properties**.

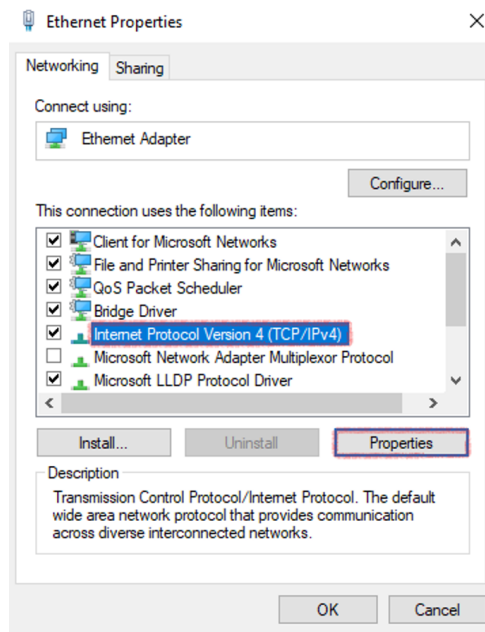

7. Select **Obtain an IP address automatically**. If your organization does not provide DNS details, select **Obtain DNS server address automatically as well**. Click **OK**, then **Close**.

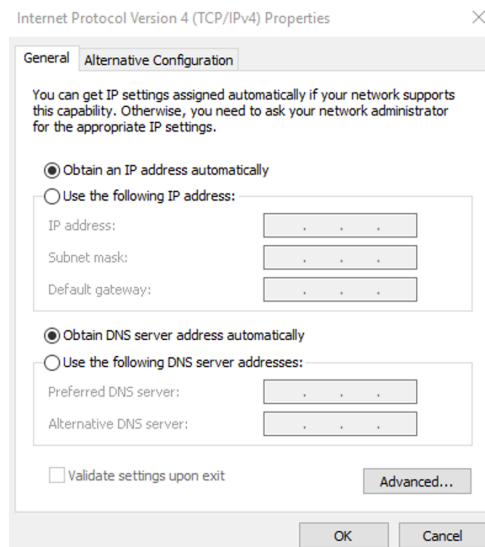

Optional: You can check if the addresses have been assigned properly by following the steps below.

- From your Home screen, click the **Search** icon. Enter "cmd" and press the **Enter** key.
- Wait for the command line window to open. Enter "ipconfig".
- The address should be visible under the ethernet interface name for which modifications were made.

In Windows 11, refer Microsoft support page – [Change TCP/IP settings - Microsoft Support](#) – to get guidance for the recent version.

Follow the steps below to configure the QIAcuity instrument network settings.

1. Log into the instrument using the following credentials:
 - **Login:** SetupUser
 - **Password:** 2#ConnectSuite
2. On the toolbar, tap **Configuration**.
3. Select the **Ethernet** tab.

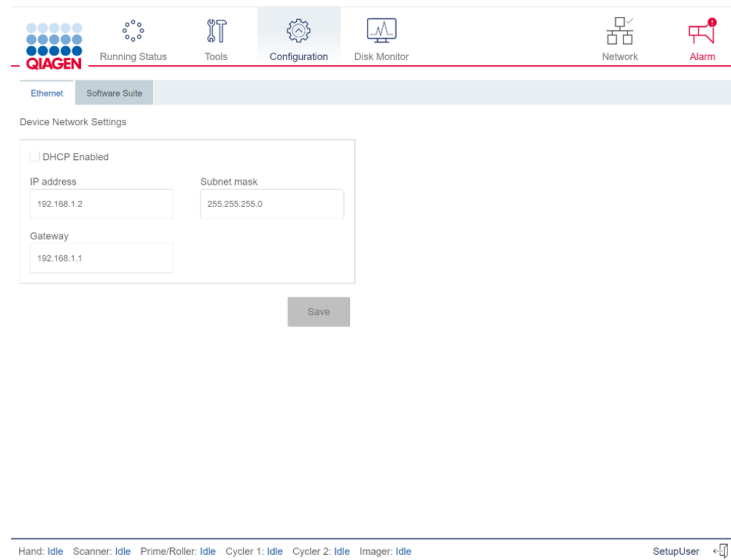

4. Check the "DHCP Enabled" box. If this box is ticked, the "IP address" and "MAC address" fields are disabled. The assigned IP and MAC addresses of device are displayed in the "IP address" and "MAC address" fields. Alternatively, the customer's IT may configure a fixed IP address for the instrument.

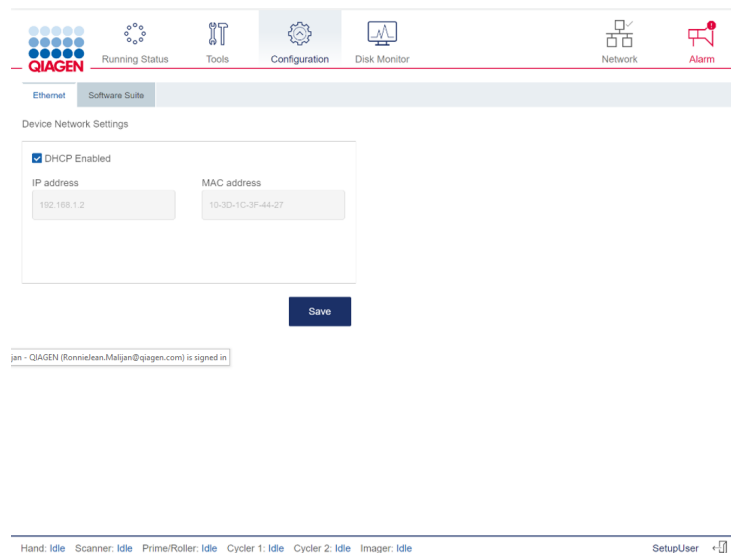

5. Tap **Save**.

4.8.6. Configuring a direct cable connection between the QIAcuity instrument and the QIAcuity Software Suite

Note: Before you start, ensure that the QIAcuity instrument and the notebook are connected with an Ethernet cable.

Follow the steps below to configure the notebook running the QIAcuity Software Suite in Windows 10.

1. Go to the **Control Panel** app.

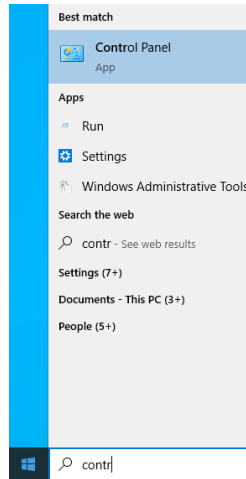

2. Click **Network and Internet** (if not available, proceed to the next step).

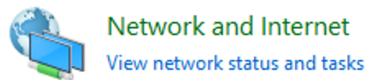

3. Click **Network and Sharing Center**.

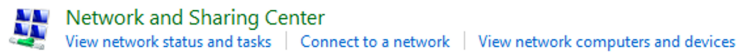

4. On the left pane, click **Change adapter settings**.

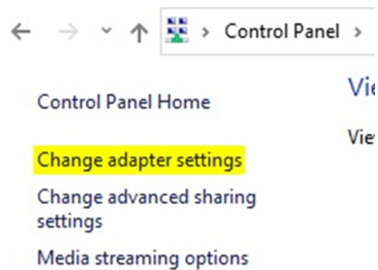

5. Right-click the ethernet network adapter, and select the **Properties** option.

6. Select **Internet Protocol Version 4 (TCP/IPv4)**, and click **Properties**:

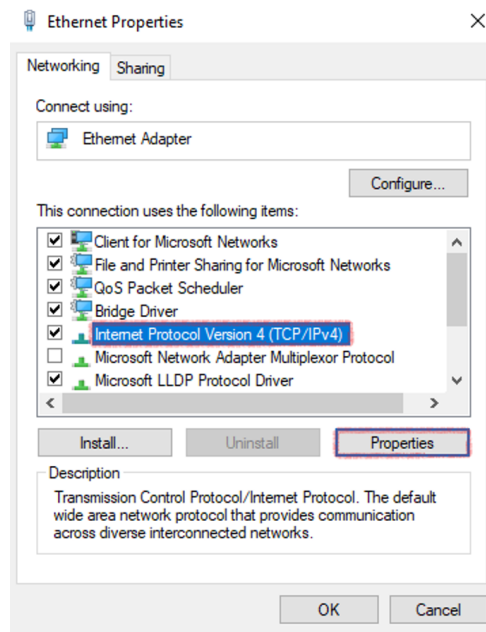

7. Select Use the following IP address. Enter the following information:

- **IP address:** Enter "192.168.1.1".
- **Subnet mask:** Enter "255.255.255.0".
- **Default gateway:** Enter "192.168.1.254".
- **Preferred DNS server:** Enter the DNS server address.
- **Alternative DNS server:** Enter the alternative DNS server address.

Note: If the "Preferred DNS server" and "Alternative DNS server" fields are left blank, the connected is showed as unknown.

8. Click **OK**, then click **Close**.

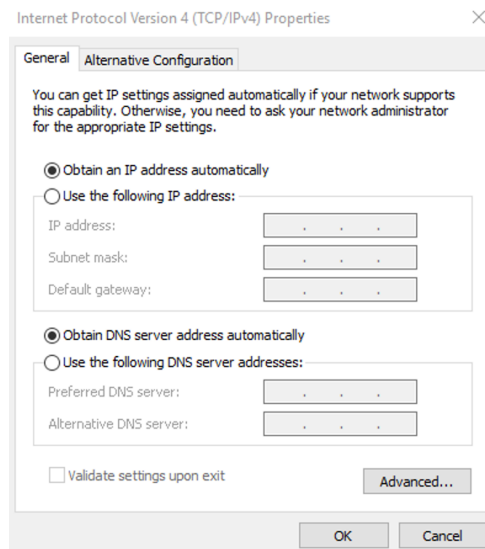

Optional: You can check if the addresses have been assigned properly by following the steps below.

- a. From your Home screen, click the **Search** icon. Enter "cmd" and press the **Enter** key.
- b. Wait for the command line window to open. Enter "ipconfig".

The address should be visible under the ethernet interface name for which modifications were made.

In Windows 11, refer Microsoft support page – [Change TCP/IP settings - Microsoft Support](#) – to get guidance for the recent version.

Follow the steps below to configure the QIAcuity instrument.

1. On the toolbar, tap **Configuration**.
2. Select the **Ethernet** tab.

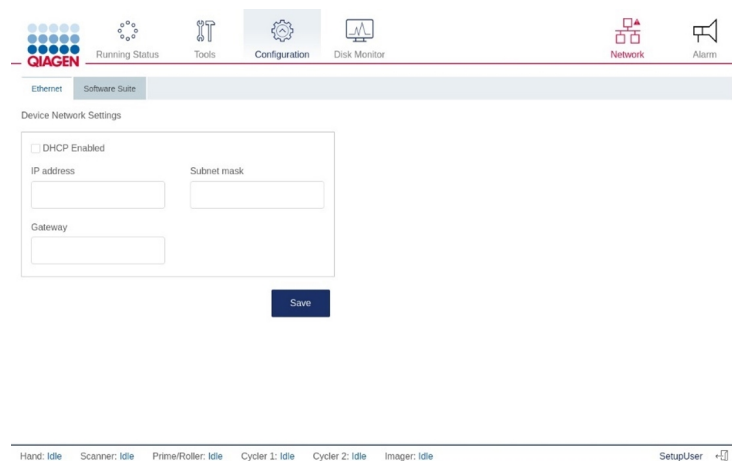

3. Ensure that the "DHCP Enabled" box is not checked. Enter the following information:
 - **IP address:** Enter "192.168.1.2".
 - **Subnet mask:** Enter "255.255.255.0".
 - **Gateway:** Enter "192.168.1.1".

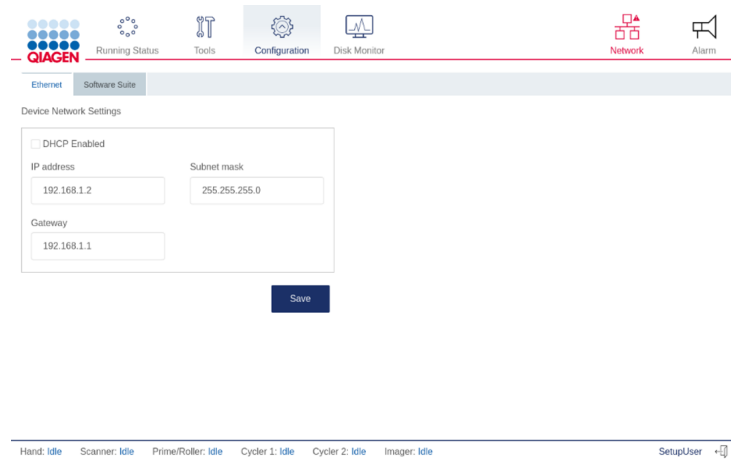

4. Tap **Save**.

4.8.7. Configuring the connection to the QIAcuity Software Suite in the QIAcuity instrument software

The QIAcuity instrument needs to be connected to the QIAcuity Software Suite to enable the exchange of data. To establish a connection, the instrument and the device in which the QIAcuity Software Suite is running must be connected to the same network.

Note: A plate run can only be performed if the QIAcuity Software Suite is connected to the instrument through a network or direct cable connection to the QIAcuity Software Suite server.

To connect the instrument to the QIAcuity Software Suite:

1. The **Network** icon represents the connection between the QIAcuity Software Suite and the instrument. When the icon is red, the connection is not established.
2. Log into the Instrument using the following credentials:
 - **Login:** SetupUser
 - **Password:** 2#ConnectSuite

Note: SetupUser is only allowed to log into the instrument when connection with the Software Suite is not established. Once established, login with SetupUser is no longer possible.

3. On the Home screen, tap **Configuration**.

4. Tap the **Software Suite** tab.

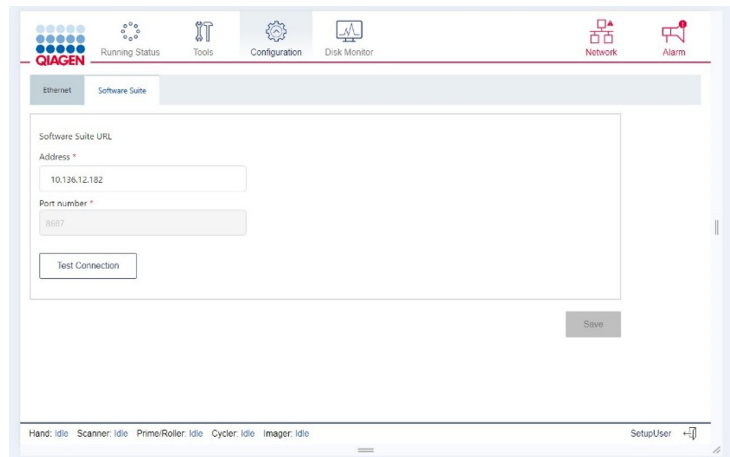

5. Enter the IP address in the address field of the **Software Suite URL** section.

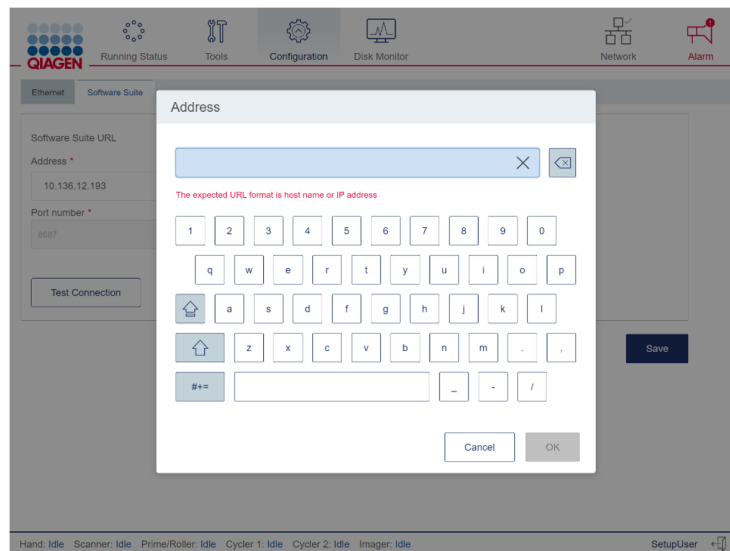

Note: To obtain the IP address of the Suite Server, the instrument must be connected to the Suite Server. From the home screen on the Suite PC, click the **Windows** icon and navigate to Command Prompt, or enter "cmd" in the search field. A command line window appears. Enter "ipconfig" to view the network settings.

Due to technical limitations, Suite Server IP address shall not contain the full IP of the instrument (e.g., instrument IP set to xxx.xxx.xxx.12 will not work correctly with Suite Server IP xxx.xxx.xxx.123; in that case the latter value should be changed, e.g., to xxx.xxx.xxx.13). This requires a new IP address assignment of the Software Suite laptop/network. Afterwards, the new IP address needs to be entered in the address field of the **Software Suite URL** section.

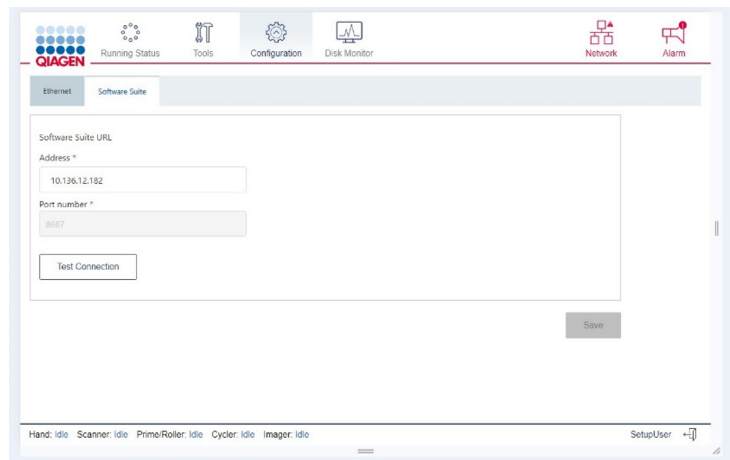

Note: An error message displays if the address and port number you entered are invalid. Tap **OK** to close the error message, and then re-enter the correct address and port number in the address field in the Software Suite URL area.

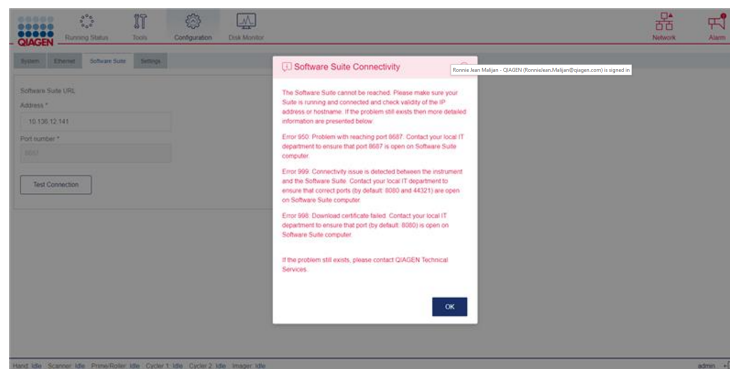

6. Tap **Save**.

4.9. Getting started with the QIAcuity

4.9.1. Configuration of the QIAcuity

If you are using QIAcuity for the first time, we recommend that you define the required settings. Other settings can be changed later, when needed.

For more information about using the touchscreen and software, refer to the “Operating the QIAcuity Instrument ” section.

4.9.2. Procedure

1. Make sure that the rear power switch is set to “I”.

Press the front power button to turn on the instrument.

2. The startup screen appears on the touchscreen. Wait until the initialization tests are finished.

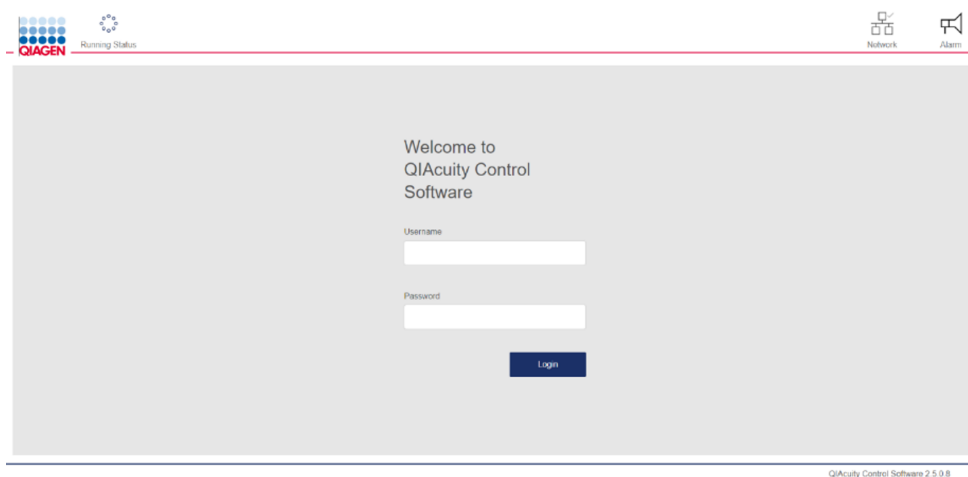

3. Enter the following initial login information in the Login page. Tap the field to begin typing.

- **User ID:** admin
- **Password:** admin

Note: The default admin user account is available once connection to the Software Suite is established following the steps described in section “Configuring the connection to the QIAcuity Software Suite in the QIAcuity instrument software”.

4. Tap **Login** to continue.

5. The Home screen appears.

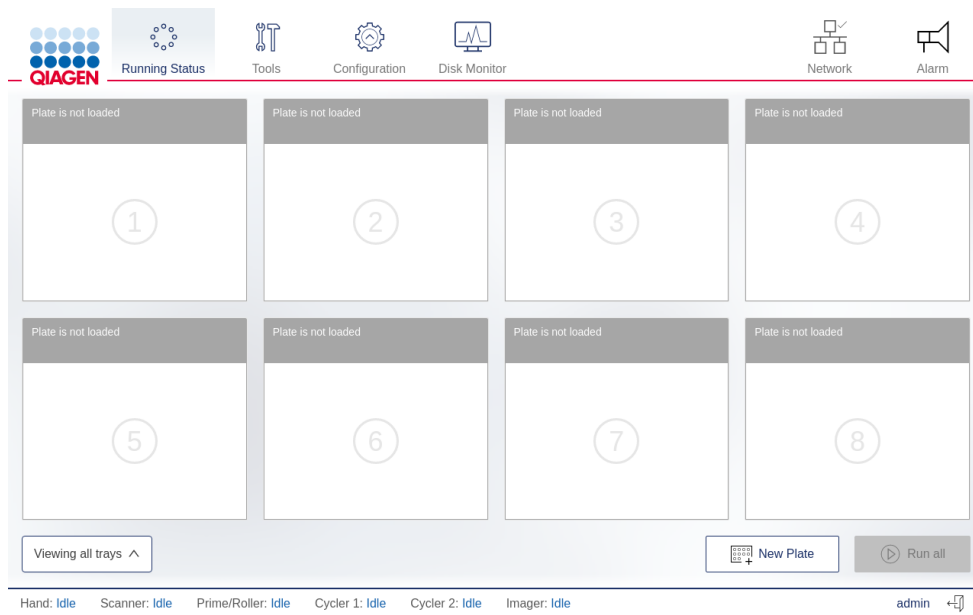

Note: To return to the Home screen from another screen, tap **Running Status**.

4.9.3. Setting basic system data

This section describes how to set the preferred name for the instrument.

To set the preferred QIAcuity name

1. On the Home screen, tap **Configuration**.
2. Select the **System** tab.
3. Specify your preferred instrument name in the "Device Name" field. If this field is left blank, a default name is automatically generated for each QIAcuity instrument.

Note: Names can have up to 24 characters: letters A–Z, a–z, 0–9, and a hyphen (-). Do not start the instrument name with a digit or a hyphen. Instrument names also cannot end with a hyphen.

4. The default device name uses the following naming convention: QIAcuity-<serial number of the instrument>.

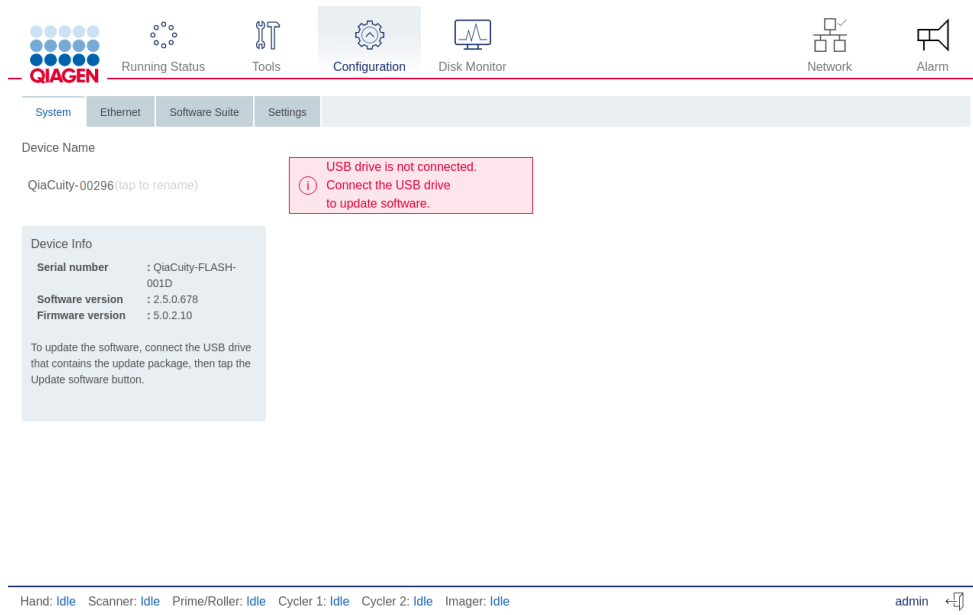

4.9.4. Managing users

The QIAcuity requires users to log in before accessing instrument functionalities. Each user must have a user account with an appropriate role assigned to it. The QIAcuity supports various pre-designed user roles and customer-created user roles. Each role has different access rights to QIAcuity functions described in section “Log-in screen”.

4.9.5. Access policy

Password expiration

Since version 2.1, after 30 days, passwords expire and every user (except the user with login "admin" provided automatically by QIAcuity Software Suite installation) is prompted for password change. After software update, during first attempt to login into an instrument, the user is informed about the need to update the password in the Software Suite. Once at least an additional user with administrator rights has been created, it is recommended to deactivate the initial default admin user (for which password does not expire).

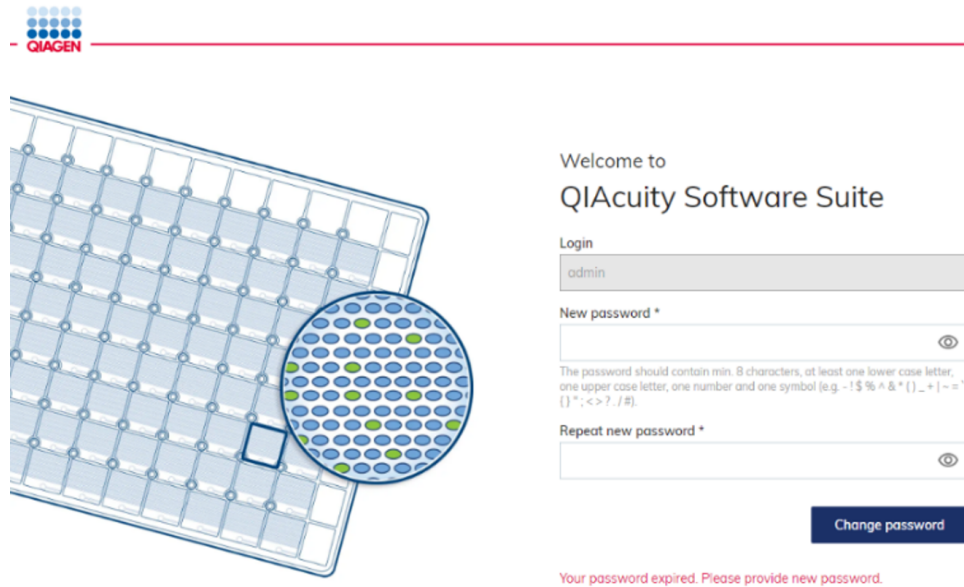

The image shows a screenshot of the QIAcuity Software Suite login interface. On the left, there is a stylized graphic of a QIAcuity instrument plate with a circular inset showing a magnified view of the wells. The top left corner features the QIAcuity logo, which consists of a grid of blue dots above the word "QIAGEN" in red. The main content area is titled "Welcome to QIAcuity Software Suite". Below the title, there is a "Login" section with a text input field containing "admin". Below that is a "New password *" section with a text input field and a toggle icon. A small text box below the password field states: "The password should contain min. 8 characters, at least one lower case letter, one upper case letter, one number and one symbol (e.g. -!\$% ^ & * { } _ + | ~ = ' { } * ; < > ? . / #)". Below this is a "Repeat new password *" section with another text input field and a toggle icon. A dark blue button labeled "Change password" is positioned below the repeat password field. At the bottom of the screen, a red error message reads: "Your password expired. Please provide new password."

Automatic log-off and blocking user account

QIAcuity Software Suite automatic log-off and user account blocking:

- After three unsuccessful login attempts, a user is temporarily blocked and needs to wait 10 minutes to unblock the account.

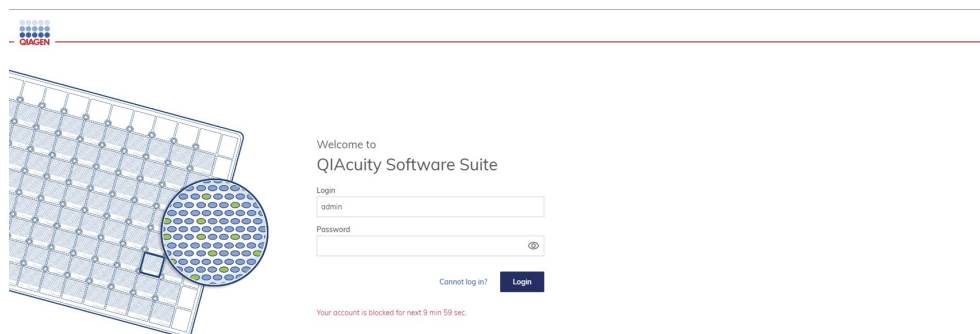

- In case of 15 minutes of inactivity, users are automatically logged off. Activity consists of mouse clicks, mouse scrolling, and pressing buttons on the keyboard (mouse movement without clicks nor scrolling is not considered as activity). This behavior applies even when user operates the application on multiple browser tabs– the aforementioned activities are registered on any of the opened windows. Automatic log off happens on all opened tabs in the application, and user is redirected to the default login page. When users login again, the application will automatically redirect the user to the last page where log-off occurred.

Automatic log off does not interrupt plate operations such as, for example, plate upgrade. When some plate operations are triggered and automatic log-off occurs in the meantime, the operation will be continued in the background and results will be available after the next log-in.

4.9.6. Synchronizing labware with the QIAcuity Software Suite

The QIAcuity Control Software and the QIAcuity Software Suite use labware files that include information about the Nanoplate formats available. A labware file defines dimensional specifications and default processing parameters for each Nanoplate. Information about the labware used by the QIAcuity can be downloaded from the Software Suite. The labware data are synchronized automatically when the instrument is turned on and the connection to the Software Suite is established. You can also synchronize it manually by clicking **Tools** and selecting **Labware Sync**. The labware is then downloaded and updated.

Note: Only users with appropriate rights are allowed to synchronize labware.

Note: Make sure that, after the first successful Software Suite connection, the instrument is restarted to allow automatic synchronization of labware files.

Note: The connection between the QIAcuity and the Software Suite must be configured before starting this procedure. For more information on how to set up the connection, refer to section “Establishing a connection between the QIAcuity instrument and the QIAcuity Software Suite”.

To download labware information from the Software Suite, follow the steps below.

1. On the toolbar, tap **Tools** and then proceed to the **Labware Synchronization** tab.

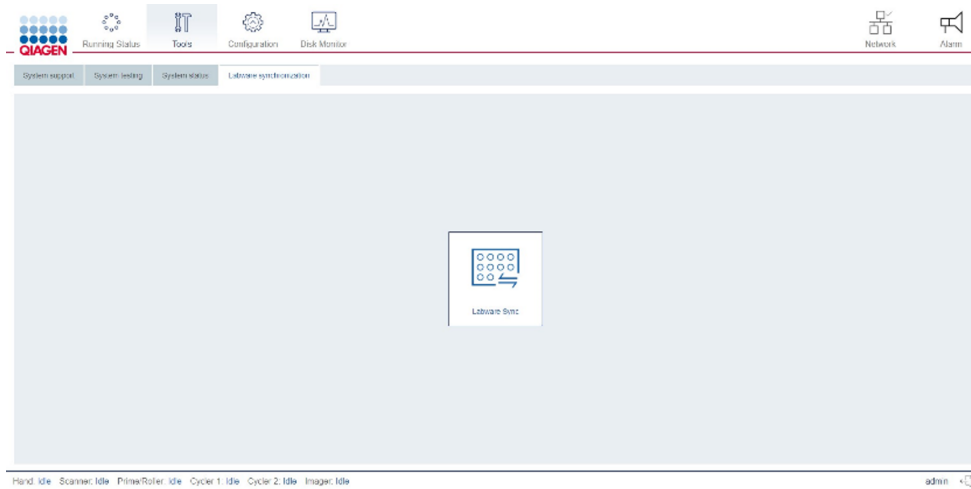

2. Tap **Labware sync**. The Labware synchronization dialog box appears.
3. The progress of the download is shown in the dialog box. Once the synchronization is complete, tap **OK** to finish the process.

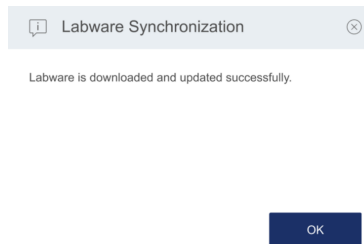

5. Operating Plates

In the QIAcuity plate-based system, one reaction mix per well is partitioned into a large number of individual partitions prior to the amplification step, resulting in one or very few templates being present in each partition. QIAGEN offers different plate types according to specific user needs.

Table 4. Plate types according to user needs

Plate type	Frame color	No. of wells	Input volume/well (µL)	No. of partitions	Partition volume (nL)
Nanoplate 26K 24-well	Blue	24	40	Approx. 26,000	Approx. 0.82
Nanoplate 26K 8-well	Light blue	8	40	Approx. 26,000	Approx. 0.82
Nanoplate 8.5K 24-well	White	24	12	Approx. 8500	Approx. 0.34
Nanoplate 8.5K 96-well	Gray	96	12	Approx. 8500	Approx. 0.34

Note that the QIAcuity Software Suite calculates with a partition volume of 0.82 or 0.34 nL, depending upon Nanoplate type, in cases where the VPF (volume precision factor) has not been applied. If the VPF has been loaded to the software, the volume of each well is Nanoplate batch-specific calibrated and used for concentration calculation. Thus, the concentration calculated by the QIAcuity Software Suite will differ to concentration values calculated manually.

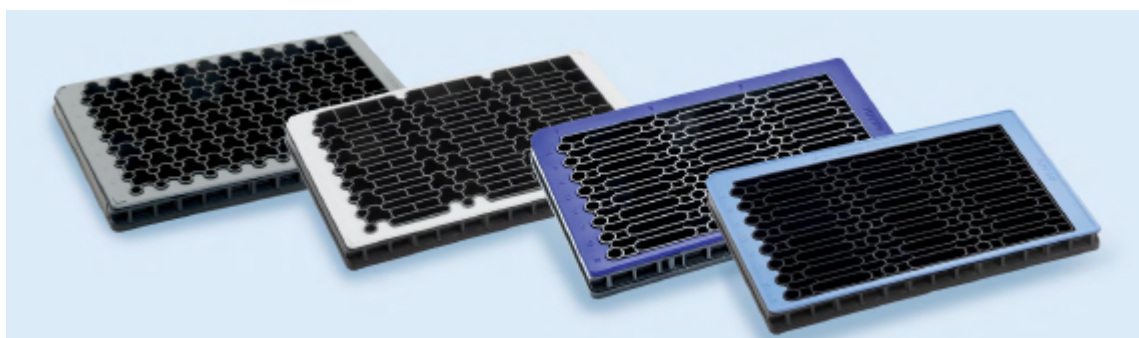

Image of Nanoplate 26K 24-well, Nanoplate 8.5K 24-well, and Nanoplate 8.5K 96-well.

5.1. QIAcuity Nanoplate 26K 24-well

For applications requiring high sensitivity, QIAGEN offers the 26K nanoplate. In this plate, one reaction mix is distributed over 4 wells and separated into approximately 26,000 partitions. The plate may be used for up to 24 samples and has a blue frame as distinction from the other plates.

The key applications of the 26K nanoplate are:

- Rare mutation detection
- Liquid biopsy

5.2. QIAcuity Nanoplate 26K 8-well

For applications requiring high sensitivity, QIAGEN offers the 26K nanoplate. In this plate, one reaction mix is distributed over 4 wells and separated into approximately 26,000 partitions. The plate may be used for up to 8 samples and has a light blue frame as distinction from the other plates.

The key applications of the 26K nanoplate are:

- Rare mutation detection
- Liquid biopsy

5.3. QIAcuity Nanoplate 8.5K 24-well

In this plate, one reaction mix is distributed in 1 well and separated into approximately 8500 partitions. The plate is recommended for applications using low input volumes and a small number of samples. The plate may be used for up to 24 samples and has a white frame as distinction from the other plates.

The key applications of the 8.5K nanoplate are:

- CNV detection
- NGS library quantification

5.4. QIAcuity Nanoplate 8.5K 96-well

In this plate, one reaction mix is distributed in 1 well and separated into approximately 8500 partitions. This plate is recommended for applications using low input volumes and a large number of samples. The plate may be used for up to 96 samples and has a gray frame as distinction from the other plates.

The key applications of this nanoplate are:

- CNV detection
- NGS library quantification

5.5. Reaction setup

Note: The QIAcuity reads fluorescence from the bottom of the Nanoplate, which is covered with a seal. For best results, keep the foil clean and avoid damages such as scratches. Also, keep the barcode on the side of the Nanoplate clean and intact. Ensure that you wear gloves when working with a Nanoplate and do not apply force to it.

For better handling of the Nanoplate, you can place it into the Nanoplate tray that can be ordered as an accessory, see Appendix B — QIAcuity Accessories or the QIAcuity webpage on www.qiagen.com

To set up a plate, follow these steps:

1. Prepare your master mix according to your reaction setup. To prepare the reaction mix without sample, the QIAcuity PCR master mix has to be mixed with primers, RNase-free water, and optionally restriction enzyme and probes according to the kit manual. The final volume depends on the QIAcuity Nanoplate that is used (refer to Table 4).

Note: To prevent non-homogeneous reaction mixes, set up in a standard PCR pre-plate is required. The calculated reagent volumes must be pipetted into the PCR pre-plate, and then the sample added accordingly. For homogenous mixing of reaction mix, the pre-plate must be sealed, shortly vortexed, and briefly centrifuged.

Note: Enzymatic fragmentation of DNA larger than 20 kb ensures even distribution of template throughout the QIAcuity Nanoplate, which in turn leads to accurate and precise quantification. Therefore, adding a restriction enzyme depends on the template used. In case of enzymatic fragmentation using the recommended restriction enzymes, the pre-plate has to be incubated at room temperature (RT) for 10 minutes. Longer incubation does not lead to unspecific restriction and therefore has no impact on the result. Refer to the Application Guide on www.qiagen.com for the recommended restriction enzymes.

Important: Do not pipet master mix and sample separately into the Nanoplate as this will lead to insufficient mixing.

2. Pipet each reaction mix from the pre-plate into a well of the Nanoplate. If possible, use an electric one-channel pipette. To ensure bubble-free pipetting, we recommend to pipette 39 μ L for Nanoplate 26K 8/24-well, and 11 μ L for Nanoplate 8.5K 96/24-well of your prepared reaction mix to the bottom of the respective input well of the Nanoplate. Ensure not to pipet into the output well instead of the input well.

Note: To avoid damaging the optical surface and to reduce dust that will interfere with the imaging and analysis of results, we recommend placing the Nanoplate into a Nanoplate tray before pipetting the reaction mix into the Nanoplate.

Note: Do not centrifuge the Nanoplate as this will lead to pre-priming and insufficient filling of the wells.

Note: Do not vortex the Nanoplate as this will lead to insufficient filling of the wells.

3. Apply the plate seal that comes with the Nanoplates as follows to ensure good filling of the wells and to prevent evaporation and contamination:
4. The stiff plate seal consists of a plate seal and two protective sheets. The three-layered seal should not be folded. Remove the bottom white protective sheet carefully, and then center and align the plate seal (still containing the upper protective sheet) with the lower edge of the colored frame of row H. The seal should not overlap on any side more than 1 mm, otherwise the Nanoplate might not be processed by the instrument. In case the plate seal is incorrectly placed or the seal does not cover some parts of the Nanoplate, carefully remove this seal and repeat the entire sealing step with a new one. Correct sealing of the Nanoplate prevents samples from not being fully processed.

Note: It is recommended to cover the plate with the top seal within 30 minutes after pipetting to prevent subsequent filling issues.

Note: Keep the plate seals stored in a dry, darkened, and air-free environment by always completely closing them inside the provided storage bag in which they came, and storing them in the Nanoplate box.

5. After correct placement, the plate seal must be fixed with the Nanoplate roller in both the horizontal and vertical directions.
6. Afterwards, the upper protective sheet is removed from the bottom left corner. Hold the rubber seal in place on the plate corner with one finger while the upper transparent sheet is being pulled off. If the upper sheet is removed in another direction, the plate seal might loosen.
7. Use the Nanoplate roller with high force to fix the plate seal on the Nanoplate by rolling at least three times forwards and backwards in a horizontal direction, and then three times forwards and backwards in the vertical direction over the edge of the plate. Roll over the plate seal covering the Nanoplate frame. The proper fixing of the plate seal is important for a good filling of the wells.

Note: For a properly sealed plate, the plate seal covers the whole structure, and no bubbles or strong depressions are visible, as this can also lead to poor filling.

8. The plate frame gives the option to mark the plate with a marker pen. Use the lane between the plate edge and the printed letters (next to column 1) as well as the mirrored portion (from column 12 to the plate edge) only. Marking the plate seal directly on top of each well is not recommended as it might lead to poor filling.

Important: Do not mark the bottom side of the plate, as it is used to read fluorescence signals.

Note: Ensure that overlapping parts of the plate seal are turned down and attached to the plate frame and that the barcode is not covered. Do not apply pressure to either the upper or lower plate seal.

9. For the transport of the Nanoplate to the QIAcuity instrument, the plate should be held at the side edges or on the tray horizontally. Make sure that the plate is transported to the QIAcuity smoothly without shaking or turning over the plate to ensure that the reaction mix remains at the bottom of the input well.
10. The plate can now be used to start a run. For more information about starting a run on the QIAcuity, see section "Operating the QIAcuity Software Suite".

Note: Do not store the plate for more than 2 hours before the start of a run as this may lead to pre-priming of the reaction mix resulting in reduced number of analyzable partitions.











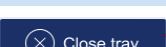

11. If the plate is kept in the dark, avoiding exposure to moving air (e.g., storage in a dark box), you can store the plate after the run for up to 1 week at room temperature or at 4°C. (**Note:** Storage time may be reduced from 1 week to shorter durations due to various factors, such as dye/probe stability, master mix, and previous imaging step/settings). Dispose the plates after seven days at the latest. A plate can be re-imaged up to six times (seven total imaging steps); see "Setting up an experiment" section for more information on how to re-cycle and re-image a plate.

Note: For improperly stored plates, the fluorescence intensity and plate seal integrity can be affected, which could lead to contamination of the laboratory. Store processed plates according to these guidelines or dispose of them properly after the process.

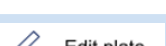
6. Operating the QIAcuity Instrument

The QIAcuity is operated through a touchscreen. Elements of the QIAcuity user interface are shown in the following table.

Table 5. QIAcuity interface elements

Button/Icon	Function
	Starts the run
	Stops the run
	Starts runs on all loaded plates
	Stops all runs
	Closes an open tray
	Ejects selected tray
	Displays an additional menu
	Enables the user to edit plate parameters
	Enables the user to create a new plate and specify its parameters
Text field	Enables to enter or edit a value using the on-screen keyboard
	Logs the user out
	Indicates whether the instrument is connected to a network
	Landing page with status of runs
	Configuration
	Tools

6.1. Entering text and numbers

To enter text or numbers, tap the corresponding field. An on-screen keyboard is displayed on the touchscreen.

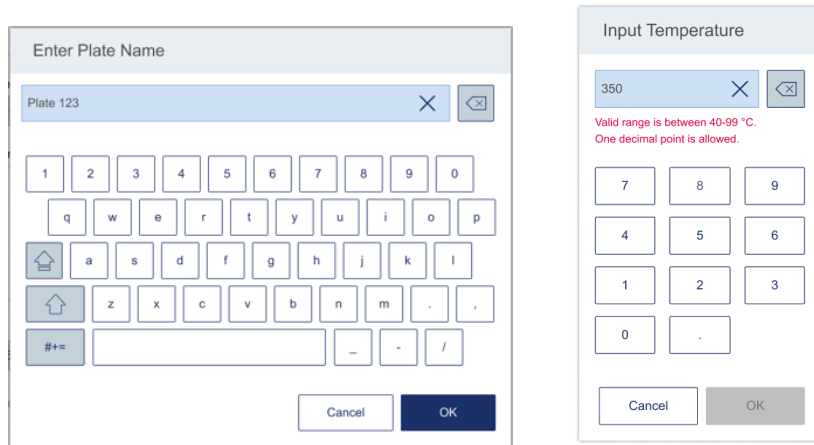

In some cases, the value required in a text field must meet a specific criterion. If required, the criteria are specified in the corresponding input window.

Note: For all text fields, a handheld scanner plugged into one of the USB-ports can be used to scan 1D barcodes. Buttons and icons related to the on-screen keyboards are shown in the following table. An external keyboard can also be attached via USB port for data entry, if desired.

Table 6. On-screen keypad buttons and icons

Button/Icon	Function
	Removes one character to the left of the cursor
	Clears the field
	Enables the user to type one uppercase letter. After the letter is typed, the keyboard will show lowercase letters again.
	Switches to uppercase letters. Allows the user to type multiple uppercase letters. To return to lowercase letters, press the symbol again.
	Shows special characters
	Shows alphanumeric characters
	Confirms the input and closes the window
	Discards the input and closes the window

If the entered value is not correct, the border of the textbox changes to red and additional information about the field's requirements is shown. The input cannot be confirmed until the value entered in the box meets the requirements.

6.2. Turning on the instrument and logging in

To turn on the instrument and log into the software, follow these steps:

1. Press the **Power** button to turn on the QIAcuity.
2. The startup screen appears on the touchscreen, and the instrument automatically performs initialization tests. After the initialization setup, the Login window appears.
3. Enter your credentials in the "Username" and "Password" fields.

Note: The "Username" field is case sensitive.

Note: When connection to the Software Suite has not been established yet, log into the instrument using the following credentials:

- **Login:** SetupUser
- **Password:** 2#ConnectSuite

For further information, refer to section "Configuring the connection to the QIAcuity Software Suite in the QIAcuity instrument software".

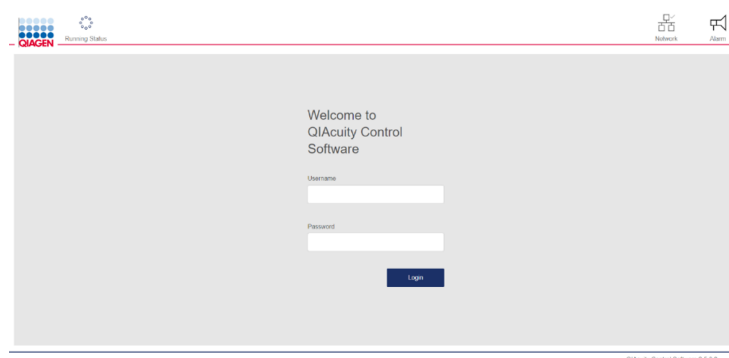

4. Tap **Login**.
5. The Home screen displays.

Note: If the username does not match the password or if the username does not exist, an error message is displayed on the screen. Re-enter the correct credentials in the "Username" and "Password" fields.

6.3. Setting up a run

Before starting a run, at least one plate must be created, and its name, plate type, and dPCR parameters must be defined. We recommend that you define plates and their specific parameters (e.g., the run profile) using the QIAcuity Software Suite. For more information about setting up a plate using the QIAcuity Software Suite, refer to "Operating the QIAcuity Software Suite" section. For creating a plate using the plate configurator of the instrument software, refer to "Plate configuration procedure" section.

6.4. Setting up an experiment

Note: A plate run can only be performed if the instrument is connected to the QIAcuity Software Suite either through a network or a direct cable connection to the QIAcuity Software Suite server.

Note: It is recommended to cover the plate with the top seal within 30 minutes after pipetting to prevent subsequent filling issues.

6.4.1. Loading the trays and starting a run

The Home/Running status screen shows the current status of the trays and the slots inside them. If there are no plates loaded in the instrument, the screen displays empty panes and each pane displays the **Plate is not loaded** label. You can load up to eight plates at one time with QIAcuity Eight, up to four plates at one time with QIAcuity Four, and one plate with QIAcuity One.

Note: Loading and unloading plates during a run is supported by QIAcuity Eight and QIAcuity Four. To learn more about continuous loading and unloading, refer to section “Continuous loading and unloading of plates”.

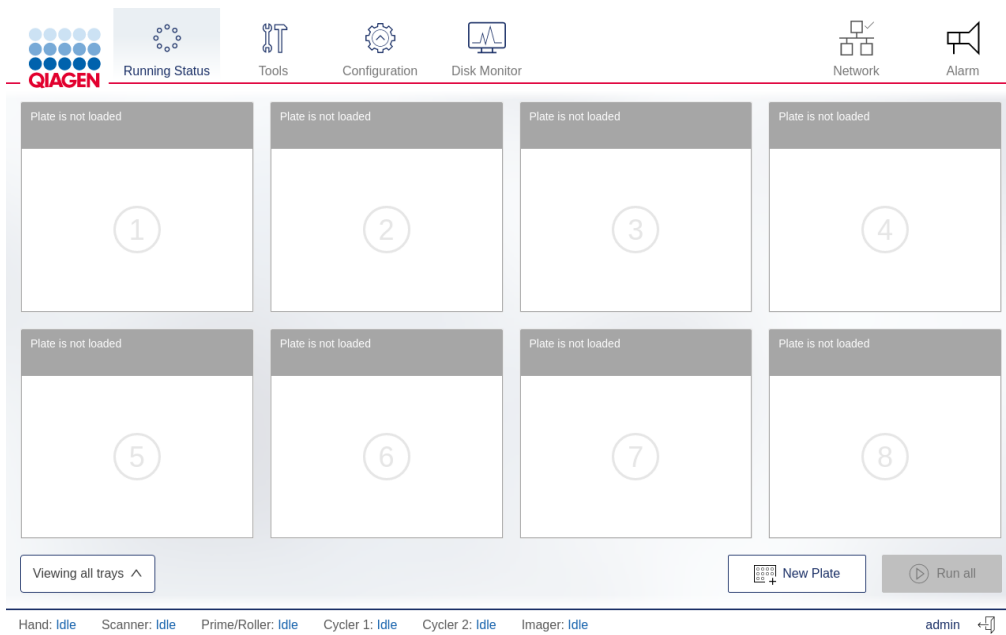

To load a tray and to start a run, follow these steps:

1. To eject a tray, press the physical button on the instrument or tap **Eject Tray** on the touchscreen.

Note: In QIAcuity Eight, you can select to eject either the upper or lower tray from the list located below the panes.

2. Place a plate in one of the slots of the ejected tray. Ensure that the plate is placed in the correct orientation, facing the barcode toward the instrument and the QIAGEN lettering toward you. Also, ensure that the plate seal of the plate is intact and not overlapping any of the sides more than 1 mm. Repeat this step until all plates are loaded to the tray.

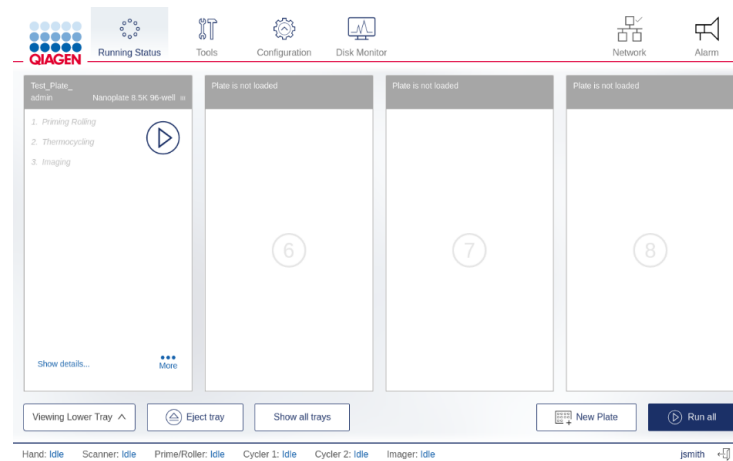

3. Tap **Close Tray** or press the physical button on the instrument to close the tray. Do not push the tray itself.
4. The instrument scans the barcodes on the plates. The instrument detects the availability of the plate and the label of the corresponding pane changes to **Plate is detected**. If the barcode matches to an existing experiment in the Software Suite, the loaded plate pane displays the defined run setup and can be started.

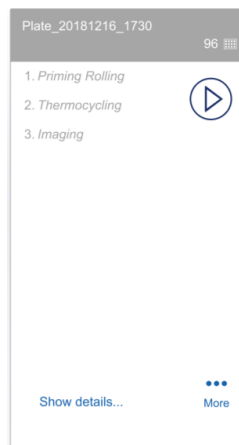

Note: In case the barcode does not match an existing plate in the Software Suite (e.g., if no barcode has been defined in the experiment setup), the plate can be assigned manually from the list of pre-defined plates without barcodes.

Note: If the plate is expired, a warning message displays, indicating the expiration date. User may continue with this plate at your own risk.

5. To view the details of the plate, tap **Show details** in the corresponding plate's pane.

6. When all plates are correctly labelled and the corresponding data are received from the QIAcuity Software Suite, start the run.
 - To start the run on all plates simultaneously without making any changes, tap **Run all**.
 - To start the run of an individual plate without making any changes, tap the **Run**  icon on the plate's pane.
 - To edit the parameters of a plate before starting a run, follow the steps described in section "Configuring a plate and starting a run".

Note: A run can only be started if the current user logged in has the appropriate rights.

Note: After a plate is loaded into the instrument, the QIAcuity sends a request to the Software Suite to lock the plate. This ensures that the plate is not modified by another user in the Software Suite while the plate is loaded and operated by an instrument. The plate is unlocked after it is unloaded from the instrument.

6.4.2. Configuring a plate and starting a run

User can configure a plate before (in Software Suite) or after it has been loaded to the instrument.

Note: For configured plates and loaded into instrument, only dPCR parameters can be changed; General Data cannot be edited. Changes are not allowed during the run.

To start the configuration of a plate that has been loaded into the instrument, follow these steps:

1. On the plate's pane, tap **More**.

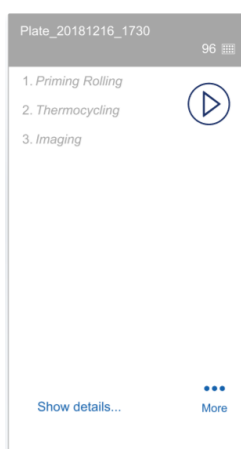

2. Tap **Edit plate** or **Create a new plate** to proceed to the plate configurator.

Note: The **Edit plate** button becomes available when a plate is loaded and the instrument successfully received the data from the Software Suite. The **Create a new plate** button is available when the plate's barcode is not found in the Software Suite database or when the QIAcuity cannot connect to the Software Suite.

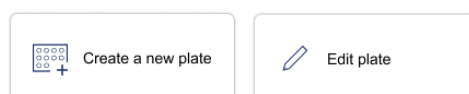

3. Proceed to "Plate configuration procedure".

To start the configuration of a plate that has not been loaded into the instrument, follow these steps:

1. On the Home (Running status) screen, tap **New Plate**.

Note: The **New Plate** button is not available for single-plate instruments.

2. To input the barcode manually, tap the "Barcode" field. To scan the barcode using the external USB scanner, tap **Scan**.
3. Proceed to "Plate configuration procedure" section.

6.4.3. Plate configuration procedure

To configure a plate and start the run, follow these steps:

1. In the General data step, enter the following information:
 - **Plate Name:** Enter the name of the plate.
Note: The plate type is automatically selected based on the scanned barcode.
 - **Description (optional):** Provide a description for the plate.

Note: If you are editing an existing plate, you can only change the values in the **dPCR Parameters** section. The fields in the **General Data** section are disabled.

NEW PLATE CONFIGURATOR
Plate 123

General Data | dPCR Parameter

Plate Name: Plate 123 (Characters left: 91)

Plate Type: 96 Wells (12x8)

Description (optional): (Characters left: 200)

Barcode: AABB_96

Recommended next step: dPCR parameters

Back to Running Status overview | Save | Done

Note: If you are creating a plate, you are automatically assigned as an owner of a plate. Owners are displayed under plate name on running status page. Modifying owners of the plate is only possible by editing the plate in the Software Suite.

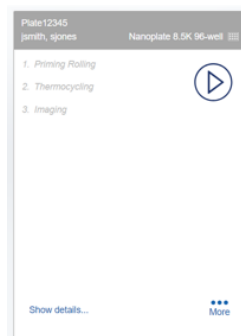

2. Tap **dPCR parameters** to proceed with the next step.

Note: Each step in dPCR parameters has its own tab. The **Priming**, **Cycling**, and **Imaging** tabs are mandatory.

3. In the **Priming** tab, select the applicable priming profile. Starting with QIAcuity software version 3.0:

- To improve overall filling of all Nanoplate types: two priming profiles are available for selection for probe based and EvaGreen based (RT-) reaction mixes.

Important: Nanoplates for those profiles must be sealed with the Nanoplate Seals.

- To omit filling in the Priming process for all Nanoplate types: one priming profile is dedicated to the plates sealed in an Automatic Plate Sealer called “No Priming” – available after pressing **More**.

Important: Nanoplates sealed with the automatic plate sealing solution are already filled during that process.

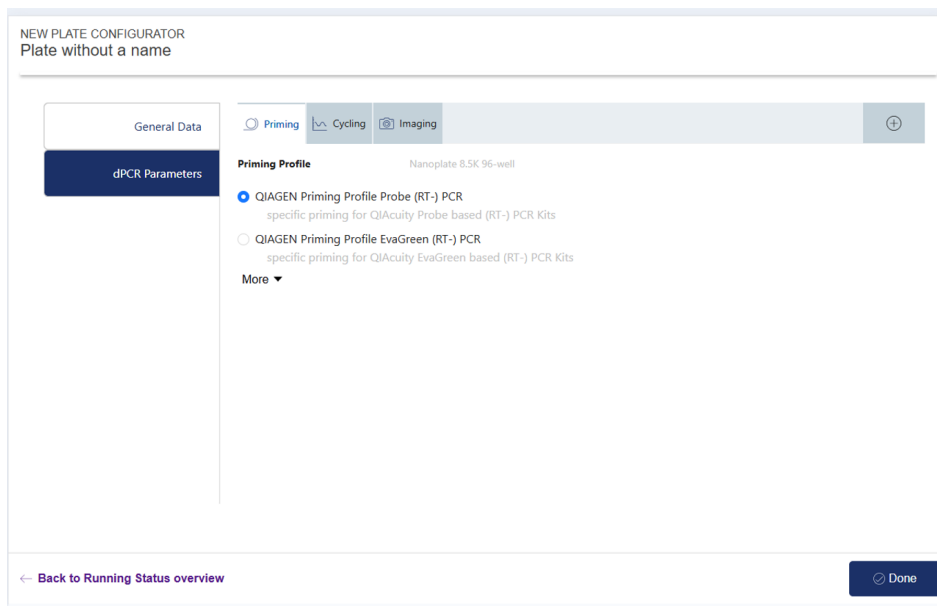

4. Perform the following steps in the **Cycling** tab:

- a. Enter your desired temperature in the “Temperature” field.
- b. In the “Duration” field, enter the cycling duration for the plate.
- c. Tap **Add temperature step**.

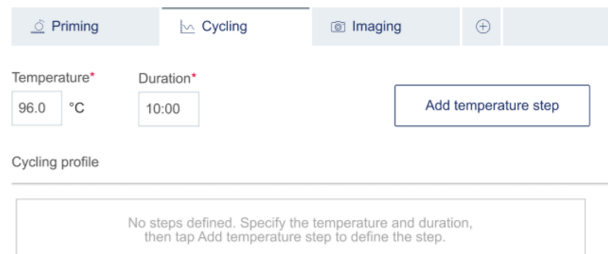

Note: The gradient cycling option can only be defined in the Software Suite.

5. If you want to modify the temperature steps, refer to these steps:
 - To edit or delete a temperature step, tap the **More ...** icon, then tap **Edit** or **Delete**.

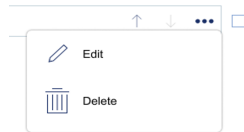

- To group the temperature steps, check the corresponding boxes of more than one temperature step, then tap **Group**.
- To ungroup a group of temperature steps, tap the **More ...** icon, then tap **Ungroup**.

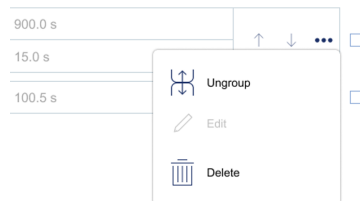

6. Perform the following steps in the **Imaging** tab:

- a. In the **Imaging** tab, select the applicable channel, then enter the exposure duration and gain in the “Exposure duration” and “Gain” fields.
- b. On all QIAcuity instruments (excluding QIAcuity One, 2 plex), high multiplex experiments, up to 8-plex analysis, can be performed. Channels 6–8 (Far Red and the combinations of Green/Yellow, Yellow/Orange, Orange/Red, Red/Crimson, Crimson/Far Red) require the High-Multiplexing-Reference channel of the new QIAcuity High Multiplex Kit. If any of the above channels is selected on the **Imaging** tab, the system will automatically enable the required High-Multiplexing Reference channel and the user cannot disable it. It is also possible to activate the High-Multiplexing-Reference channel for standard channel usage.
- c. To include more steps in the run, tap the **Add**  icon, then select the applicable step. Provide the required information for the step. Repeat this step if more steps are needed for the run. In total, 9 steps can be performed per plate.
- d. Tap **Save** to save your progress or tap **Done** to save the run and go back to the Running Status window.

Note: If any required field is not completed, an error message displays, pointing out the missing information required in each field.

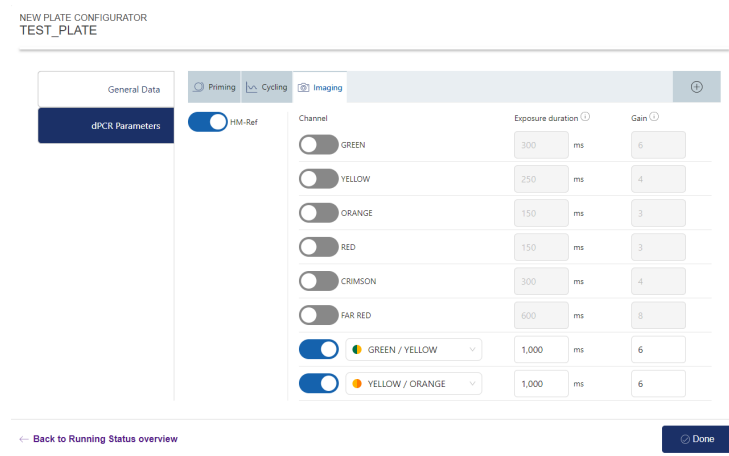

7. Start the run in the Running Status window:

- To start the run on all plates simultaneously without making any changes, tap **Run all**.
- To start the run of an individual plate without making any changes, tap the corresponding **Run**  icon located on the plate's pane.

6.4.4. Linking a plate to a pre-defined plate without existing barcode

If the instrument cannot match the barcode on a loaded plate to a barcode that already exists in the Software Suite, the plate can be linked manually. Alternatively, a new plate can be created by following the steps in section "Configuring a plate and starting a run".

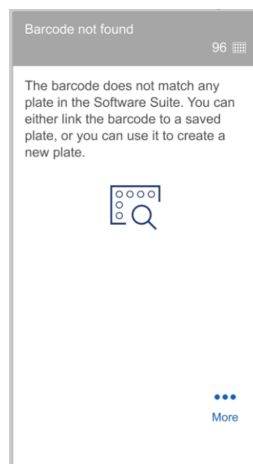

To link the barcode to a defined plate in the Software Suite that has no barcode defined, follow these steps:

1. Tap the **Link**  icon.
2. In the Select Plate dialog box, select the plate that you want to link to the barcode of the loaded plate.

Note: Only plates with a “Defined” status without a barcode assigned can be linked.

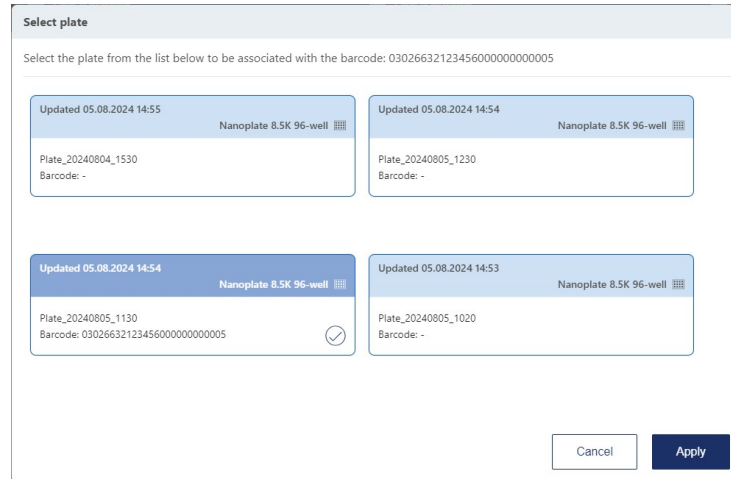

3. Tap **Apply**.

6.5. Tracking the run status

Once the run has started, the status of the run can be tracked. The plate that the QIAcuity is currently working with is distinguishable through the following elements:

- The Running status is displayed in the pane.
- The **Stop Run**  button is available.
- A status bar with the remaining time is displayed.

The panel also shows all the steps within the run. The font color of the steps that are completed is black. When a step is in progress, its font color is blue. Pending steps are shown in light gray.

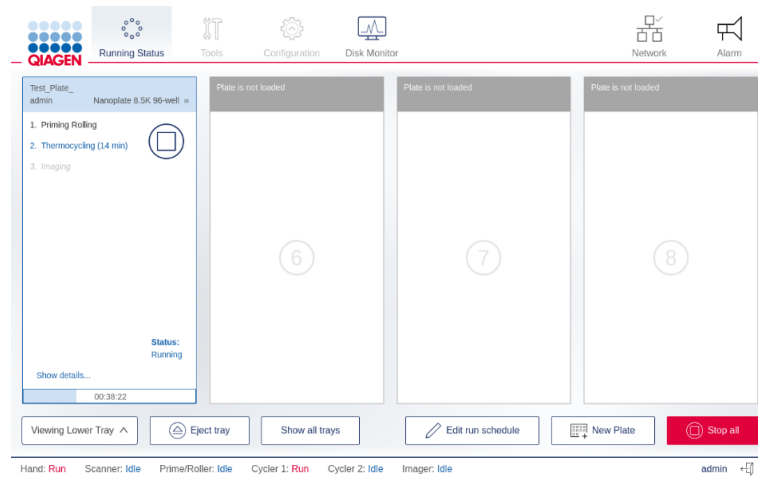

To view more details about the run, tap **Show details**. The dialog box appears containing information about the plate (in the **General Data** tab), as well as each step of the run (in the **dPCR Parameters** tab).

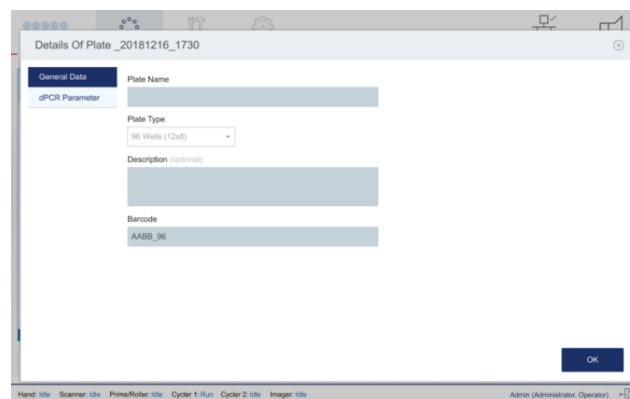

To view information about the individual steps of the run, tap **dPCR Parameters**, then tap the step that contains the details you want to view. The instrument shows the status of each step of the run, and the remaining time of the current step. You can also view the parameters defined for each step.

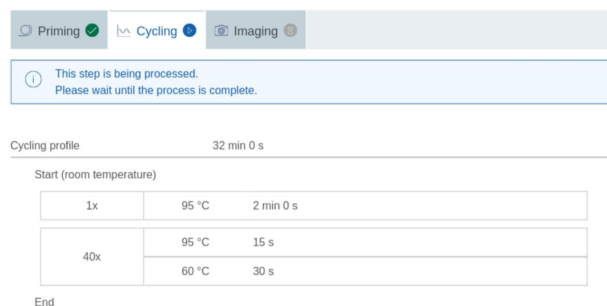





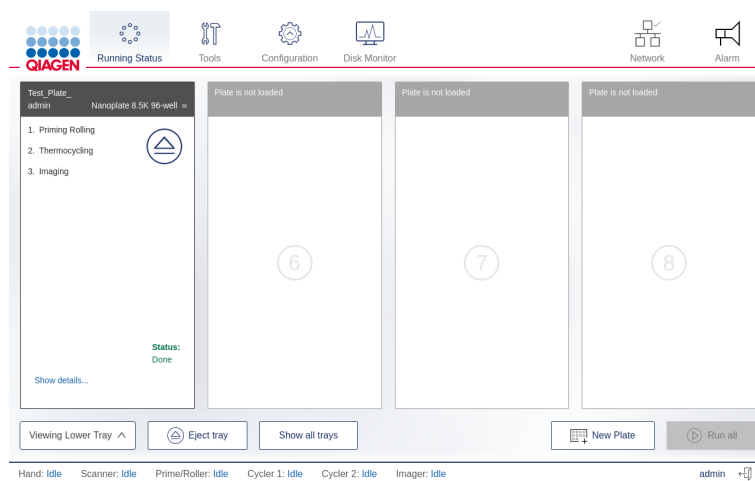

Table 7 shows the meaning of each status icon that is shown in the dPCR parameters step.

Table 7. dPCR step status icon

Icon	Status
	The step is successfully finished.
	The step is being executed.
	The step is pending, and its execution will start after the current step is done.
	The step failed.

When the run is finished, the status of the run changes to **Done** and the **Eject**  button becomes available. To view the details about the run, tap **Show details**. To eject the plate, tap **Eject**  button.



6.6. Continuous loading and unloading of plates



Note: The **Continuous loading and unloading of plates** function is only available with QIAcuity Eight and QIAcuity Four instruments. To unload a plate that is currently running in the QIAcuity One instrument, you need to abort the run. For more information, see section “Aborting a run”.

On multi-plate instruments, user can load and unload plates while the instrument is running. User can load new plates, unload finished ones, or remove plates that are still in progress. To eject a tray, press the physical button on the instrument or tap **Eject tray** on the touchscreen. If any of the running plates are in the Imaging step, this process is paused. Once the changes in the tray are done, tap **Close tray** or press the physical button on the device to close the tray. The software checks the plates and displays the plate information on the screen. If any of the plates that were running before the tray was opened are missing, an error message appears, and the run is stopped.

Note: If the slot where the new plate is placed is also used by a plate that is in a different module, an error message is shown on the screen and the new plate must be moved to a free slot. The drawer opens automatically, which can take up to two minutes. Move the plate and close the drawer to proceed.

Note: Depending on the time frame for unloading/loading of plates, the drawer opening might be delayed some time to finalize current movement steps.

6.7. Aborting a run

- If needed, a run can be stopped at any time. User can either abort all running plates or only a single running plate. To abort all runs on all plates, tap **Stop all**. Tap **OK** in the confirmation dialog box to proceed.
- To abort a single plate, tap the **Stop Run**  icon on its pane. All aborted plates return to their loading position on the tray.
- To unload the plates from the instrument, tap the **Eject**  button.

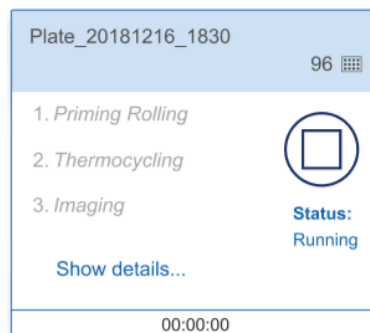

Aborting a plate during the priming/rolling step renders it unusable and the plate cannot be used and run again. A plate that has been aborted during the Thermocycling or Imaging step can be used again. To rerun the plate, configure a run with only the remaining steps. See section “Rerunning a plate” for more information.

Note: A run cannot be stopped during barcode scanning or when one or more trays are ejected.

Note: If the **Eject**  button is tapped or the physical eject button on the instrument is pressed before the plate is returned to the tray, a warning message is displayed on the screen, and the tray is ejected after the plate is transported to drawer.

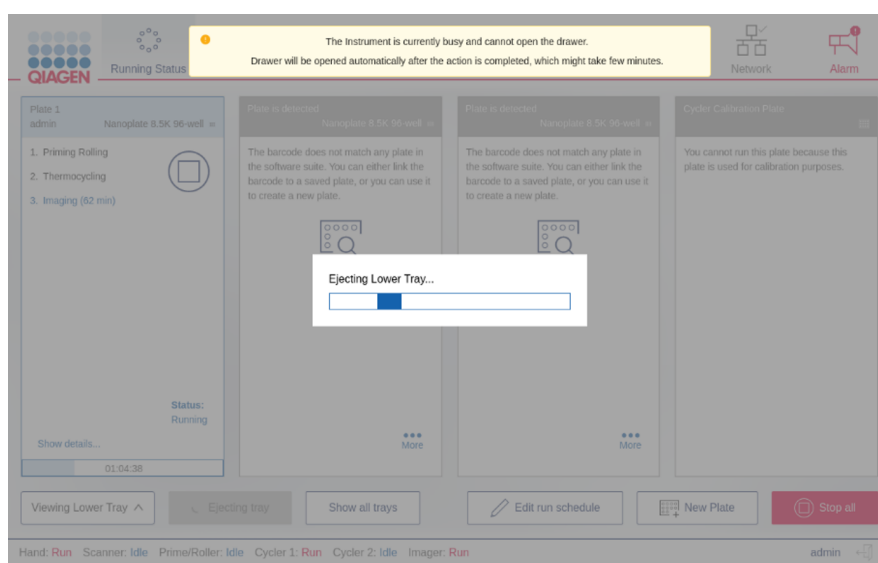

6.8. Error clearing

The Control Software provides an error-handling functionality to ensure that the software is in a defined state. It is designed to provide a streamlined and efficient way to manage potential system faults.

If an error appears on a specific module during the run, a notification will display under the “Alarm” notification box, for logged-in users with appropriate permissions.

If the instrument was restarted after the error appeared during the run, a gray screen will display the list of errors that appeared and a **Clear errors** button to provide manual clearing of the errors without a need for instrument restart.

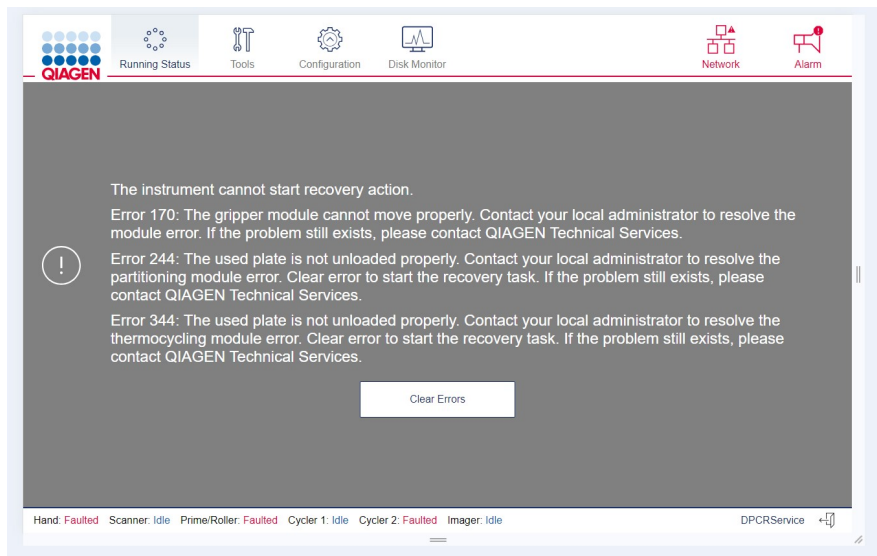

For a separate way to clear module-related errors, go to the **Tools > System status** panel and press the **Clear errors** button.

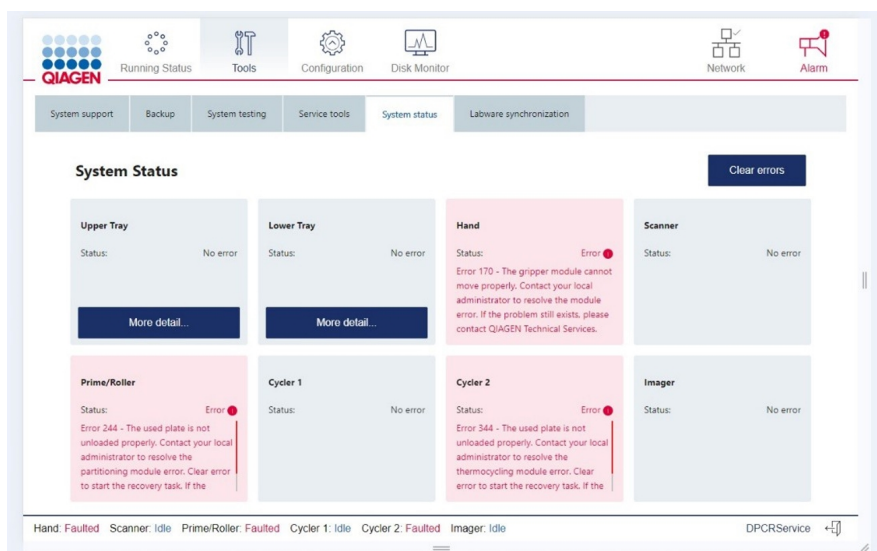

Confirmation is required after pressing the **Clear errors** button, as the process requires the affected modules to be reinitialized and the control software is blocked while this task occurs.

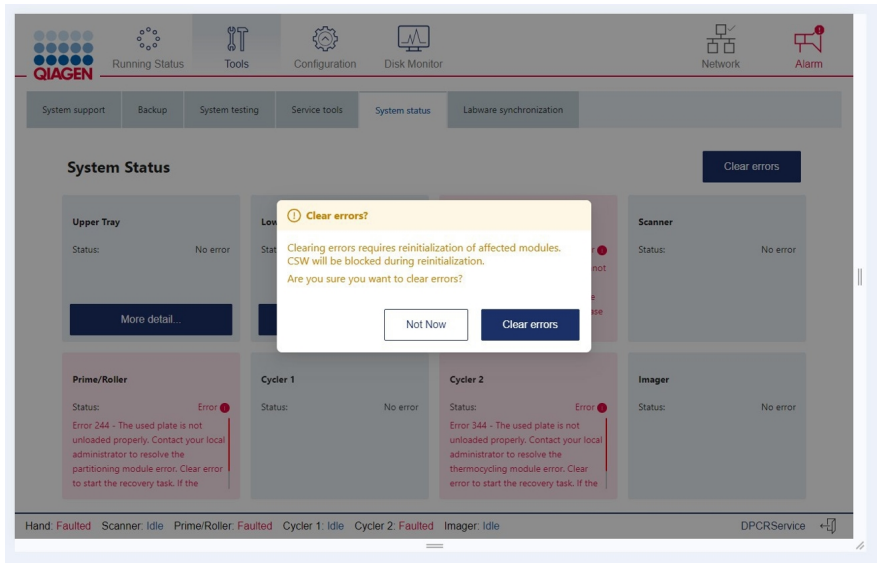

While the error clearing process occurs, information about the clearing status is displayed:

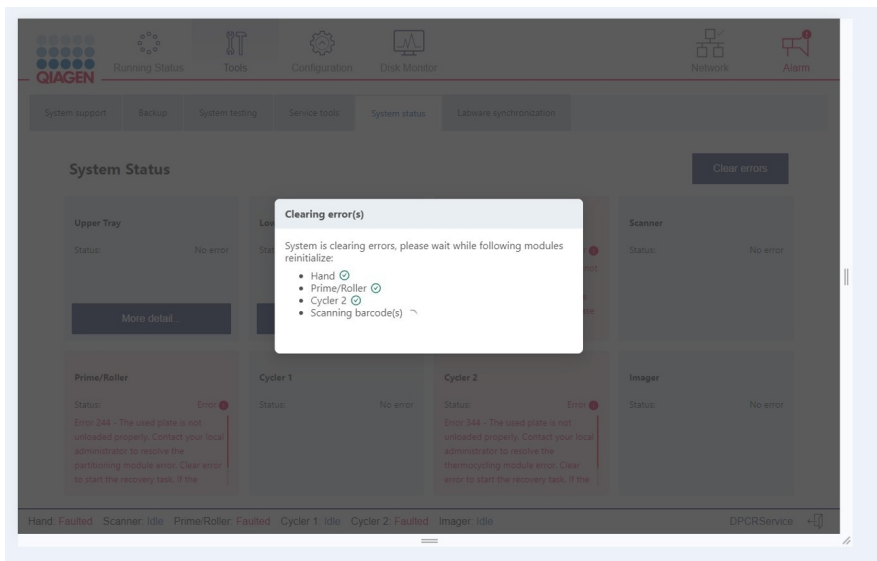

After the errors are cleared an information message appears at the top of the screen, informing the user that the errors have cleared successfully. The errors no longer appear on the **System status** tab and under the “Alarm” notification box.

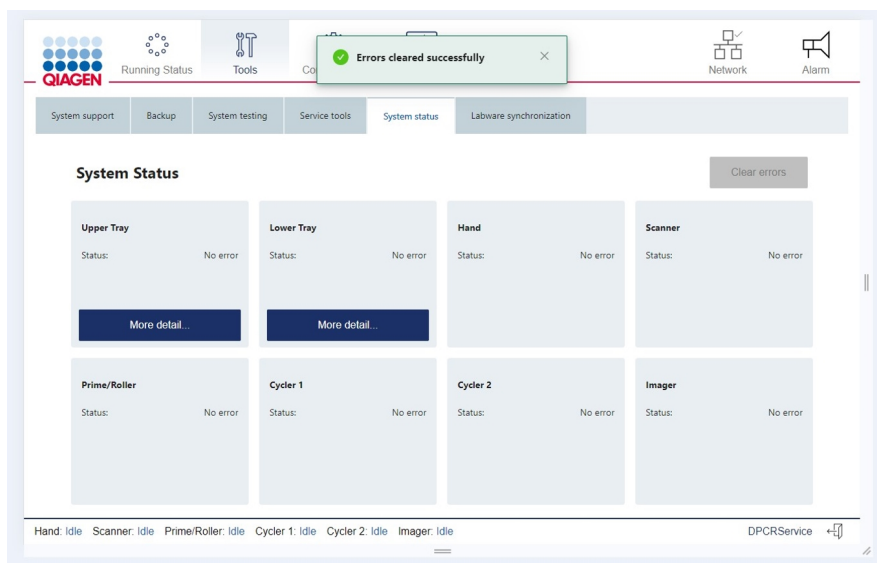

6.9. Automatic error clearing during the run

When Error 177 appears for the Hand, Primer, or Thermocycler module, it is currently thrown by the system and displayed on the “Alarm” notification page in the user interface (UI). Previously, this error stopped the run and the error must be manually cleared to resume operations. Rather than stopping the run immediately, the system will attempt automatic Hand positioning to retrieve the plate. Error will be eventually thrown and left for the user to be cleared after three unsuccessful attempts. This process reduces interruptions and enhances workflow continuity.

6.10. Rerunning a plate

If a plate failed or was aborted during the Thermocycling or Imaging step, it can be run again after adding new cycling or imaging steps. User can add the steps either through the instrument’s plate configurator or in the Software Suite. To add steps using the built-in plate configurator, follow the steps in the “Plate configuration procedure. To use the Software Suite, refer to section “Setting up an experiment”.

Note: To modify a plate that was already used, you must remove it from the instrument. This ensures that the plate is unlocked and ready for modifications in the QIAcuity Software Suite. If modifications are desired using the plate configurator on the instrument, load the Plate again.

6.1.1. Editing the run schedule

Note: Editing the run schedule is only possible on QIAcuity Eight and QIAcuity Four and for those users having the appropriate permissions (see Table 10).

When a run starts, it is added to the run schedule and the **Edit schedule** button is shown on the screen. If the runs are started individually, they will be added to the schedule in the order which they were started by tapping the **Run**  icon on their respective panes. If all the runs are started at the same time, using the **Run All** button, there is a default order in which the plates are run.

In QIAcuity Eight, the run starts with the first slot in the upper tray and ends with the last slot in the lower tray. The slot numbers are presented in Table 8.

Table 8. Slot numbers the QIAcuity Eight

Tray	Slot numbers			
Upper	1	2	3	4
Lower	5	6	7	8

In QIAcuity Four, the run starts with slot number 1 and ends with slot number 4. The slot numbers are presented in Table 9.

Table 9. Slot numbers of the QIAcuity Four

Slot numbers			
1	2	3	4

To edit the run schedule, follow these steps:

Note: Only runs that are not started yet (with Pending Run status) can be rearranged.

1. On the Running Status screen, tap **Edit run schedule**.

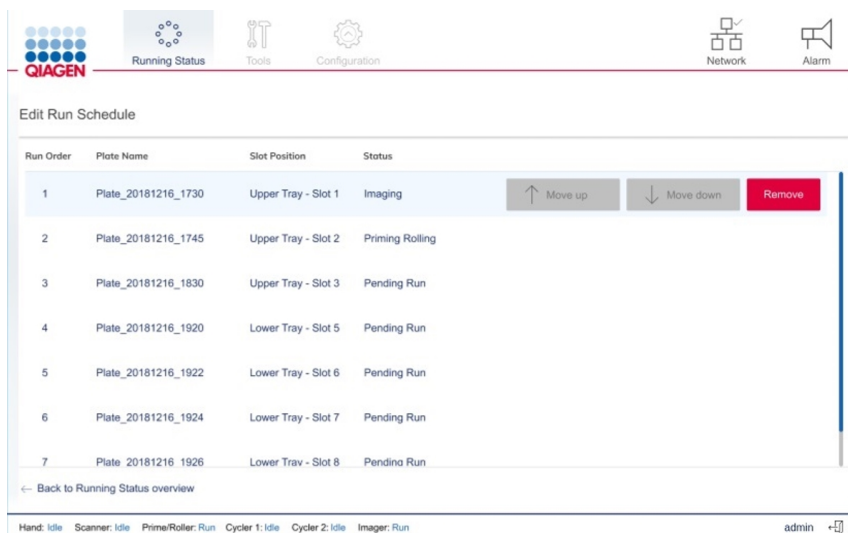

2. Tap the row corresponding to the plate to be moved.

3. Perform one of the following actions:

- Tap **Move up** to move the plate run to an earlier position.
- Tap **Move down** to move the plate run to a later position.
- Tap **Remove** to cancel the plate run. Tap **Back to running status overview** to go back to the Running status window.

6.12. Viewing notifications

If the QIAcuity detects an error that affects the workflow of the instrument that the user can resolve, a notification displays on the screen.

To view a list of all notifications and possible solutions to the errors, tap the **Alarm**  icon. The last three errors are shown. If there are more than three errors, tap **View all** to view the full list of errors.

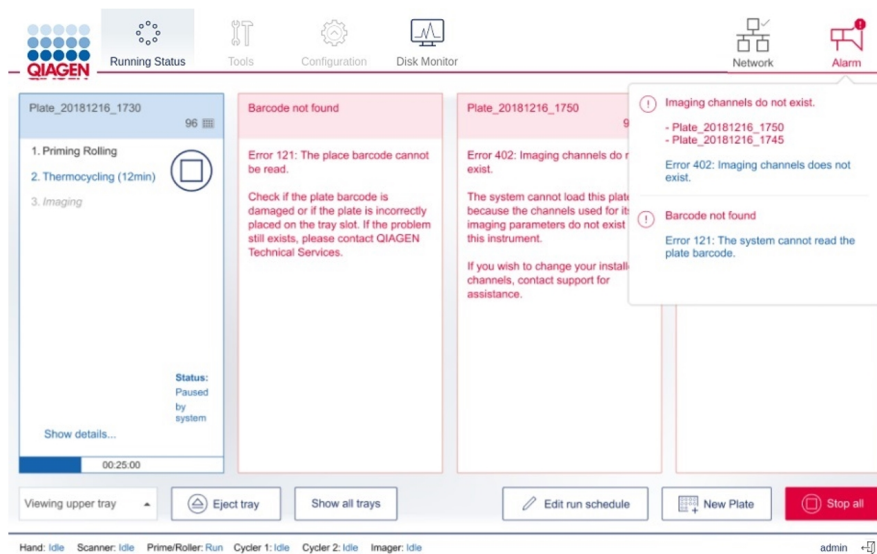

6.13. Disk monitoring

The **Disk Monitor** icon located in the header shows the real-time usage of the disk (free space and usage percentage). Depending on the space left, the information is shown in different colors. The **Disk Monitor** icon can appear as follows:

- **Blue** – When the disk occupation percentage is below 75% of the entire disk space

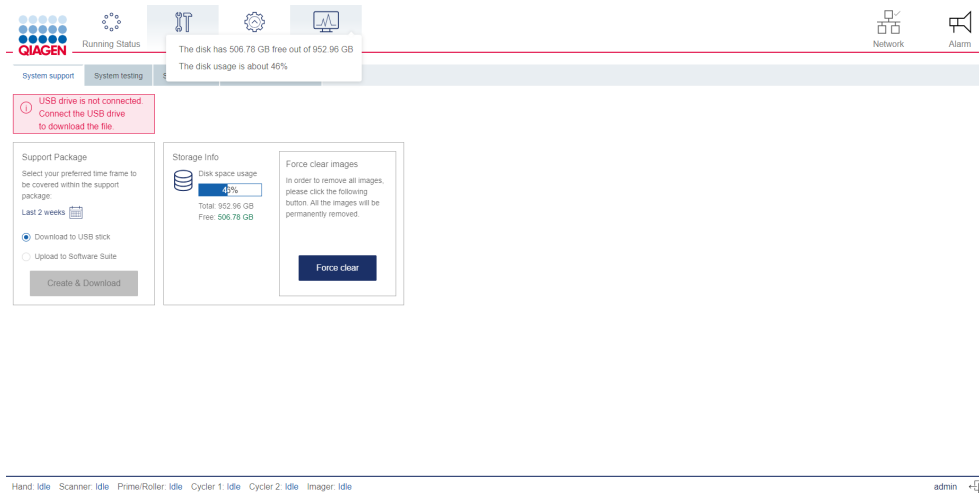

- **Yellow** – When the usage of the disk occupation rises above 75%

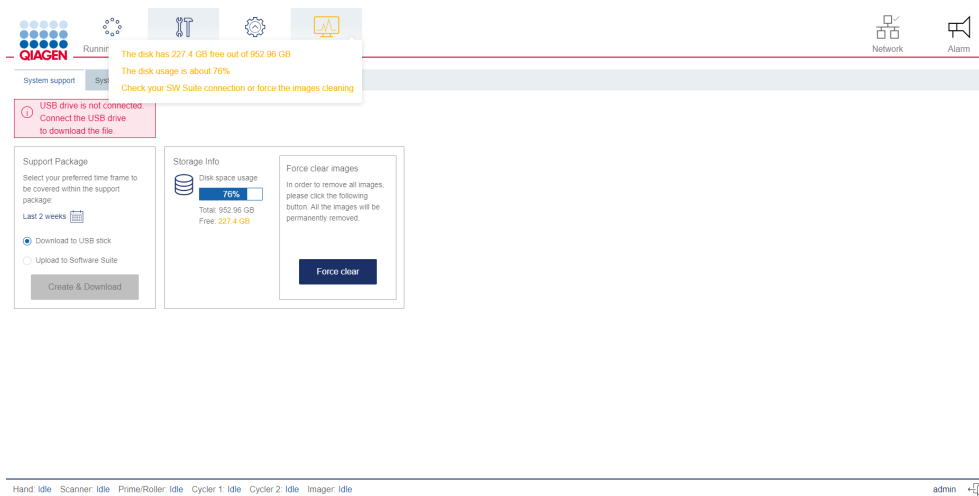

- **Red** – when the remaining free disk space is less than 4 GB (approx. 14%)

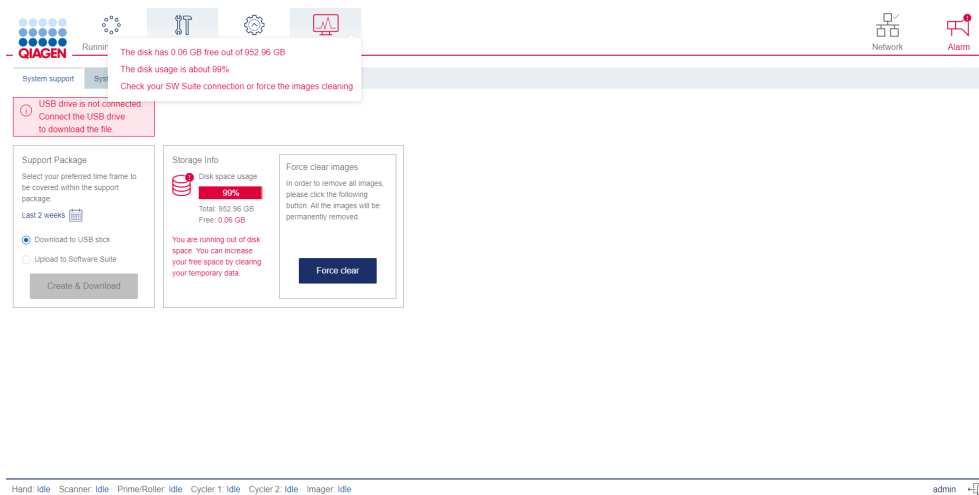

In case of Yellow and Red scenarios, additional information is shown to inform user about the actions that should be taken to regain disk space: forcing the clearing of images which have not been transferred to the Software Suite or setting up a connection with the Software Suite.

6.14. Logging out

Note: If a run is processing, you can still access its status, even if you log out of the instrument. For more information, refer to “Automatic logout” section.

To log out of the instrument, follow these steps:

1. Tap the **Logout** icon located at the bottom right of the touchscreen.

Note: The **Logout** button is disabled when the instrument is being calibrated or when a tray is ejected. However, you can log out when a plate is running.

2. In the Confirmation dialog box, tap **OK** to confirm or tap **Cancel** to go back.

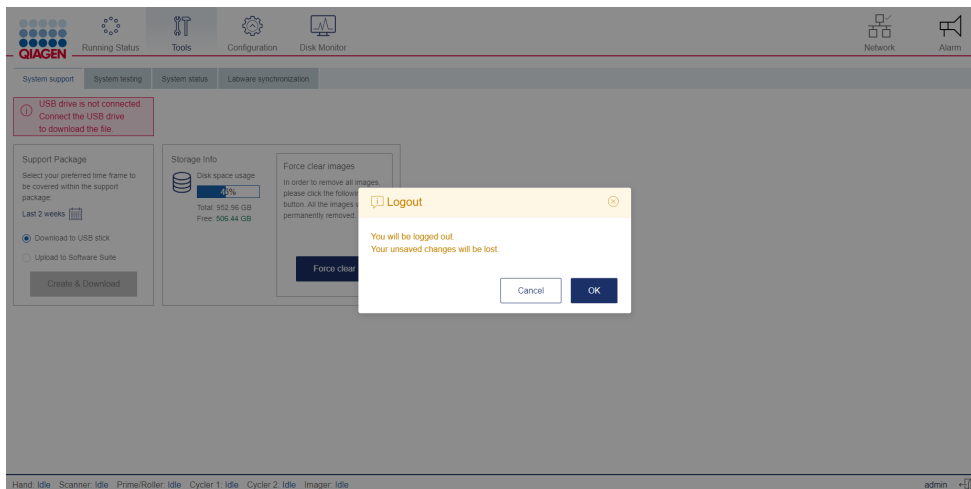

6.14.1. Automatic logout

Users are automatically logged off after a default setting of a 15 minute period of inactivity. Time delay between user inactivity and log off can be configured manually or disabled under **Configuration > Automatic log off**. The maximum value that can be applied is 7 hours 59 minutes.

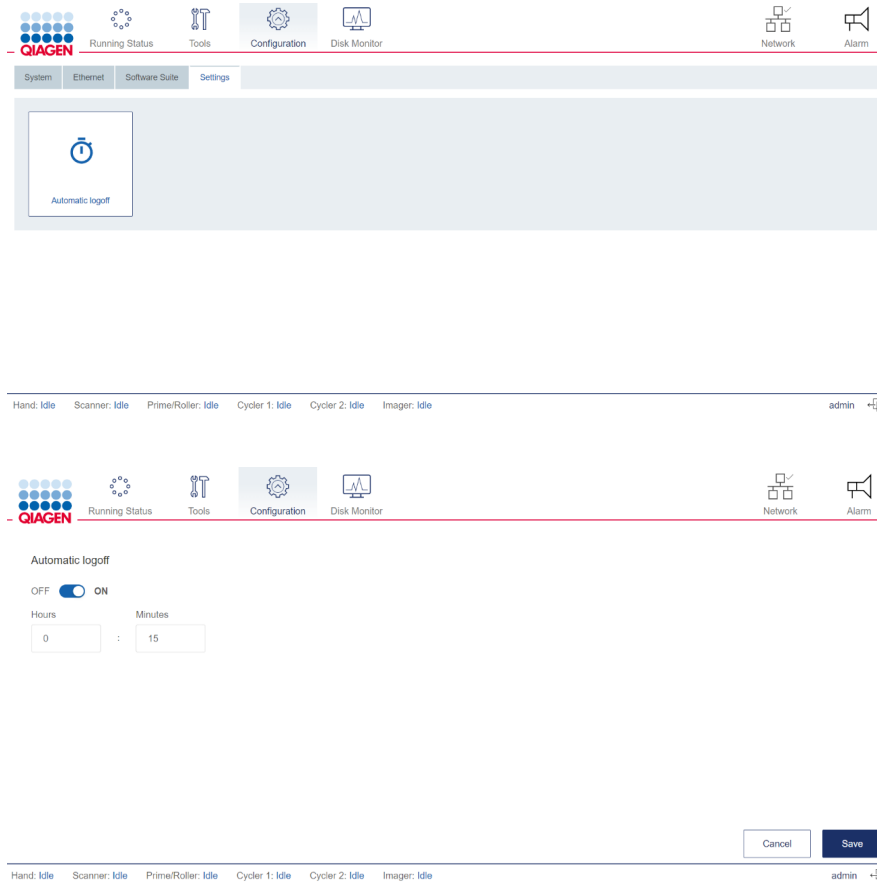

Note: For unsaved data, for example, during plate creation, an automatic log out will lead to loss of entries.

6.14.2. Accessing the run status when you are logged out

After logging out, the Login screen is displayed on the QIAcuity display. To view the run status of an ongoing run, tap **Running status**. The Running status screen is displayed in view-only mode. All functions are disabled. To perform any actions related to the run and the plates that are being processed, log into the instrument.

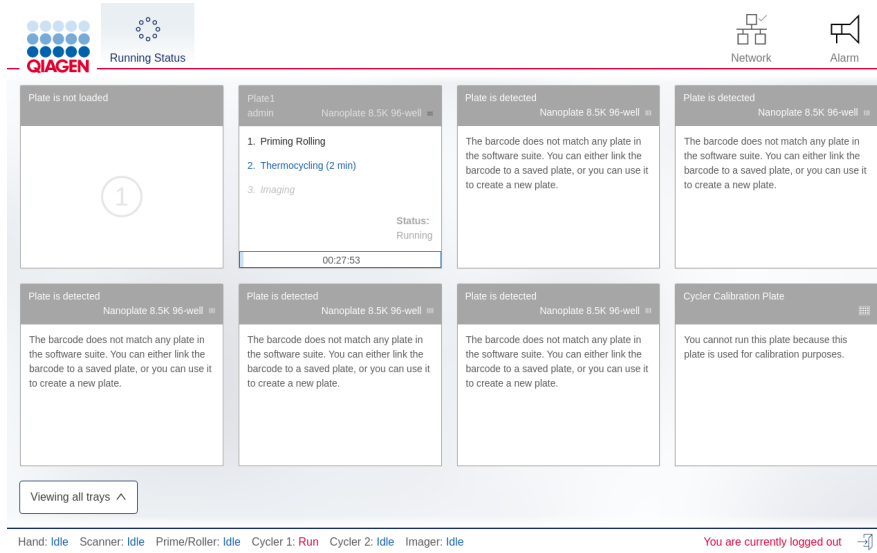

7. Operating the QIAcuity Software Suite

7.1. Getting started

This section describes the workspace within the QIAcuity Software Suite, its basic concepts, and the general software use.

Note: If the network connection was set up, the Software Suite can be accessed via another laptop using the IP address of the Software Suite server. Up to 10 users can access the system in parallel.

7.1.1. Software workspace

Main toolbar

The main toolbar shows navigation items. Clicking the icon navigates to the overview of the selected area. Depending on your role, not all navigation areas might be visible. An active icon becomes highlighted.



Environment area contains the **Plates**, **Templates**, **Disk monitor**, and **Archive** icons. **Tools**, **Configuration**, and **Login settings** are in the Configuration area.

Navigation areas



A plate describes each experiment and contains all information regarding the experiment such as run setup, plate layout, and analysis results. See section "Setting up an experiment" and section "Managing your plates" for more information.



To perform an experiment multiple times, user can create templates to enable a faster setup of plates. See section "Setting up an experiment" and section "Creating a new reaction mix template" for more information.



To operate the QIAcuity Software Suite, free disk space is needed. See "Regular maintenance procedure of QIAcuity" for more information.



To archive plates on an external drive, user can configure the archive. See section "Archive" for more information.



Tools

The **Tools** tab contains the Troubleshooting sub-page that allows user to generate a password-protected software support package described in section “Problem during the Software Suite runtime”.



Configuration

In the **Configuration** tab, user can access configuration features such as Instrument name, Archive Management, User Management, and Audit Trail. Only Administrator, Supervisor, Quality Assurance, and Lab leader roles have access to this panel. See “Operating the QIAcuity Software Suite”.



admin ▾

The logged-in user is shown in the main toolbar. For more information, see “Concepts of the QIAcuity Software Suite”.

Information bar

The information bar located at the bottom of the screen displays the software version.



When the user’s mouse hovers over the **i** icon, additional information is presented: unique Software Suite ID and build version.

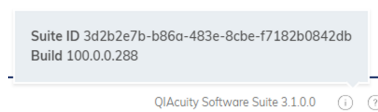

7.2. Concepts of the QIAcuity Software Suite

7.2.1. Log-in screen

The main toolbar shows which user is currently logged in. To view more information about the user, click the icon. The user can change the password, edit the user profile, and log out.

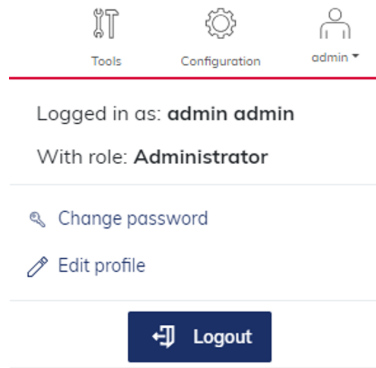

Note: Log-in on QIAcuity Software Suite is independent from log-in on the instrument.

1. To change the password, click **Change password**. The Change user password dialog box appears.

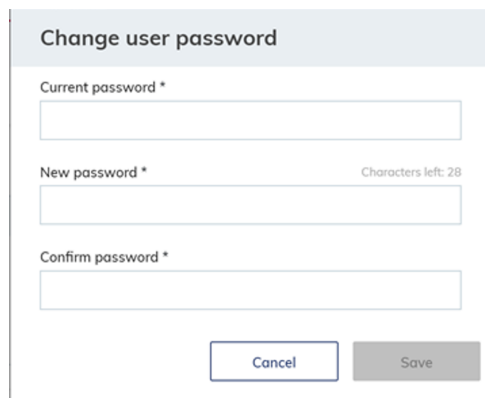
A screenshot of the 'Change user password' dialog box. The title bar reads 'Change user password'. There are three input fields: 'Current password *', 'New password *', and 'Confirm password *'. The 'New password *' field has a character count indicator 'Characters left: 28'. At the bottom, there are two buttons: 'Cancel' and 'Save'.

2. Enter the current password in the "Current password" field and the new password in the "New password" field. In the "Confirm password" field, enter the same password specified in the "New password" field. Click **Save** to change the password.

3. To edit the user profile, click **Edit profile**. The Edit User profile dialog box appears.

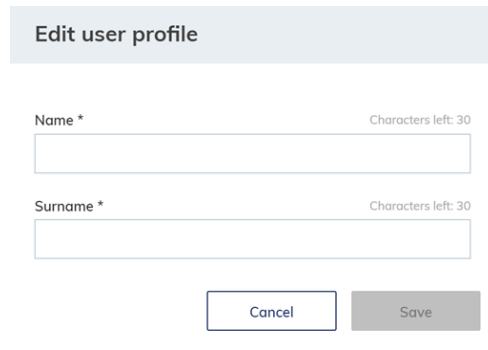

Edit user profile

Name * Characters left: 30

Surname * Characters left: 30

4. Enter a new name in the “Name” field and surname in the “Surname” field. Click **Save**.

5. To log out, click **Logout** to return to the home screen of the QIAcuity Software Suite.

7.2.2. User management

The QIAcuity Software Suite requires users to log in before accessing instrument functionalities. Each user must have a user account with an appropriate role assigned to it.

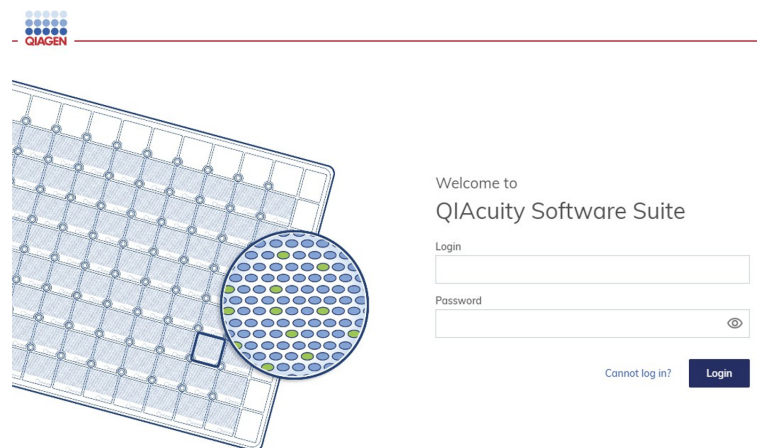

From QIAcuity Software Suite 2.0 and QIAcuity Control Software 2.0 onwards, the QIAcuity system offers an advanced user management that supports users meeting Good Manufacturing Practice (GMP)/Good Laboratory (GLP) regulations. The user management is centralized and controlled by the QIAcuity Software Suite only. In contrast to older software versions, users can no longer be created and edited by the instrument Control Software. All users, their roles, and their permissions are created and edited in the Software Suite and are automatically transferred to the instrument Control Software, facilitating unique and synchronized user management information. From version 2.1 onwards, users can either select predefined roles or create their own by selecting proper permission.

As a consequence, all users created with older versions than SW 2.0 will be overwritten by the Software Suite user management. After completing the update to Software Suite 2.2 and CSW 2.2, users might have to be created again in the Software Suite 2.2. All users created with SW 2.0 and user roles created with SW 2.1 are not affected and will remain after upgrade to Software Suite 2.2.

Important: For updates starting from Software Suite 2.0 and instrument Control Software 2.0, users will be migrated and forced to change their password during the first login attempt (except the initial administrator user with login name “admin” provided by QIAGEN during the initial installation). When working with Good Manufacturing Practice (GMP)/Good Laboratory (GLP) regulations, deactivate this initial admin user (for which the password does not expire) once at least one additional user with administrator rights has been created.

The advanced User Management allows one to create, edit, activate, and deactivate the user and provide a unique login and one password for both the instrument and the Software Suite (PC). Login is entered only once and cannot be changed. In addition, each user is assigned to a specific user role (see “Default Roles” section).

A user role is a set of permissions to features relating to the instrument or the Software Suite (PC). Each user is assigned to one role only.

The centralized user management enables independent use of instrument Control Software and Software Suite. Regardless of which user is logged in with which role on the Software Suite, another user can log in with a different role on the instrument. Both log-ins are completely independent from each other.

7.2.3. Navigating in the User Management panel

1. Click the **Configuration** tab on the top bar menu.



2. Choose and click the **User Management** tab on the left-hand side menu, then select **Users view**.

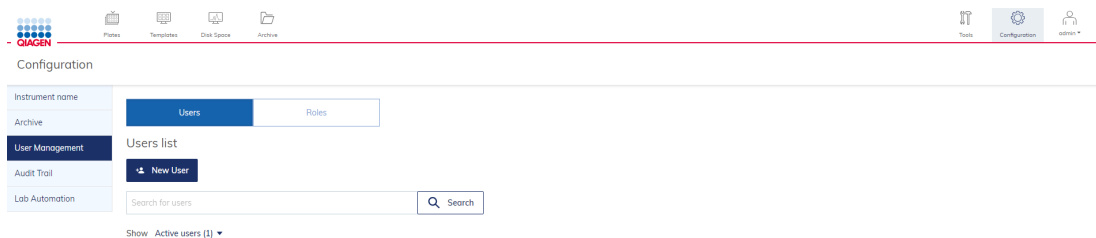

7.2.4. New user creation

All activities related to creating/editing/deactivating users can be found within the **User Management** tab in the Users view.

Note: To read **Users list**, the permission to “Read users and roles” is required. To create or edit users, additionally the permission “Create and Edit Users and Roles” is required.

1. If you want to create a new user, click the **New User** button.



- Fill out the form: user name (first name), surname, login, and password.

Note: There is an already existing login “System” that is reserved for special users. It cannot be selected by the Administrator when the new user is created. A warning message is shown when the Administrator tries to create a user with a reserved login.

The screenshot shows the 'NEW USER CREATION' interface for a user named 'John Doe'. The interface is divided into two steps: '1 User information' and '2 Permissions'. The 'User information' step is active, and the form contains the following fields:

- Name *: John
- Surname *: Doe
- Login *: johnd
- Password *: [masked]

The 'Next' button is located at the bottom right of the form area. A 'Back to Users List' link is visible at the bottom left.

Remember that user can enter any particular user login name only once, and after user creation, it cannot be changed or used again. To create a unique login, use letters, numbers, and symbols. The minimum number of characters for the user login is 5.

- When all information is filled out properly, click **Next** or **Permissions** to move to the next step.

The screenshot shows the 'NEW USER CREATION' interface for a user named 'John Doe'. The interface is divided into two steps: '1 User information' and '2 Permissions'. The 'User information' step is active, and the form contains the following fields:

- Name *: John
- Surname *: Doe
- Login *: jdoe123
- Password *: [masked]

The 'Next' button is located at the bottom right of the form area. A 'Back to Users List' link is visible at the bottom left.

4. In the Permissions (second) step, one role is chosen and assigned to the user. Description of all Roles can be found below. For detailed information about roles and permissions, refer to the table "Default role permissions" or the descriptions displayed on screen in the Software Suite during the user creation process.

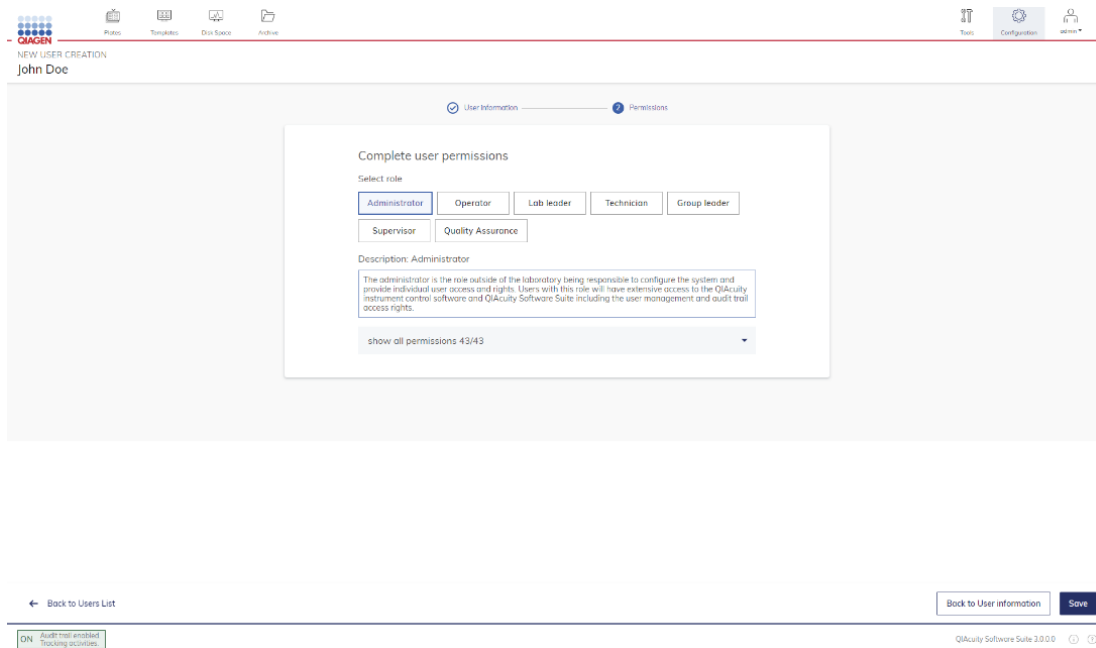

5. Click the selected role button. Read the description and choose the desired user role.

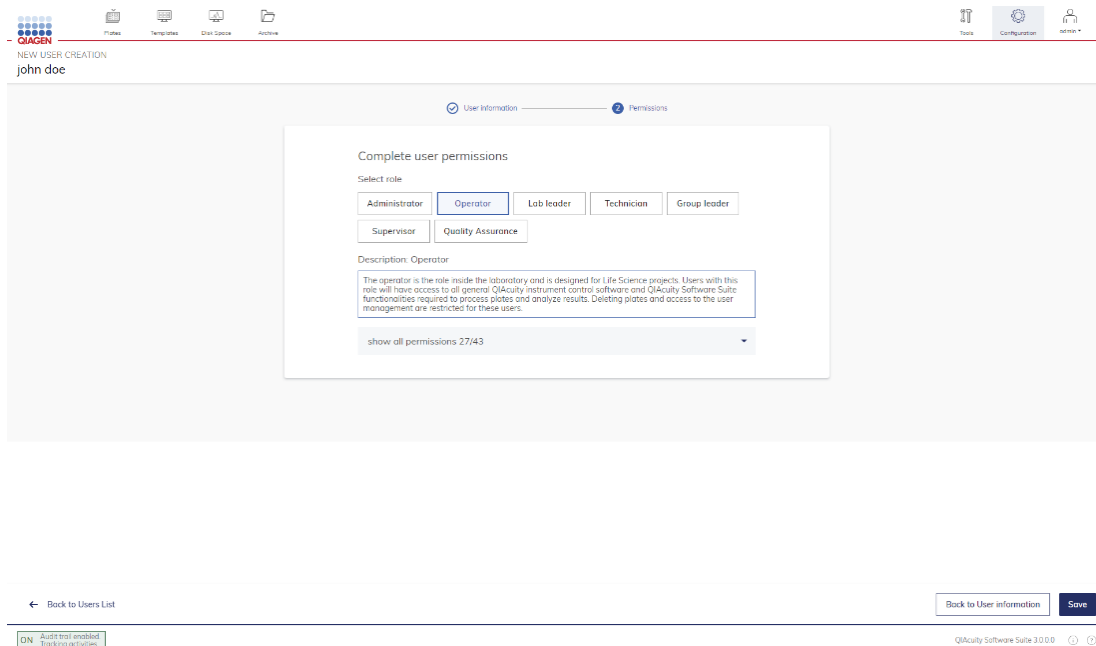

- Show/hide the permissions list assigned to each role by clicking the **show/hide all permissions** button below the role's description.

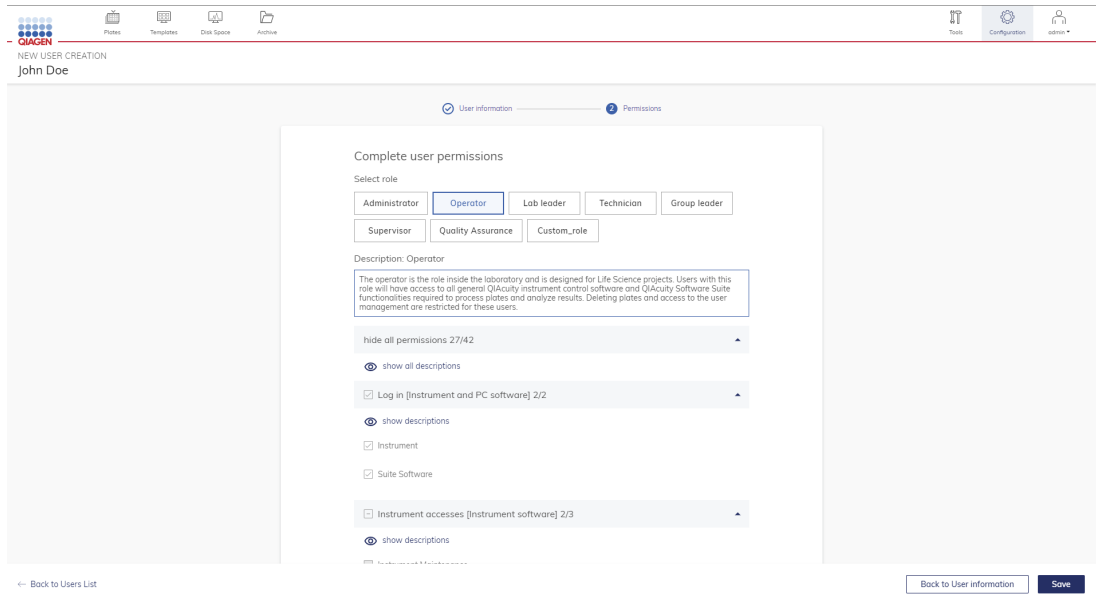

- Show/hide descriptions of the permissions related to particular permissions group or for all permissions at once by using the **show/hide all descriptions** button.

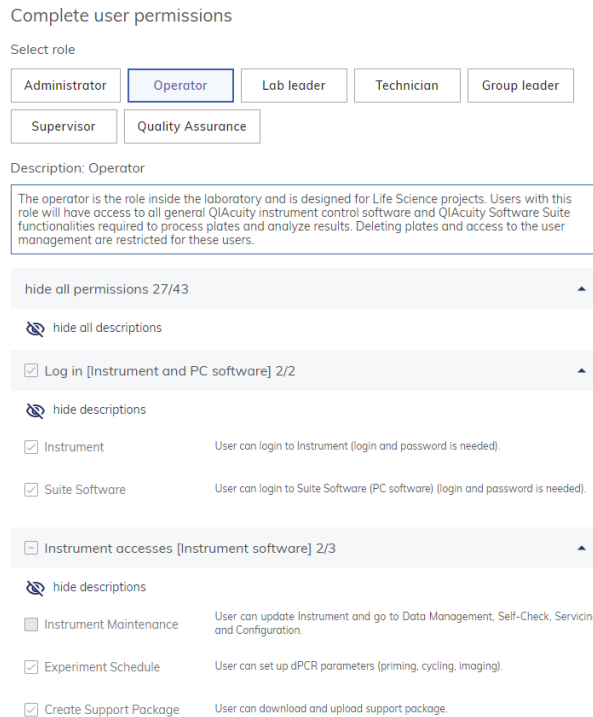

- To go back and check or change user information, click the **Back to User Information** button or the User information step in the navigation on the top of screen.

← Back to Users List

Back to User information

Save

- Click the **Save** button to confirm and create the user.

Save

It is possible to start with the user creation process from the Permissions step, but entries in the User information step are mandatory and will be highlighted by the software (see next screenshot).

- If Permissions are defined prior to User information, a yellow warning icon displays and the new user cannot be created until all mandatory information is entered.

Complete user permissions

Select role

Administrator Operator Lab leader Technician Group leader

Supervisor Quality Assurance

Description: Operator

The operator is the role inside the laboratory and is designed for Life Science projects. Users with this role will have access to all general QIAcuity instrument control software and QIAcuity Software Suite functionalities required to process plates and analyze results. Deleting plates and access to the user management are restricted for these users.

show all permissions 27/43

- Upon return to the User information section, all mandatory input fields will display in red and must be completed so that the new user can be created and information saved.

Complete user information

Name *

Required

Surname *

Required

Login *

Required

Password *

Required

3. If all inputs fields are filled out, click the **Next** button.

The screenshot shows the 'NEW USER CREATION' interface for 'John Doe'. The progress bar indicates the 'User information' step is active. The form contains the following fields:

- Name *: john
- Surname *: Doe
- Login *: jdoe123
- Password *: [masked]

Navigation buttons include 'Back to Users List' and 'Next'.

4. To create the user, click the **Save** button.

The screenshot shows the 'NEW USER CREATION' interface for 'John Doe'. The progress bar indicates the 'Permissions' step is active. The form contains the following elements:

- Select role: Administrator, Operator (selected), Lab leader, Technician, Group leader, Supervisor, Quality Assurance
- Description: Operator
- The operator is the role inside the laboratory and is designed for Life Science projects. Users with this role will have access to all general QIAcuity instrument control software and QIAcuity Software Suite functionalities required to process plates and analyze results. Deleting plates and access to the user management are restricted for these users.
- show all permissions 27/44

Navigation buttons include 'Back to Users List', 'Back to User Information', and 'Save'.

At any time during user creation it is possible to return to the Users List section by clicking the **Back to Users List** button, but all data entered will be lost.



7.2.5. Editing an existing user

To edit user data, follow the instructions below:

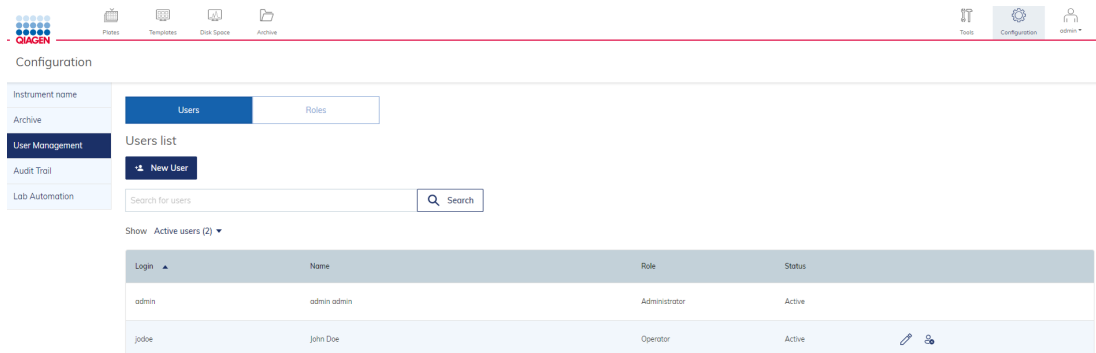
1. Find the desired user in the Users List.



The screenshot shows the QIAGEN configuration interface. The top navigation bar includes 'Plates', 'Templates', 'Disk Space', and 'Archive' on the left, and 'Tools', 'Configuration', and 'admin' on the right. The main content area is titled 'Configuration' and has a sidebar with 'Instrument name', 'Archive', 'User Management', 'Audit Trail', and 'Lab Automation'. The 'User Management' section is active, showing 'Users list' with a 'New User' button and a search bar. Below the search bar, there is a table of active users:

Login	Name	Role	Status	
admin	admin admin	Administrator	Active	
jdoe	John Doe	Operator	Active	 

2. Click the **edit user** icon.



3. At the left-hand side are three tabs related to editing user personal data and permissions.

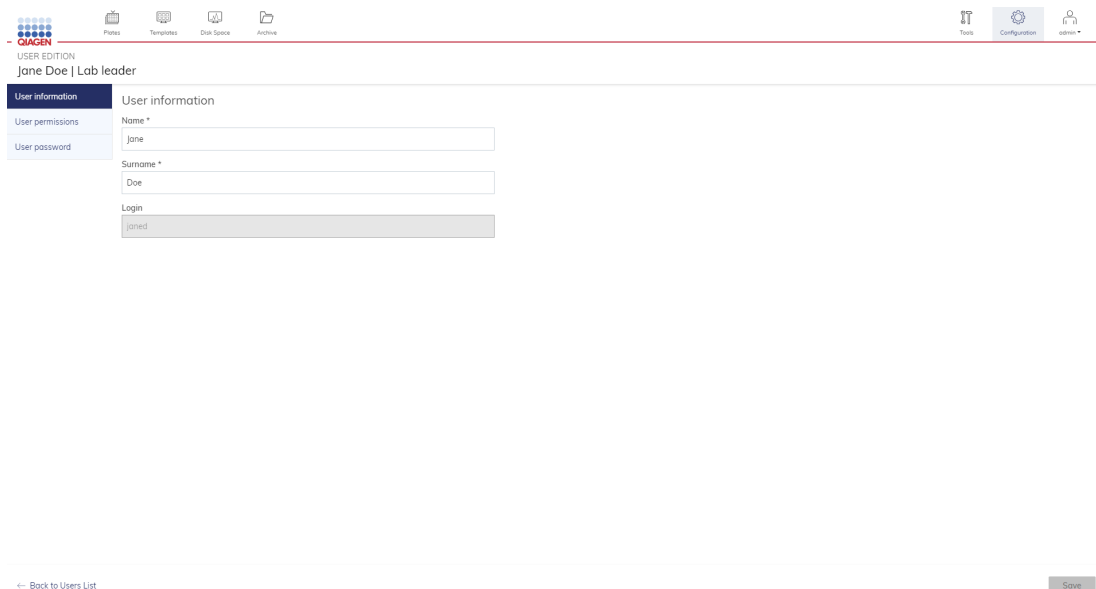

The screenshot shows the 'USER EDITION' interface for 'Jane Doe | Lab leader'. The top navigation bar is the same as in the previous screenshot. The main content area has a sidebar with 'User information', 'User permissions', and 'User password'. The 'User information' section is active, showing a form with the following fields:

- Name * (Jane)
- Surname * (Doe)
- Login (jdoe)

At the bottom left, there is a '← Back to Users List' link, and at the bottom right, there is a 'Save' button.

a. **User information** tab

Click the input field and type in the new name/surname. User login name cannot be changed.

The screenshot shows the 'User information' tab for a user named 'John Doe | Administrator'. The interface includes a top navigation bar with icons for 'Plates', 'Templates', 'Disk Space', and 'Archive', and a right-hand navigation bar with 'Tools', 'Configuration', and 'Admin'. The main content area has a left sidebar with 'User information', 'User permissions', and 'User password' tabs. The 'User information' tab is active, showing a form with the following fields: 'Name *' (containing 'John'), 'Surname *' (containing 'Doe'), and 'Login' (containing 'jdoe123'). A 'Save' button is located at the bottom right of the form area. A 'Back to Users List' link is at the bottom left.

b. **User permissions** tab

Click the new desired role and click the **Save** button.

The screenshot shows the 'User permissions' tab for a user named 'John Doe | Operator'. The interface is similar to the previous screenshot, but the 'User permissions' tab is active in the sidebar. The main content area shows a 'Select role:' section with buttons for 'Administrator', 'Operator' (which is selected), 'Lab leader', and 'Technician'. Below this are buttons for 'Group leader', 'Supervisor', and 'Quality Assurance'. A 'Description: Operator' section contains a text box with the following text: 'The operator is the role inside the laboratory and is designed for Life Science projects. Users with this role will have access to all general QIAcuity instrument control software and QIAcuity Software Suite functionalities required to process plates and analyze results. Deleting plates and access to the user management are restricted for these users.' Below the description is a dropdown menu showing 'show all permissions 27/43'. A 'Save' button is at the bottom right, and a 'Back to Users List' link is at the bottom left.

c. **User password** tab

Change the user's password.

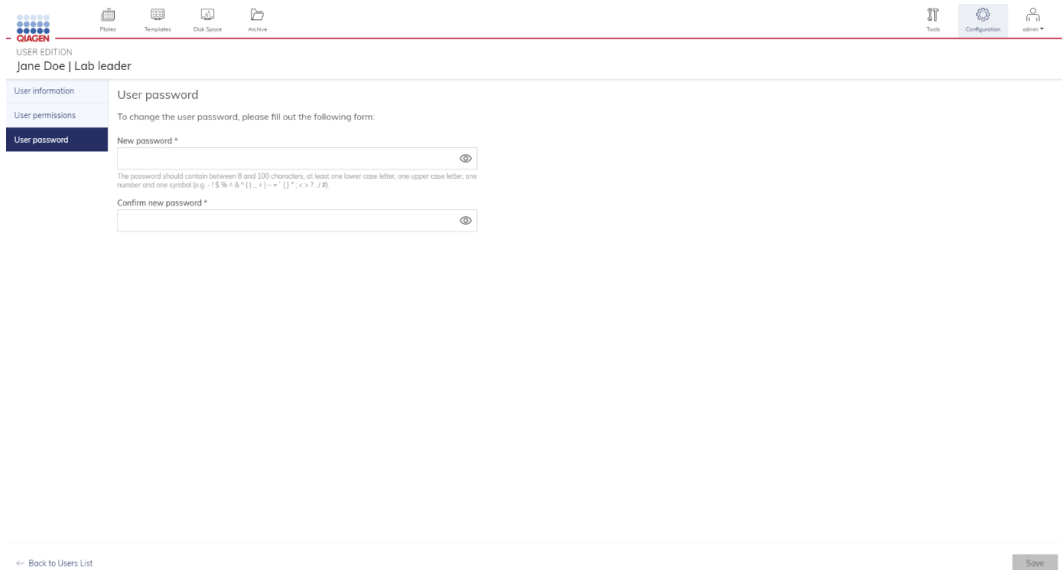

- d. In the “New password” field, enter the new password. In the “Confirm password” field, re-enter the same password as in the “New password” field. Those passwords should be the same. If the passwords entered matched, click the **Save** button.

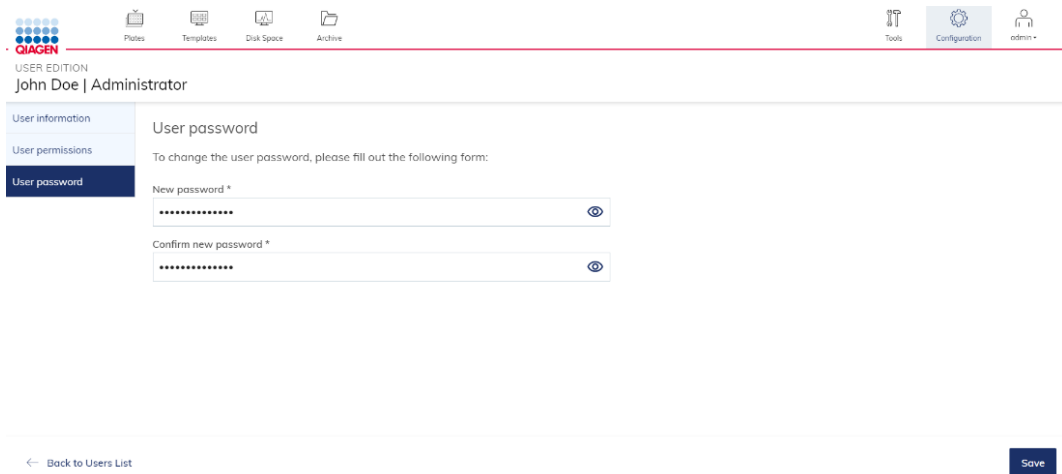

- e. Finally, click the **OK** button to save the changes.

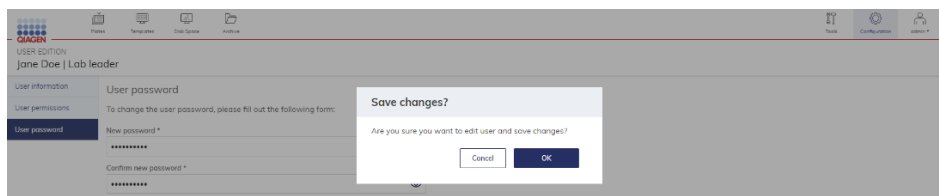

7.2.6. User activation

Deactivated users may be activated by users with “Activate and Deactivate User” permissions to restore their access to the system.

1. In the Users list tab, find the **Show sorting** button.

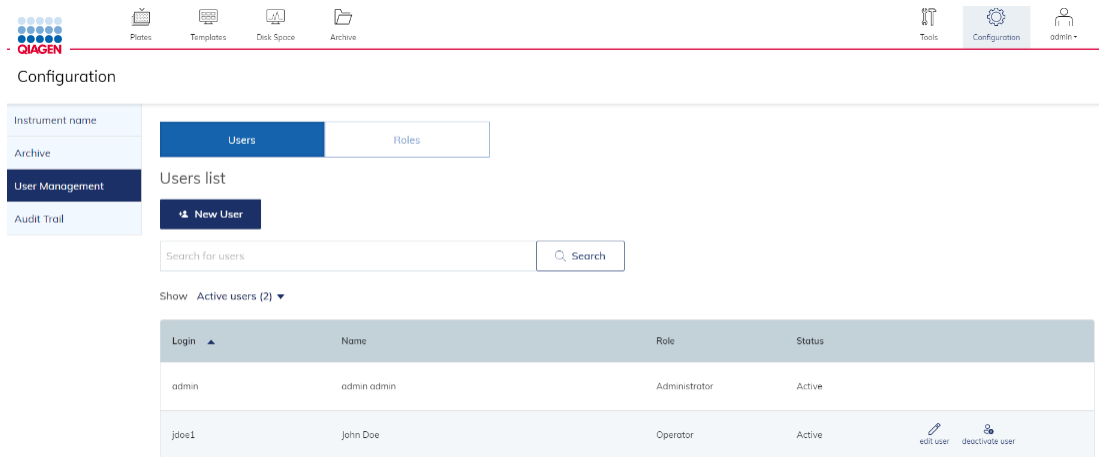

The screenshot shows the QIAGEN Configuration interface. The 'Users list' tab is selected, and the 'Show' dropdown is set to 'Active users (2)'. The table below shows two active users:

Login	Name	Role	Status	
admin	admin admin	Administrator	Active	
jdoo1	John Doe	Operator	Active	edit user deactivate user

2. Change the option to **Deactivated users**. The Users list table shows all deactivated users.

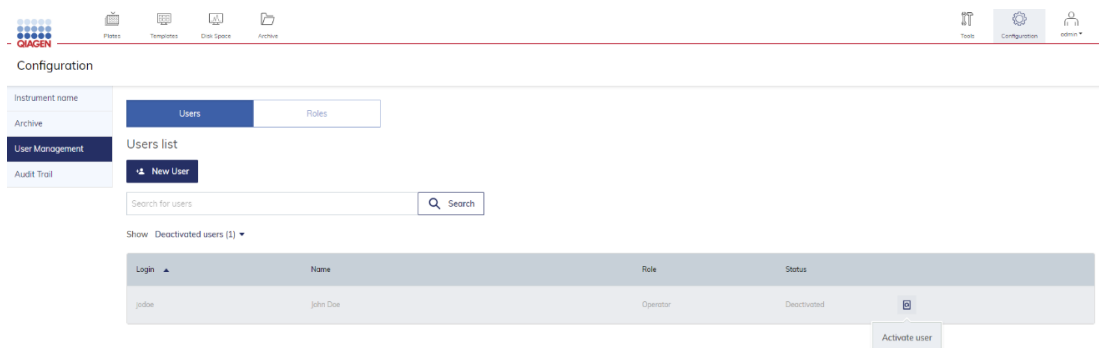

The screenshot shows the QIAGEN Configuration interface. The 'Users list' tab is selected, and the 'Show' dropdown is set to 'Deactivated users (1)'. The table below shows one deactivated user:

Login	Name	Role	Status	
jdoo	John Doe	Operator	Deactivated	Activate user

3. Find the user to activate.
4. Click the **Activate user** icon.
5. When the **Activate** button is clicked, the user is moved to the “Active” and “All” Users list.

7.2.7. User deactivation

Users with Administrator role are able to deactivate other users to restrict access to the system.

Note: It is not possible to delete users.

1. Find the user to deactivate.
2. Click the deactivate user icon.

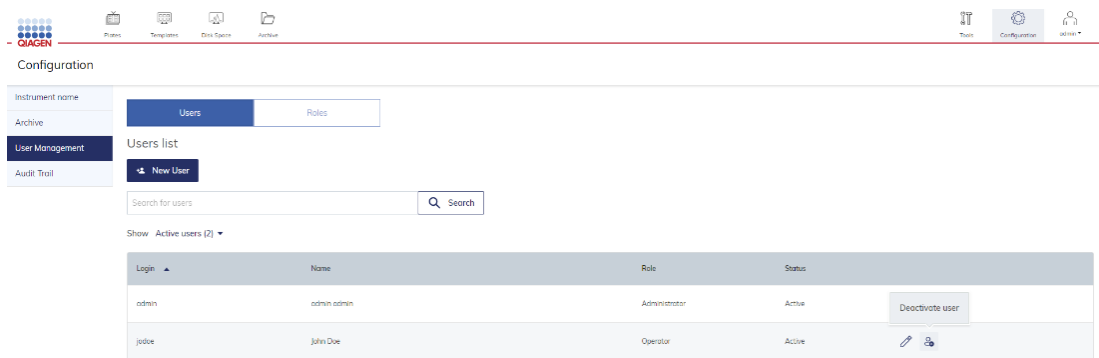

3. Read the information in the pop-up window, and click **Yes** to confirm.

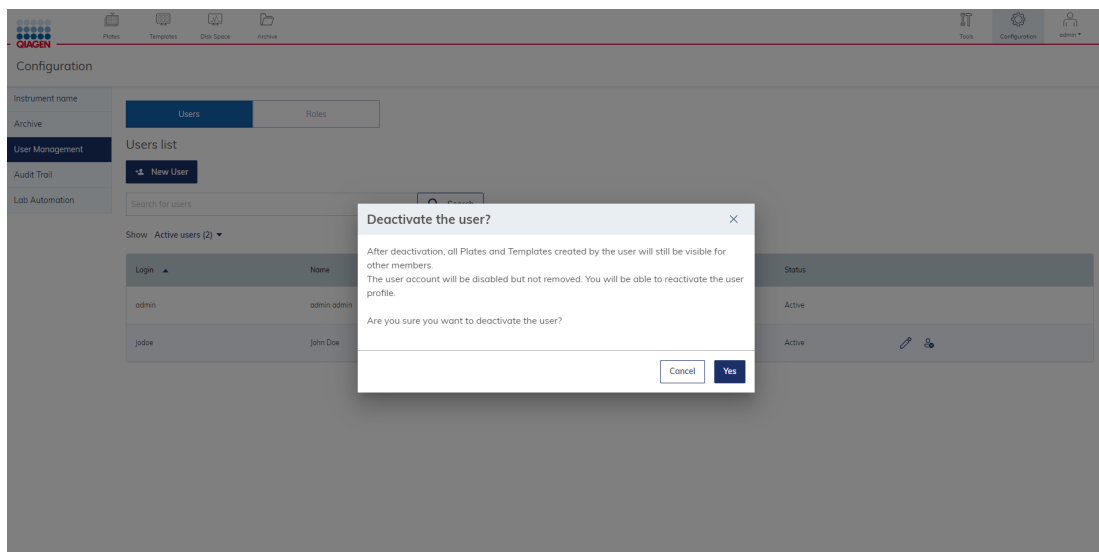

4. After the user is deactivated, all Plates assigned to this user will still exhibit the user as plate owner registered, but marked as deactivated. If the user is activated again, Plate Ownership will be reassigned.
5. Click the **Yes** button to deactivate the user.

7.2.8. Log in (Instrument and PC software)

1. **Instrument** — User can log in to the instrument (login and password is needed).
 - Log into the Instrument by providing credentials.
2. **Software Suite** — User can log in to the Software Suite (PC software) (login and password is needed).
 - Log into the Software Suite by providing credentials
 - Change own password
 - Modify own user data
 - name
 - surname
 - If the user does not have access to log in but provides the correct login and password, then he/she is presented with the following message: "Insufficient permissions. Please contact administrator".

7.2.9. Instrument access (Instrument software)

1. **Instrument Maintenance** — User can update the instrument and go to **Data Management, Self-Check, Servicing, and Configuration**. User is also able to configure the auto log-off time for the instrument.
2. **Experiment Schedule** — User can set up dPCR parameters (priming, cycling, and imaging) and change the order of plates to be processed.
3. **Create Support Package** — User can download a support package to a USB drive and upload a support package.

7.2.10. Plates (Instrument and PC software)

Create Plate — User can set up dPCR parameters (priming, cycling, imaging), reaction mixes (reagents), samples (control, non-control), and create a Plate layout.

- Create a new Plate (fill out General Data and scan barcode).
- Set up dPCR parameters.
- Set up a Plate layout (add/remove [before experiment run] reaction mixes, samples, and controls).

All plates

1. **Run Experiment** — User can run/stop an experiment and eject Plate(s) from instrument.

Note: "Read all Plate" required to have fully available permissions.

 - Start an experiment in the instrument.
2. **Edit Plate Data** — User can check and edit parameters of existing Plates (dPCR parameters, Plate layout (samples, reaction mixes (reagents), controls) and mark it as primed.

Note: The "Read all Plate" permission is required to have the fully available permissions.

3. **Edit Analysis Data** — User can change the threshold and use the polygon selection on the Analysis page of all Plates to verify the accuracy of the results.

Note: The “Read all Plate” permission is required to have the fully available permissions.

4. **Read Plate** — User can search for a specific Plate, see all created Plates, analyze a Plate, check details about a Plate [dPCR parameters, plate layout (samples, reaction mixes, controls)], and export results to CSV.

5. **Delete Plate** — User can delete any Plate.

Note: The “Read all Plate” permission is required to have the fully available permissions.

Owned plates

Applies only to plates for which the user is listed as Plate owner.

1. **Run Experiment** — User can run/stop an experiment and eject owned Plates from the instrument.

Note: The “Read owned Plate” or “Read all Plate” permission is required to have the fully available permissions.

2. **Edit Plate Data** — User can check and edit parameters of owned Plates (dPCR parameters, plate layout (samples, reaction mixes (reagents), controls), and mark it as primed.

Note: The “Read owned Plate” permission is required to have the fully available permissions.

3. **Edit Analysis Data** — User can change the threshold and use the polygon selection on the Analysis page of the owned Plates to verify the accuracy of the results.

4. **Read Plate** — User can search the Plate, analyze the Plate, see all created Plates, check details about owned Plates (dPCR parameters, plate layout (samples, reaction mixes, controls)), and export results to CSV.

5. **Delete Plate** — User can delete owned Plates.

Note: The “Read owned Plate” permission is required to have the fully available permissions.

Other permissions

1. **Import Plate** — User can import a Plate as a password-protected ZIP file.

Note: The “Read owned Plate” or “Read all Plate” permission is required to have the fully available permissions.

- Import plate
 - The **Import Plate** button is visible in the Plates overview.

2. **Export Plate** — User can export a Plate as a password-protected ZIP file.

Note: The “Read owned Plate” or “Read all Plate” permission is required to have the fully available permissions.

- Export plate
 - The **Export Plate** button is visible after clicking the three dots (...) on a plate.
 - The **Export Plate** button is visible in the Plate details view.

3. **Unlock Plate** — User can unlock locked Plates.

Note: The “Read owned Plate” or “Read all Plate” permission is required to have the fully available permissions.

- Unlock plate
 - When a Plate is in locked status, the **Unlock Plate** button is visible in the Plate details.
 - **Note:** Avoid use of the **Unlock Plate** button. If the **Unlock Plate** button is tapped during a run, the run will stop and the data will be lost. Instead, always attempt to properly unlock plate by ejecting the drawer, removing the plate, and closing the drawer. Only tap the **Unlock Plate** button in the rare situation where the plate continues to display a locked status despite being properly removed from the instrument. This can occur in situations where the run is stopped due to an instrument error.

4. **Set Plate Ownership** — User can assign owners to a plate.

Note: The “Read owned Plate” or “Read all Plate” permission and the “Edit owned Plate” or “Edit all Plate” permission are required to have the fully available permissions.

- Set plate ownership
 - The “plate ownership” field in plate general data is active.

5. **Upload VPF** — User can upload the Volume Precision Factor.

- Upload VPF
 - The **Upload VPF** button is visible in the Plates overview.
 - The **Upload VPF** button is visible in the Plate details.
- If the user does not have access rights to upload the VPF, the information displayed is changed as follows:

“The volumes of some nanoplates are not yet optimized. You can work with these results; however, to get the most accurate results, please contact your administrator”.

6. **Upgrade Plate** — User can upgrade the Plate.

Note: The “Read owned Plate” or “Read all Plate” permission is required to have the fully available permissions.

- Upgrade plate
 - The **Upgrade** button is visible on the plate.
 - The **Upgrade** button is visible in the Plate details view.

7. **Create Support Package** — The user can download a support package for the Plate.

Note: The “Read owned Plate” or “Read all Plate” permission is required to have the fully available permissions.

- Create support package
 - The **Support Package** button is visible in the Plate details.

8. **Create Report for Analysis** — User can create and generate a report using the charts and data from the Analysis of the Plate.

Note: The “Read owned Plate” or “Read all Plate” permission is required to have the fully available permissions.

- Add charts to a report.
- Check selected items for a report.
- Create a report (add report name, select or change report elements).
- Generate a report

9. **Sign Report** — User can add a signature to the report.

Note: The “Read owned Plate” or “Read all Plate” permission is required to have the fully available permissions.

- Add a signature and the reason for signing a report.

10. **Delete Report** — User can delete a report.

Note: The “Read owned Plate” or “Read all Plate” permission is required to have the fully available permissions.

- The **Delete report** button is visible in the report list section (only unsigned reports can be deleted)

7.2.1.1. Templates (Instrument and PC software)

If the user has any of the rights regarding templates, the following requirements apply.

The user can go to **Template** (top-bar menu). If the user does not have “Read templates” permissions, the following information is displayed:

To view templates, you need to have “Read templates” permission. Please contact administrator to get access rights.

1. **Create Template** — User can create a new Template.

Note: The “Read Plate” permission is required to be able to create a template from a plate.

- Create a new Plate template.
- Create a new Reaction mix template.
- Create a Plate Template from a plate.
- Create a Reaction mix template from a reaction mix (from the Plate level).

2. **Edit Template** — User can edit an existing Template.

Note: The “Read Template” permission is required to be able to edit a template.

- Modify templates (and their parameters) – Modify Plate templates and Reaction mix templates

3. **Read Template** — The user can read information about existing Templates and use them while creating and editing plates and reaction mixes (if the user also has appropriate plate permissions). This permission provides access to all available templates.

- Go to a Template.
- Read all Templates.

- See all created Templates.
- Search Templates (and sort them).
- Create a Plate from a Template.
 - If the user also has the “create plate” permission
- Import a Template while creating a new Plate or Reaction mix.
 - If the user also has the “create plate” permission
- Import a Template while editing a Plate or Reaction mix.
 - If the user also has the “edit plate” permission

4. **Delete Template** — A user can delete existing Templates.

Note: The “Read Template” permission is required to be able to delete templates.

- Delete templates
 - The **Delete** button is visible after clicking the three dots (...) on a Template.

5. **Create Custom Cross Talk Matrix** — User can create a new Custom Cross Talk Matrix and save it in a Reaction Mix Template. Please refer to the “Custom cross talk matrix” section.

Note: The “Read Plate” and “Create Template” permission is required to be able to create a Custom Cross Talk Matrix.

7.2.12. Archive (PC software)

1. **Plate Archiving** — The user can archive a Plate.

Note: The “Read owned Plate” or “Read all Plate” permission is required to have the fully available permissions.

- Go to **Plates** (top-bar menu).
 - If the user does not have the “Read plates” permission, then the following information is displayed:
 “In order to view plates, you need to have “Read plates” permission. Please contact administrator to get access rights”.
- Archive the Plate (all/owned).
 - The **Archive** button is visible after clicking the three dots (...) on a plate.
 - The **Archive** button is visible in the Plate details.

2. **Archive Overview** — The user has access to the list of archived Plates. The user can see all archived Plates, search for archived Plates, and check general information about the archived Plate and disk space usage for the Archive in the Disk Space monitor.

- Go to the **Archive** and the Disk Space monitor.
- See the archive disk space (in the Disk space monitor).
- See the archived plate.
- Search the archived Plate (sort by Archived date, Plate name, Plate statuses, time frame, and change view).
- See the archived plate general data.

3. **Restore a Plate from the Archive** — User can restore archived Plates.

Note: The “Archive Overview” permission is required to have the fully available permissions.

a. Go to the **Archive** and the **Disk Monitor**.

- If the user does not have the “Archive overview” permission, the following information is displayed:

In order to view archived plates, you need to have “Archive overview” permission. Please contact administrator to get access rights.

b. Restore a plate from the archive.

- The **Restore** button is visible after clicking the three dots (...) on a plate.
- The **Restore** button is visible in the Plate details.

4. **Delete Plate from Archive** — The user can delete any Plate from the Archive.

Note: The “Archive Overview” permission is required to have the fully available permission.

a. Go to the **Archive**.

- If the user does not have the “Archive overview” permissions, the following information is displayed:

In order to view archived plates, you need to have “Archive overview” permission. Please contact administrator to get access rights.

b. Delete a plate from the archive.

- The **Delete** button is visible after clicking the three dots (...) on a plate.
- The **Delete** button is visible in the Plate details.

7.2.13. User management (PC software)

1. **Read Users and Roles** — The user can see the list of users and the list of roles in the system.

- Go to the **Configuration** panel.
- Go to the **User Management** tab.
- Go to the **Users** tab in the **User Management** tab.
- See the list of users.
- Search users.
- Go to the **Roles** tab in the **User Management** tab.
- See the list of roles.

2. **Create and Edit Users and Roles** — User can create and edit a user and create and edit a role.

Note: The “Read user and roles” permission is required to have the fully available permission, otherwise the following information is displayed:

In order to view users/roles list, you need to have “Read users and roles” permission. Please contact administrator to get access rights.

- Go to the **Configuration** panel.
- Go to the **User Management** tab.

- c. Go to the **Users** tab in the **User Management** and create new users or edit existing users.
- d. Go to the **Roles** tab in the **User Management** and create new roles, see permissions list or see users list that are assigned to role and edit existing roles.

Note: The roles designed for GMP/GLP (Administrator, Operator, Lab leader, Technician, Group Leader, Supervisor, and Quality Assurance) cannot be edited.

3. **Activate and Deactivate User** — The user can activate and deactivate a user.

Note: The “Read users and roles” permission is required to have the fully available permissions, otherwise the following information is displayed: “In order to view users, you need to have “Read users and roles” permission. Please contact administrator to get access rights.”

- a. Go to the **Configuration** panel.
- b. Go to the **User Management** tab.
- c. Go to the **Users** tab in the **User Management** and can deactivate user and activate (again) deactivated user.

4. **Delete Role** — User can delete existing roles in the system.

Note: The “Read users and roles” permission is required to have the fully available permission, otherwise the following information is displayed: “In order to view users, you need to have “Read users and roles” permission. Please contact administrator to get access rights.”

- a. Go to the **Configuration** panel.
- b. Go to the **User Management** tab.
- c. Go to the **Roles** tab in the **User Management** and can delete a particular role if no users are assigned to it.

Note: Roles designed for GMP/GLP (Administrator, Operator, Lab leader, Technician, Group Leader, Supervisor, and Quality Assurance) cannot be deleted.

If some users are assigned to a role the deletion of the role is not possible.

7.2.14. System configuration (PC software)

1. **Registered Instrument** — The user can see a list of the registered instruments.

- a. Go to the **Configuration** panel.
- b. Go to the **Instrument names** tab.
- c. See the list of registered instruments

2. **Manage Archive** — The user can edit the Archive location, detach the Archive, turn on/off, and configure the automatic archiving.

- a. Go to the **Configuration** panel.
- b. Go to the **Archive** tab.
- c. Edit the archive location.
- d. Detach the archive.
- e. Set automatic archiving and its parameters.

3. Audit Trail configuration

- a. **View Audit Trail** — The user can see the list of the Audit Trail events, search for specific events, check details of an event, and export it to PDF.
 - Go to the **Configuration** panel.
 - Go to the **Audit trail** tab in the configuration panel.
 - Go to the events list.
 - See audit trail data.
 - Filter audit trail data.
 - Export audit trail data.

4. Turn Audit Trail on and off — The user can turn on/off the Audit Trail (events tracker).

- a. Go to the **Configuration** panel.
- b. Go to the **Audit trail** tab in the **Configuration** panel.
- c. Go to the Audit trail tracker settings.
 - Turn audit trail on and off.

7.2.15. Default Roles

This section describes roles available in the QIAcuity Software Suite and QIAcuity Control Software. Roles may be viewed as the set of permissions and are designed in a way to suit laboratories that need to fulfill Good Manufacturing Practice (GMP)/Good Laboratory (GLP) regulations and Molecular Biology Application (MBA) laboratories as well.

Admin, Supervisor, Group leader, Technician, and Quality Assurance are predefined roles designed for GMP/GLP laboratories, whereas Admin, Lab leader, and Operator are designed for MBA laboratories.

Note: All predefined roles cannot be edited or deleted.

1. Admin

The administrator is the role of the laboratory responsible for configuring the system and providing individual user access and rights. Users with this role have extensive access to the QIAcuity Control Software and QIAcuity Software Suite including the user management and audit trail access rights.

2. Supervisor

The supervisor has extensive access to QIAcuity Control Software and QIAcuity Software Suite functionalities required to process plates and analyze results. Users with this role cannot delete plates and templates, cannot unlock or archive plates, and cannot access the user management. The audit trail functionality is limited to viewing the list of events and provide event details.

3. Group leader

The group leader has access to QIAcuity Control Software and QIAcuity Software Suite functionalities required to process plates, analyze results, and manage archived plates but only for the plates the group leader owns. Users with this role cannot delete plates and templates, cannot unlock plates, and cannot access the user management and audit trail.

4. Technician

The technician has limited access to the QIAcuity Control Software and QIAcuity Software Suite. Users with this role can process (create, run) their own plates and use existing templates to run an experiment.

5. Quality Assurance

The quality assurance role has the rights to check all information about the plate, can import plates, and can create and sign reports. Users with this role have audit trail read access, consisting of viewing and searching events, and showing event details. They can also export audit trail for external review.

6. Lab leader

The lab leader role is designed for labs performing MBA. Users with this role have extensive access to all QIAcuity Control Software and QIAcuity Software Suite functionalities required to process plates and analyze results. This role also allows for basic user management functionalities to read user descriptions and their permissions.

7. Operator

The operator role is designed for labs performing MBA. Users with this role have access to all general QIAcuity Control Software and QIAcuity Software Suite functionalities required to process plates and analyze results. This role cannot delete plates and does not have access to the User management.

Table 10. Default role permissions

	Administrator	Supervisor	Group leader	Technician	Quality Assurance	Lab leader	Operator
Log in							
Instrument	X	X	X	X	X	X	X
Suite Software	X	X	X	X	X	X	X
Instrument accesses							
Instrument Maintenance	X					X	
Experiment Schedule	X	X	X	X		X	X
Create Support Package	X	X	X	X		X	X
Plates							
Create Plate	X	X	X			X	X
All Plates							
Run Experiment	X	X				X	X
Edit Plate Data	X	X				X	X
Edit Analysis Data	X	X				X	X
Read Plate	X	X			X	X	X
Delete Plate	X					X	
Owned Plates							
Run Experiment	X	X	X	X		X	X
Edit Plate Data	X	X	X	X		X	X
Edit Analysis Data	X	X	X	X		X	X
Read Plate	X	X	X	X		X	X

Table 10. Default role permissions (continued)

	Administrator	Supervisor	Group leader	Technician	Quality Assurance	Lab leader	Operator
Delete Plate	X					X	
Other permissions							
Import Plate	X	X	X		X	X	X
Export Plate	X	X	X			X	X
Unlock Plate	X					X	
Set Plate Ownership	X	X	X			X	X
Upload VPF	X	X				X	
Upgrade Plate	X	X	X			X	X
Create Support Package	X	X	X	X		X	X
Create Report for Analysis	X	X	X		X	X	X
Sign Report	X	X	X		X	X	X
Delete Report	X					X	X
Templates							
Create Template	X	X	X			X	X
Edit Template	X	X	X			X	X
Read Template	X	X	X	X	X	X	X
Delete Template	X	X				X	
Create Custom Cross Talk Matrix	X		X			X	
Archive							
Plate Archiving	X	X	X			X	X
Archive Overview	X	X	X		X	X	X
Restore Plate from Archive	X	X	X		X	X	X
Delete Plate from Archive	X					X	
User Management							
Read Users and Roles	X				X	X	
Create and Edit Users and Roles	X						
Activate and Deactivate User	X						
Delete Role	X						
System Configuration							
Registered Instruments	X					X	
Manage Archive	X					X	
Audit Trail Configuration							
View Audit Trail	X	X			X	X	
Audit Trail Toggle	X						

X – role has access to this permission

This section describes how the functionalities in the application are impacted by permissions, which are assigned to user roles. Pay special attention to notes, because some permissions require other ones to work – notes become visible after checking checkbox.

7.2.16. New role creation

All activities related to creating/editing/deleting roles and a list of existing roles can be found within the **User Management** tab in the Roles view.

Note: To read the roles list, the “Read users and roles” permission is required. To create or edit users, the “Create and Edit Users and Roles” permission is required, in addition.

1. To create a new role, click the **New Role** button.

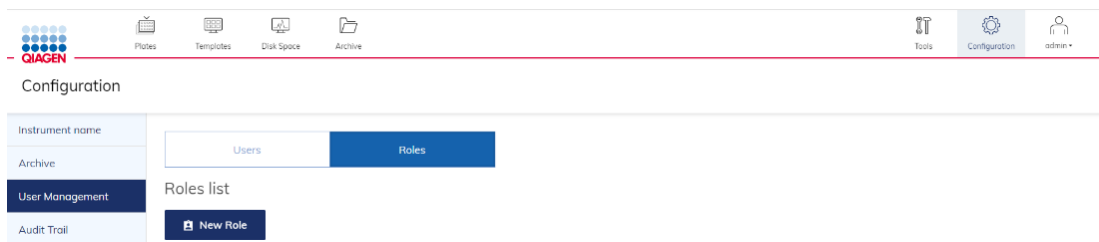

2. Fill out the form: role name and role description.

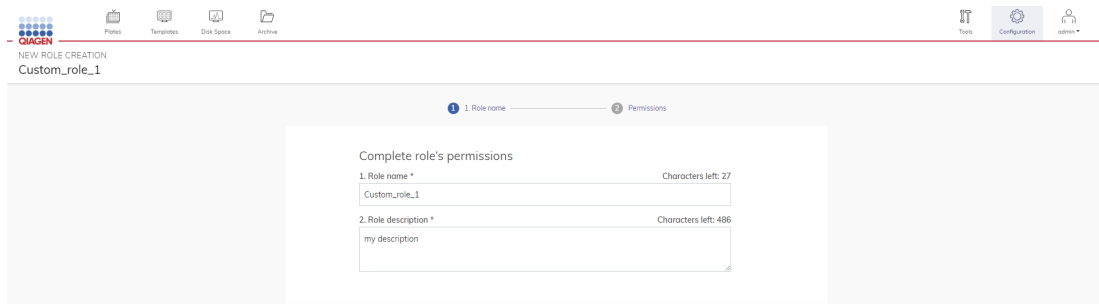

3. When all information is filled out properly, click **Next** or **Permissions** to move to the next step.

- In the Permissions (second) step, user needs to choose the permissions that will be assigned to the role. To speed up selection, use predefined roles as templates and adjust permissions to your needs, then save as new role. Every permission has its own description that can be shown or hidden similarly as when creating or editing Users. Some permissions display useful notes, for example, which permissions should be selected together.

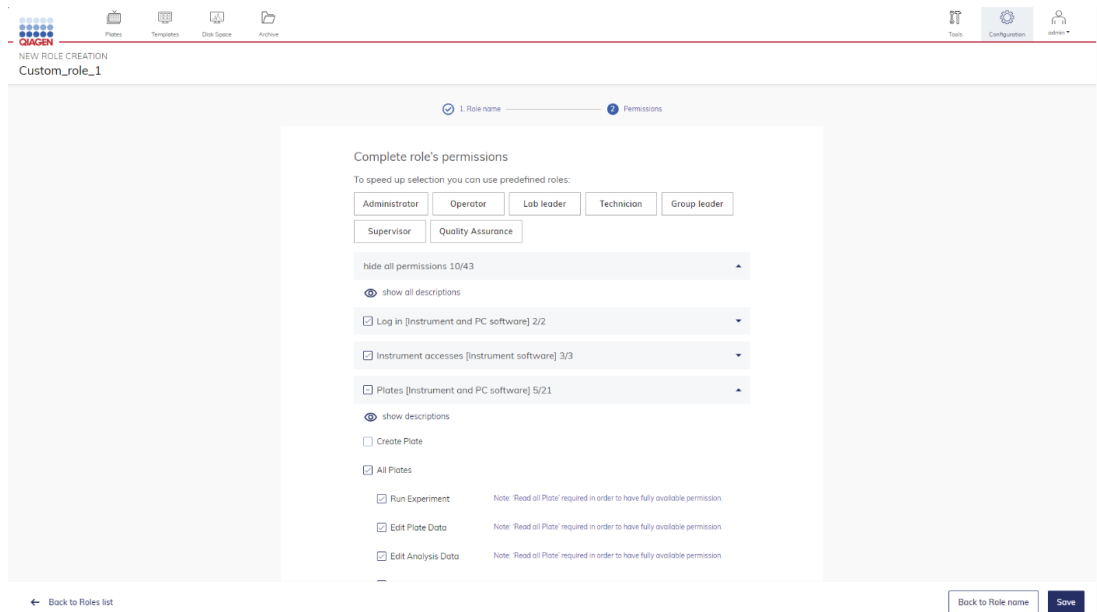

- To go back and check or change the role name, click the **Back to Role name** button or click the Role name step in the stepper.

← Back to Roles list

Back to Role name

Save

- Click the **Save** button to confirm and create the role.

Note: All entries need to be completed under Role name before moving to the Permissions step. The software will indicate any missing information in the Role name step. If any information under Permissions has been entered before having completed all required entries under Role name, all entries will be lost when you hit the **Back to Role name** button.

Note: Creation of a new role needs to be completed by pressing the **Save** button. Otherwise, all changes will be lost in case the **Back to Roles list** is pressed.

From the Roles list, check permissions by pushing the **Permissions list** button.



Permissions list - Custom_role_1 ✕

hide all permissions 10/43 ▲

show all descriptions

Log in [Instrument and PC software] 2/2 ▲

show descriptions

Instrument

Suite Software

Instrument accesses [Instrument software] 3/3 ▼

Plates [Instrument and PC software] 5/21 ▼

Templates [Instrument and PC software] 0/5 ▼

Archive [PC software] 0/4 ▼

User Management [PC software] 0/4 ▼

System configuration [PC software] 0/4 ▼

Close

Pressing the **Users list** button directs user to the list of all users and their status.



Custom_role_1 - Users list ✕

User name	User login	Status	
1. John Doe	jdoe	Active	

Close

7.2.17. Editing existing role







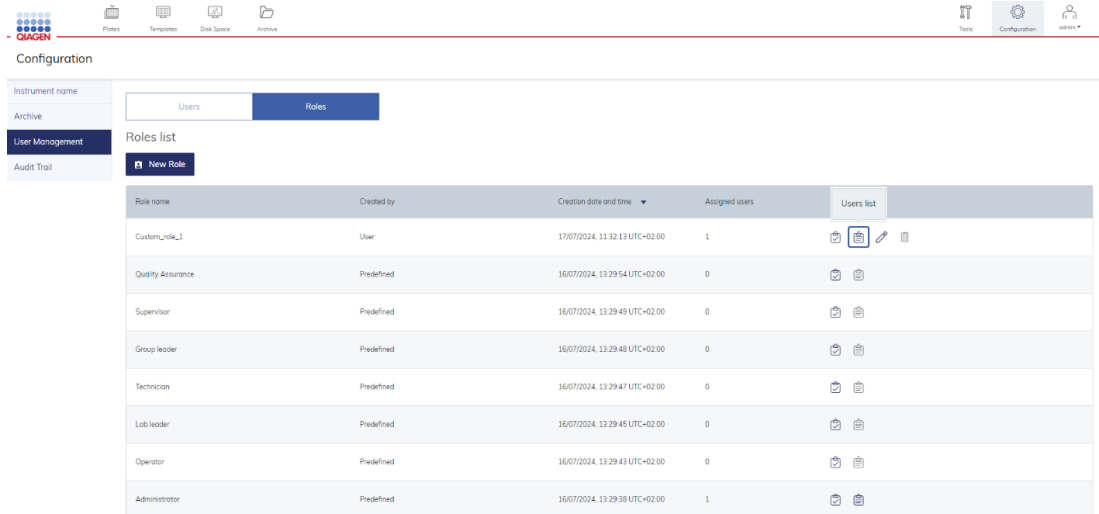









Note: Editing a Role requires the “Create and Edit Roles” permissions. Only roles created by users can be edited. Predefined roles cannot be edited.

To edit a role, follow the instructions below:

1. On the roles list, find the role for editing.



The screenshot shows the QIAGEN Configuration interface. The left sidebar contains navigation options: Instrument name, Archive, User Management (selected), and Audit Trail. The main content area is titled 'Roles list' and features a 'New Role' button. A table lists various roles with columns for Role name, Created by, Creation date and time, Assigned users, and Users list. The 'Custom_role_1' role is highlighted, indicating it is the one being edited.

Role name	Created by	Creation date and time	Assigned users	Users list
Custom_role_1	User	17/07/2024, 11:32:13 UTC+02:00	1	  
Quality Assurance	Predefined	16/07/2024, 13:29:54 UTC+02:00	0	 
Supervisor	Predefined	16/07/2024, 13:29:49 UTC+02:00	0	 
Group leader	Predefined	16/07/2024, 13:29:48 UTC+02:00	0	 
Technician	Predefined	16/07/2024, 13:29:47 UTC+02:00	0	 
Lab leader	Predefined	16/07/2024, 13:29:45 UTC+02:00	0	 
Operator	Predefined	16/07/2024, 13:29:43 UTC+02:00	0	 
Administrator	Predefined	16/07/2024, 13:29:38 UTC+02:00	1	 

2. Click the **Edit role** button.



3. On the left-hand side are two tabs related to role information and role permissions.

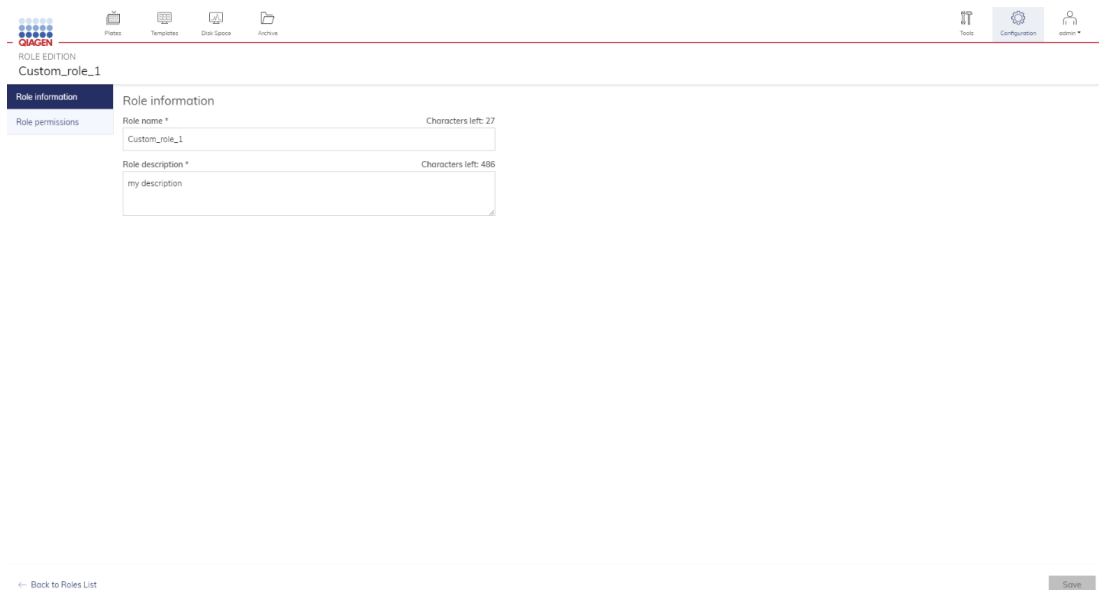

The screenshot shows the 'ROLE EDITION' page for 'Custom_role_1'. The left sidebar has 'Role information' (selected) and 'Role permissions' tabs. The main content area contains a form with two input fields: 'Role name *' with the value 'Custom_role_1' and 'Characters left: 27', and 'Role description *' with the value 'my description' and 'Characters left: 406'. At the bottom, there is a 'Back to Roles List' link and a 'Save' button.

a. **Role information** tab

Change role name and description. To edit a user name or surname, click the input field and type the new value.

b. **Role permissions** tab

Change permissions assigned to a role. Select permissions using checkboxes, then click the **Save** button.

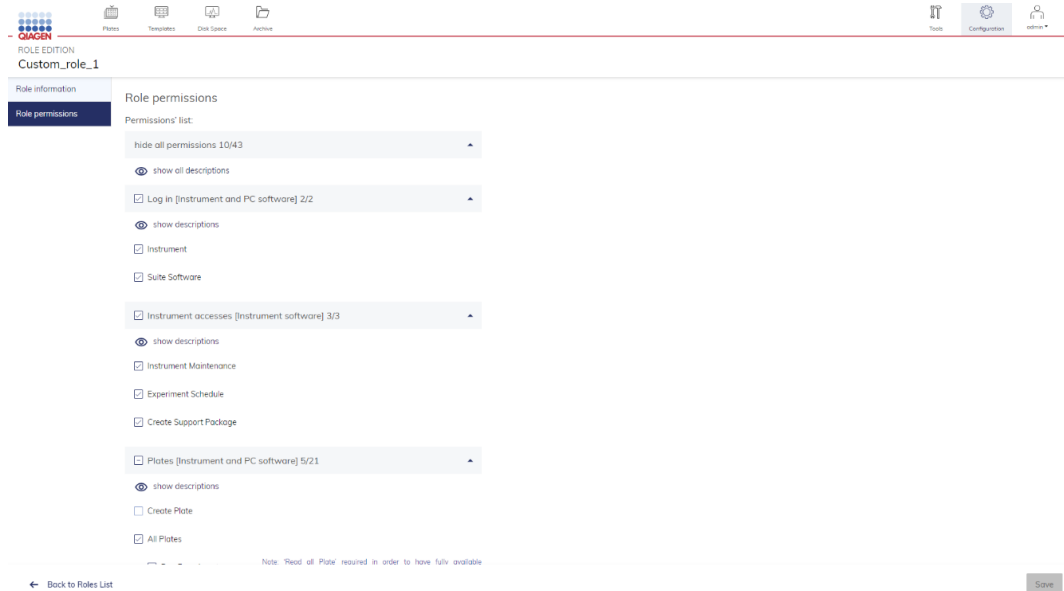

c. When there are users assigned to the role being modified, a pop-up window will appear after the **Save** button is pressed, showing a list of users that will be impacted by the change.

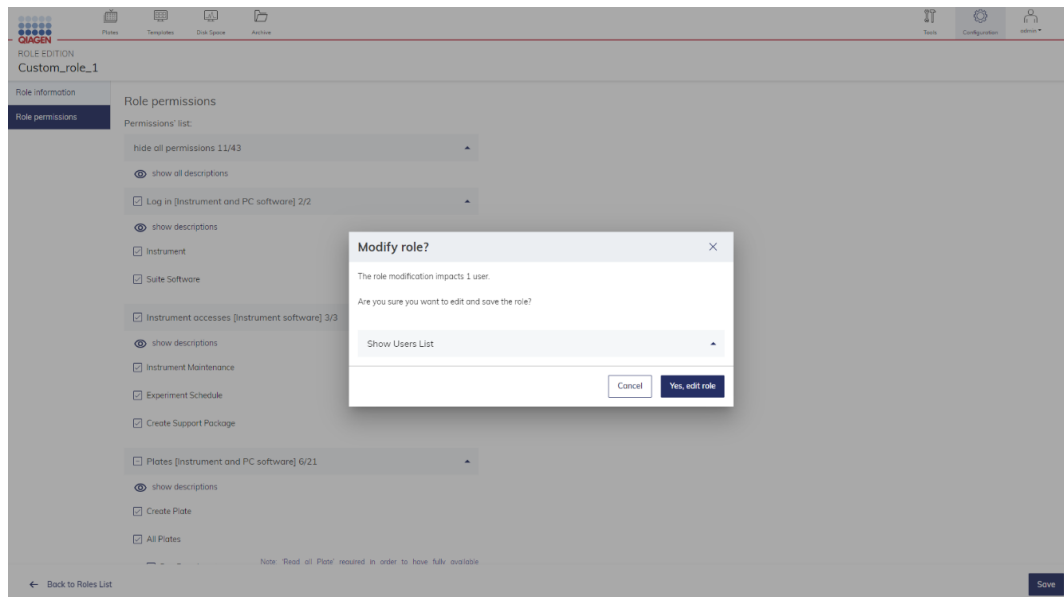

d. To confirm changes, click the **Yes, edit role** button.

If no users are assigned to the role being modified, the confirmation window will not appear.

7.2.18. Role deletion

Note: Deleting a Role requires the “Delete role” permission. Only roles created by users with no users assigned can be deleted. Predefined roles cannot be deleted.

To delete a role, follow the instructions below:

1. On the roles list, find the role for deletion:

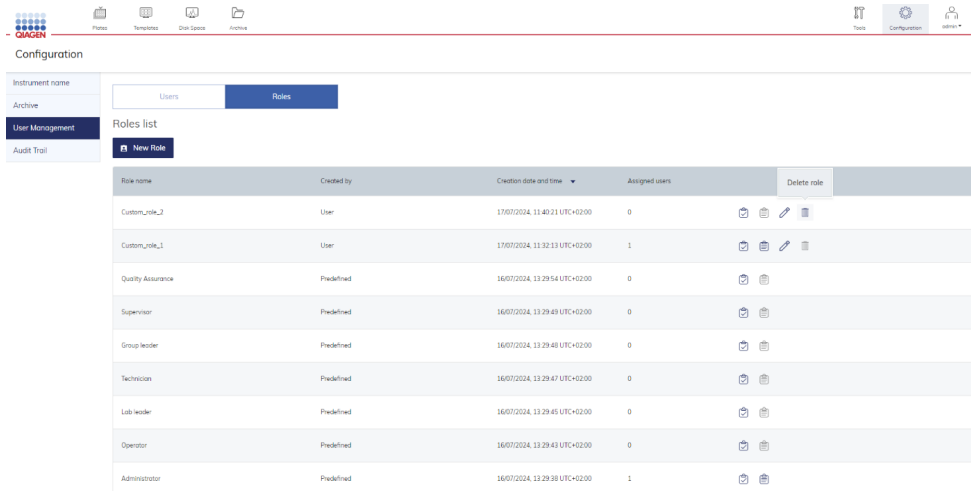

The screenshot shows the QIAGEN Configuration interface. The 'Roles list' table contains the following data:

Role name	Created by	Creation date and time	Assigned users	Delete role
Custom_role_2	User	17/07/2024, 11:40:21 UTC+02:00	0	
Custom_role_1	User	17/07/2024, 11:32:13 UTC+02:00	1	
Quality Assurance	Predefined	16/07/2024, 13:29:54 UTC+02:00	0	
Supervisor	Predefined	16/07/2024, 13:29:49 UTC+02:00	0	
Group leader	Predefined	16/07/2024, 13:29:48 UTC+02:00	0	
Technician	Predefined	16/07/2024, 13:29:47 UTC+02:00	0	
Lab leader	Predefined	16/07/2024, 13:29:45 UTC+02:00	0	
Operator	Predefined	16/07/2024, 13:29:43 UTC+02:00	0	
Administrator	Predefined	16/07/2024, 13:29:38 UTC+02:00	1	

2. Click the **delete role** button.



Note: If users are assigned to the role, the **Delete role** button becomes inactive (gray) and a tooltip is presented indicating that the role cannot be deleted.

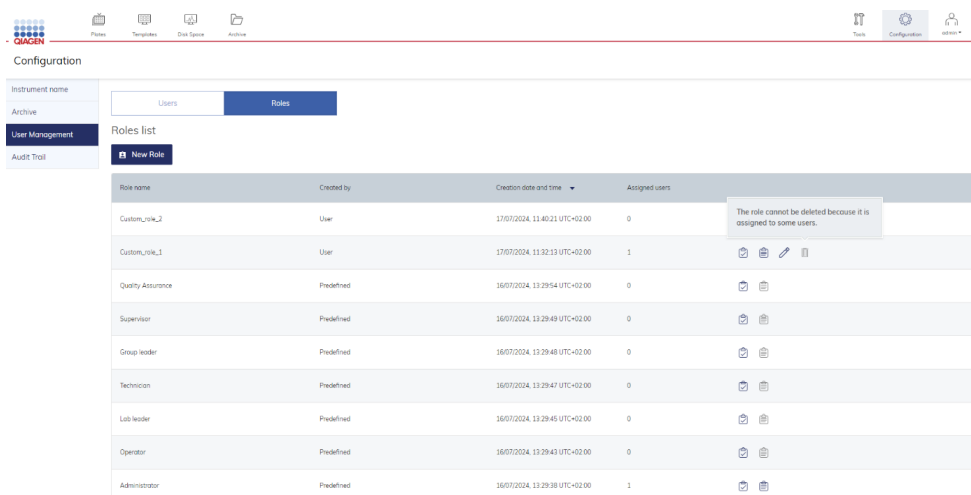

The screenshot shows the QIAGEN Configuration interface. The 'Roles list' table is the same as in the previous screenshot. A tooltip is displayed over the 'Delete role' button for 'Custom_role_1', containing the text: "The role cannot be deleted because it is assigned to some users."

7.3. Setting up an experiment

This section provides information about the steps required to set up a new experiment.

7.3.1. Creating a new plate

1. Click **Plates** in the main toolbar to enter the plates environment.

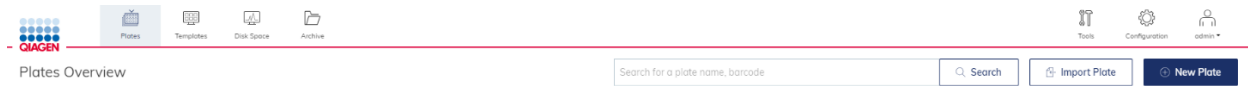

2. Click **New Plate**.



3. Refer to Table 11 to provide the following required information in each tab:

General Data
dPCR parameters
Reaction mixes
Samples & controls
Plate layout

Table 11. Required steps in creating a plate

Tab	Steps
General data	Enter the basic information about the plate: <ul style="list-style-type: none">• Plate name• Plate type• Description• Labels• Plate ownership• Barcode
dPCR parameters	Specify the following information: <ul style="list-style-type: none">• Priming profile• Cycling• Imaging
Reaction mixes	Provide the following information for a new reaction mixes: <ul style="list-style-type: none">• Reaction mix name• Color• Target Name• Dye• Channel
Samples & Controls	Specify the following information for a new sample: <ul style="list-style-type: none">• Sample name• Labels• Amount• Description Specify the following information for a new control: <ul style="list-style-type: none">• Control name• Specify the following information for a new non-template control• Non Template Control name
Plate layout	Provide the following information: <ul style="list-style-type: none">• Add reaction mix• Mark as blank• Add sample• Add control• Add NTC

7.4. Plate configurator

7.4.1. Defining general data

NEW PLATE CONFIGURATOR
Plate without a name

General Data

dPCR parameters

Reaction mixes

Samples & controls

Plate layout

General Data

Plate name *

Plate type
Choose plate type

Description

Labels Labels left: 10
Confirm each label with 'Enter' button

Plate Ownership *
admin admin (admin) add user
Type user name, surname or login to add user

Barcode
You may scan it using USB scanner, enter it now or scan it later, by the instrument

Recommended next step: dPCR parameters

Back to plates Save changes Done

In the **General Data** tab, specify the basic information about the plate. Mandatory input fields are marked with an asterisk. The plate name is required to save a plate.

Note: Make sure that the selected plate type corresponds with the entered barcode, if manually entered. If they do not match, it will lead to an error on the instrument (error 205).

Table 12. General data tab

Field	Field Help
Plate name	Specify the name of the plate.
Plate type	Select the plate type from the list. You can select Nanoplate 26K 8-well, Nanoplate 26K 24-well, Nanoplate 8.5K 24-well, or Nanoplate 8.5K 96-well.
Description	Enter a descriptive information about your experiment.
Labels	Add labels to your plate to help you categorize your experiments.
Plate ownership	Enter users that should be allowed to view and edit the plate according to their permissions. More than one user can be a Plate owner.
Barcode	Enter the barcode that is located on the side of the plate. Barcodes are unique to each plate and can only be used once.

7.4.2. Plate ownership

The Plate Ownership allows users to assign one or more users to a specific plate. A user who creates a new plate, imports a plate, or restores a plate from the archive is assigned automatically as an owner of the plate.

Note: For imported or restored plates, the operating user will automatically be added as the plate owner if no plate owner is already assigned to the plate or if the assigned plate owner is deactivated. For upgraded plates, owners from the original plate will be preserved if they exist in the current QIAcuity Software Suite; otherwise, the operating user will be set as the plate owner.

7.4.3. Assigning the owner of the plate

1. On the **Plates** tab (Plates Overview), find the plate to which ownership must be assigned.
2. In the **General Data** tab, the “Plate Ownership” field is displayed (below “Labels”).

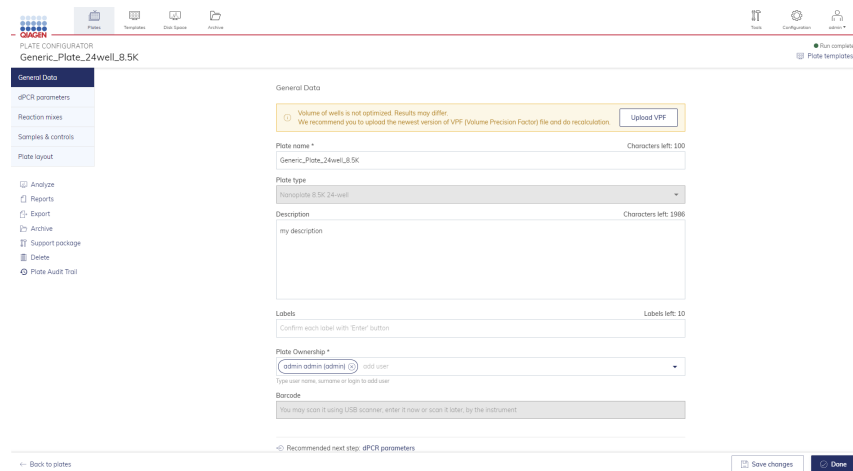

3. Click the “Plate Ownership” input field.



4. Start writing the user name/surname/login.

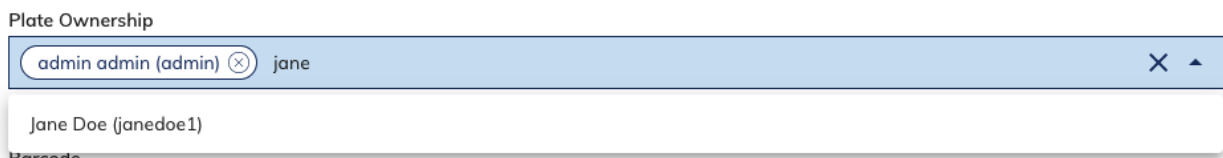

5. Choose the user from drop-down list by clicking the chosen name.

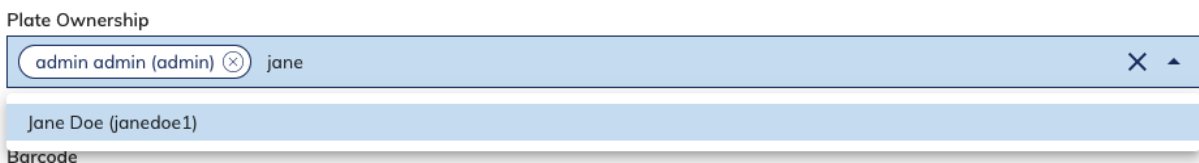

6. User has been added.



7. To add another user, begin typing the user name/surname/login; user will appear in the drop-down list and can be chosen as desired.

8. Click the **Done** button to save changes.

7.4.4. Removing an owner of the plate

1. To remove one owner of a plate, click the **close** icon placed within the user name tag.



2. To remove all owners, click the **clear** icon on the end of the input field.



3. Click the **Done** button to save changes.

7.4.5. Defining the dPCR parameters

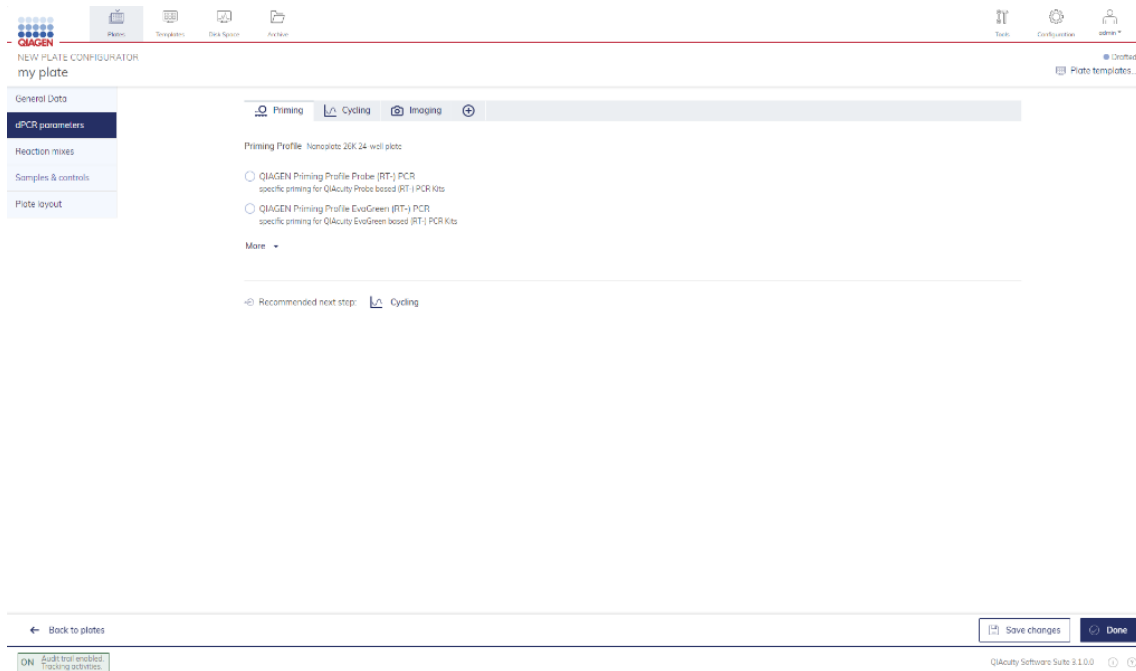

The run profile of each experiment is configured in the **dPCR parameters** tab. This tab is divided into three subtabs: **Priming**, **Cycling**, and **Imaging**.

Priming tab

Select the priming profile applicable for the plate and your type of experiment in the **Priming** tab.

Priming Profile Nanoplate 26K 24-well plate

QIAGEN Priming Profile Probe (RT-) PCR
specific priming for QIAcuity Probe based (RT-) PCR Kits

QIAGEN Priming Profile EvaGreen (RT-) PCR
specific priming for QIAcuity EvaGreen based (RT-) PCR Kits

More ▾

Recommended next step: Cycling

Cycling tab

dPCR parameters

Temperature * °C Duration * mm:ss Add step

Cycling profile

Start (room temperature)	End	Delete	Group	Ungroup
1 x	95 °C 02 min 00 s	↓	↑	⋮
40 x	95 °C 00 min 10 s	↓	↑	⋮
	55 °C 00 min 15 s			
	72 °C 00 min 15 s			

End

Recommended next step: Imaging

Define the temperature profile of each experiment in the **Cycling** tab. To do this, follow these steps:

1. In the “Temperature” field, specify the temperature of the step, then specify the duration of the temperature step in the “Duration” field.
2. Click **Add Temperature Step**.
3. The temperature step is added to your cycling profile.
4. Repeat steps 1–2 for all temperature steps.

Note: Use the up and down arrows to arrange the order of the temperature steps.

5. Check the box corresponding to the desired temperature steps for the repeated cycling. Then, click **Group**.

6. In the first column of the grouped temperature steps, add the number of cycles.

Note: To separate the grouped temperature steps, check the box corresponding to the group, then click **Ungroup**. To delete a temperature step, check the box corresponding to the step, then click **Delete**. The three-dotted icon in each temperature step enables you to edit or delete the step.

Important: Temperature values between 40°C and 99°C can be entered.

Gradient cycling

Working with non-optimized annealing temperatures in PCR can influence the sensitivity or specificity of the amplification reaction. On the one hand, low annealing temperatures can lead to unspecific binding and amplification of unwanted products, whereas too high annealing temperatures could cause the exclusion of the desired product.

The essential temperature gradient function allows for cycling at different temperatures across the columns of a QIAcuity Nanoplate. This feature shall support assay development to easily identify optimal temperature in a single plate run.

The temperature gradient functionality can be used with every QIAcuity instrument type running with QIAcuity Software Suite version 2.5 or higher. The temperature gradient functionality has been developed based on the integrated cycler included in all QIAcuity instruments, allowing users of older instruments to also take advantage of this new feature. The QIAcuity Software Suite offers a functionality to run a temperature gradient on a QIAcuity Nanoplate 8.5K 96-well, only. However, the optimal temperature defined for a QIAcuity Nanoplate 8.5K 96-well can be transferred to all other QIAcuity Nanoplate formats.

Two pre-defined temperature ranges are available. A temperature range from 55°C to 42°C is for RT-PCR related applications and a range from 64°C to 52°C is for standard PCR-related applications. The temperature distribution per well (based on the selected gradient can be previewed and provided in the Plate layout within the QIAcuity Software Suite.

Please note that the two different gradient cycling profiles cannot be combined within one plate. Furthermore, the pre-defined temperature ranges cannot be modified and no custom temperature profiles can be created.

dPCR parameters

Priming Cycling Imaging +

Fixed temperature Gradient

Temperature * 55-42 °C 64-52 °C Duration * mm:ss Add step

Cycling profile

No temperature steps defined yet. Create first one above.

Recommended next step: Imaging

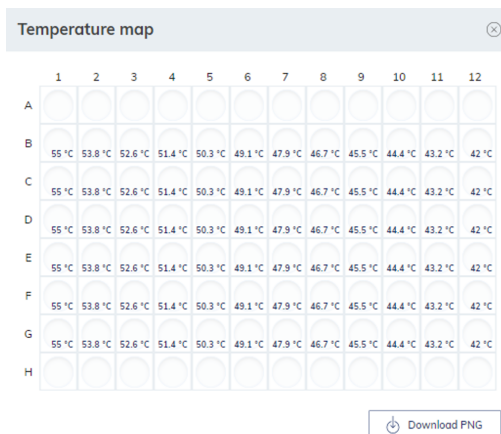

Selection of optimum temperature can be based on multiple criteria. The most common criteria are the signal-to-noise ratio (S/N), the presence or absence of rain, and concentration results. The selected optimum temperature should allow the highest signal-to-noise ratio, minor to no rain and that the obtained concentration reflects the expected results. Finding the optimum temperature is also important to minimize primer mismatch, which could lead to cross-hybridization issues in a multiplex reaction mix.

The selected optimal condition can be verified by a new plate run using the standard cycling program with the optimum temperature found after using the gradient cycling functionality.



Example of gradient temperature cycling results.

The first and last rows (rows A & H) of a QIAcuity Nanoplate 8.5K 96-well are not available for the gradient functionality. There is no possibility within the QIAcuity Software Suite to add reaction mixes and samples/controls to the disabled wells.

Imaging tab

The screenshot shows the 'Imaging' tab in a software interface. At the top, there are tabs for 'Priming', 'Cycling', and 'Imaging'. Below the tabs, there is a section for 'Enable High-Multiplexing-Reference channel' with a toggle switch and an information icon. The main area is divided into columns for 'Channel', 'Exposure duration', and 'Gain'. The channels listed are Green, Yellow, Orange, Red, and Crimson, each with a corresponding color dot and a toggle switch. Below these, there are two rows for 'Channels available for high multiplex instruments only', each with a 'Select channel' dropdown menu. At the bottom, there is a 'Recommended next step' section with a link to 'Reaction mixes'.

Channel	Exposure duration	Gain
Green	300 ms	6
Yellow	250 ms	4
Channels available for high multiplex instruments only		
Orange	150 ms	3
Red	150 ms	3
Crimson	300 ms	4
Far red		
Select channel		
Select channel		

Recommended next step: [Reaction mixes](#)

The **Imaging** tab enables user to set the respective exposure duration and gain value for each channel. The channel options depend on the connected instrument. The QIAcuity multiplex instruments support dPCR assays up to 8-plex by using six optical channels for six standard dyes and the additional use of two channel combinations for LSS (Long Stokes Shift), which can be selected from five different channel combinations. The QIAcuity One, 2 plex offers only two detection channels. The following table shows the available channels provided in each instrument.

Note: The instruments offer an exposure duration from 1 to 4000 ms and a gain value of 0–40 dB.

Table 13. QIAcuity instruments and their available channels

Instrument	Available channels
QIAcuity One, 2plex	Green Yellow
QIAcuity One	Green Yellow Orange Red Crimson Far red + two combinations from Green/Yellow, Yellow/Orange, Orange/Red, Red/Crimson, Crimson/Far red
QIAcuity Four	Green Yellow Orange Red Crimson Far red + two combinations from Green/Yellow, Yellow/Orange, Orange/Red, Red/Crimson, Crimson/Far red
QIAcuity Eight	Green Yellow Orange Red Crimson Far red + two combinations from Green/Yellow, Yellow/Orange, Orange/Red, Red/Crimson, Crimson/Far red

High multiplexing

On all QIAcuity instruments (excluding QIAcuity One, 2 plex), high multiplex experiments, up to 8-plex analysis can be performed by using six optical channels for six standard dyes and the additional use of two channel combinations for LSS (Long Stokes Shift) dyes. Two out of five different LSS channel combinations (Green/Yellow, Yellow/Orange, Orange/Red, Red/Crimson, Crimson/Far red) require the High-Multiplexing-Reference channel. If any of the above channels is selected on the **Imaging** tab, the system will automatically enable the required reference channel and the user cannot disable it. It is also possible to activate the High-Multiplexing-Reference channel for standard channel usage.

Using High-Multiplexing-Reference channel allows to perform additional multiplexing type – Amplitude multiplexing on each type of optical channel and channel combinations. Refer to “Amplitude multiplexing” and “Absolute quantification” sections for more details.

Note: Enabling the High-Multiplexing-Reference channel requires using the QIAcuity High Multiplex Kit, which includes a reference dye dedicated for high multiplexing purposes.

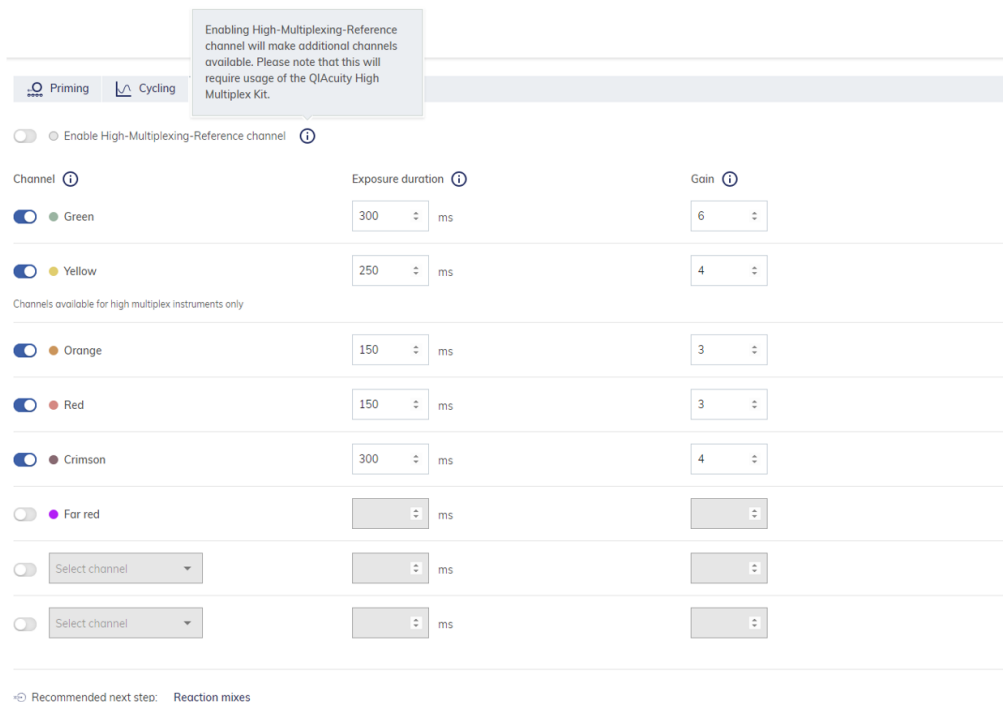

The following actions can be performed when each run is finished:

1. To reimage the plate with different settings, click **+**, then select **Imaging**.
2. To rerun the plate with additional cycles, click **+**, then select **Cycling + Imaging**.
 - a. **Important:** After a run is finished, remove the plate from the instrument before adding a new imaging or cycling + imaging step.

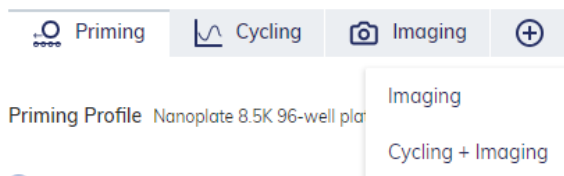

Note: For QIAcuity Software Suite v2.0 or higher, dust detected in one channel is used for identifying dust in other channels as well. If required, to improve dust detection, always image in all channels even when they are not used by the assay(s).

7.4.6. Reaction mixes tab

Create a new reaction mix or import a reaction mix from a template for each experiment (plate) on the **Reaction mixes** tab.

The **General View** tab displays the name of all reaction mixes used in the plate.

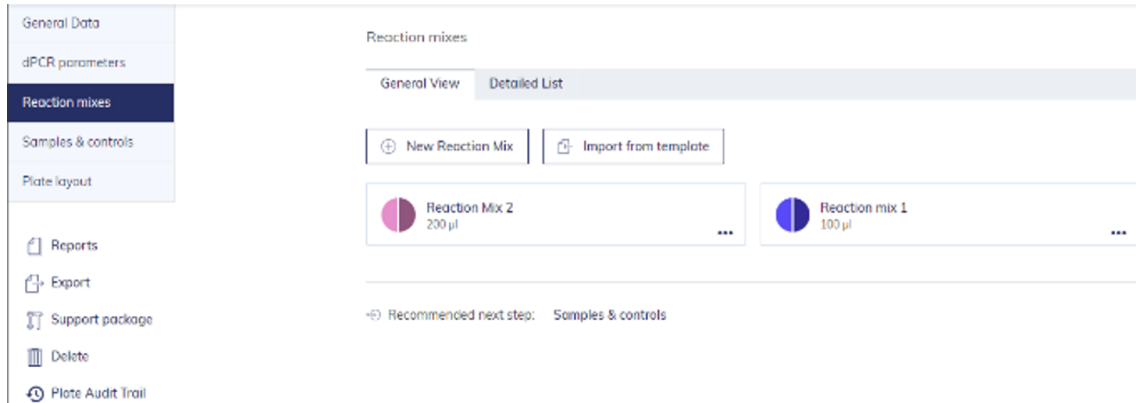

To edit, delete, or save the reaction mix as template, click the three-dotted icon.

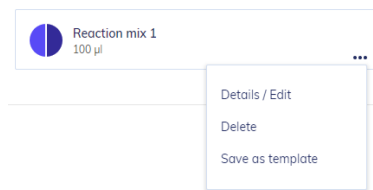

The **Detailed List** view tab displays the detailed information about the reaction mixes assigned to a plate.

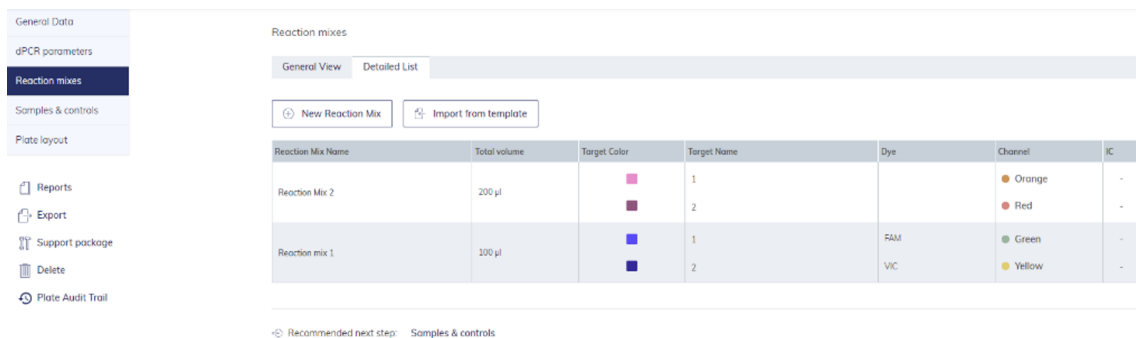

Creating new reaction mix

To create a new reaction mix:

1. Click **New Reaction Mix**.
2. The New Reaction Mix window appears.

Color	Target Name *	Dye	Channel(s) *	Internal control
	Name	Select	Select channel	<input type="checkbox"/>
	Name	Select	Select channel	<input type="checkbox"/>
	Name	Select	Select channel	<input type="checkbox"/>
	Name	Select	Select channel	<input type="checkbox"/>
	Name	Select	Select channel	<input type="checkbox"/>
	Name	Select	Select channel	<input type="checkbox"/>
	Name	Select	Select channel	<input type="checkbox"/>
	Name	Select	Select channel	<input type="checkbox"/>

3. Enter the name of the reaction mix in the "Reaction mix name" field. The name must be unique and must not contain any special characters. Up to 100 characters can be entered in this field.
4. Click the **Change color** button to select a color for the reaction mix.
5. **Optional:** To use the dilution calculation function during the analysis, enter the total volume. Refer to the section "Dilution calculation option" for further details.

Enter a target name in the "Target Name" field. The name must be unique and must not contain any special characters. Up to 40 characters can be entered in this field.

Note: The "Color box" shows the color of the single target in the reaction mix.

6. **Optional:** For amplitude multiplexing target definition, expand the section "Amplitude Multiplexing" and use checkboxes to select the channel/s for which amplitude multiplexing target option should be applied or use the option **select all**. The selected channel/s will be subdivided into High and Low for dedicated target definition.

Note: Amplitude multiplexing requires the use of the High-Multiplexing Reference channel. If this option is selected, a warning is displayed to ensure that the High-Multiplexing Reference channel is enabled in the imaging settings.

New Reaction Mix

Warning (1)

When selecting Amplitude Multiplexing, please ensure that High-Multiplexing-Reference channel in imaging parameters is enabled.

Reaction mix name * Characters left: 100 Total volume μl

Amplitude multiplexing

Select all Green Yellow Orange Red Crimson Far red Green / Yellow

Yellow / Orange Orange / Red Red / Crimson Crimson / Far red

Color	Target Name *	Dye	Channel(s) *	Internal control
<input type="checkbox"/>	<input type="text" value="Name"/>	Select	Select channel	<input type="checkbox"/>
<input type="checkbox"/>	<input type="text" value="Name"/>	Select	Green (Low)	<input type="checkbox"/>
<input type="checkbox"/>	<input type="text" value="Name"/>	Select	Green (High)	<input type="checkbox"/>
<input type="checkbox"/>	<input type="text" value="Name"/>	Select	Yellow (Low)	<input type="checkbox"/>
<input type="checkbox"/>	<input type="text" value="Name"/>	Select	Yellow (High)	<input type="checkbox"/>
<input type="checkbox"/>	<input type="text" value="Name"/>	Select	Orange (Low)	<input type="checkbox"/>
<input type="checkbox"/>	<input type="text" value="Name"/>	Select	Orange (High)	<input type="checkbox"/>
<input type="checkbox"/>	<input type="text" value="Name"/>	Select	Select channel	<input type="checkbox"/>
<input type="checkbox"/>	<input type="text" value="Name"/>	Select	Select channel	<input type="checkbox"/>

7. Select the channel from the channel list where each target is detected.
8. **Optional:** Select the dye of the target from the dye list. Selecting a dye automatically sets the associated channel in the Channel list. Recommended dyes for particular channels are collected and presented in Table 2 in this user manual.
9. If the target is an internal control, check the "Internal control" box.

Note: Clicking the trash icon deletes all entries in the corresponding row.
10. Click **Create**.
11. The reaction mix is added to the database and can be used for the experiment.

7.4.7. Saving reaction mixes as templates

From QIAcuity Software Suite version 3.1 onwards, existing reaction mixes can be saved as Reaction mix templates for later usage in other experiments.

To save an existing reaction mix as Reaction mix template:

1. Click the three-dotted icon of the reaction mix and select the **Save as template** option.

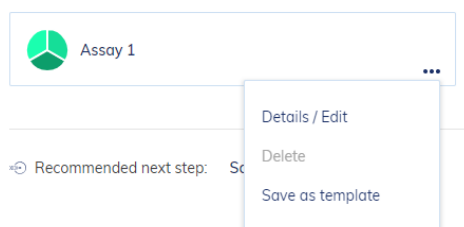

2. Save as reaction mix template window appears.

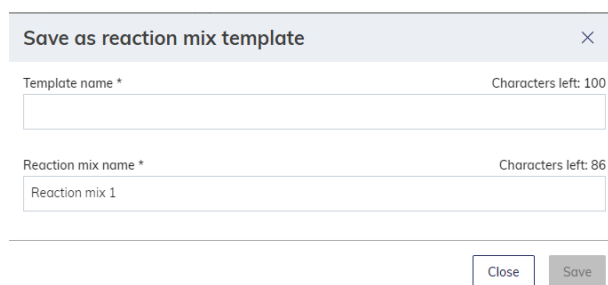
A screenshot of the 'Save as reaction mix template' dialog box. The dialog has a title bar with a close button. It contains two input fields. The first is 'Template name *' with 'Characters left: 100'. The second is 'Reaction mix name *' with 'Characters left: 86' and the text 'Reaction mix 1' entered. At the bottom right, there are 'Close' and 'Save' buttons.

3. Enter the name of the template in the "Template name" field and the name of the reaction mix in the "Reaction mix name" field. The template name must be unique and both fields must not contain any special characters. Up to 100 characters can be entered in those fields.
4. Click **Save**.
5. The reaction mix template is added to the system database and can be imported in other experiments.

Importing reaction mixes from templates

Reaction mixes saved as templates can be imported to another experiment:

1. Click the **Import from template** button.

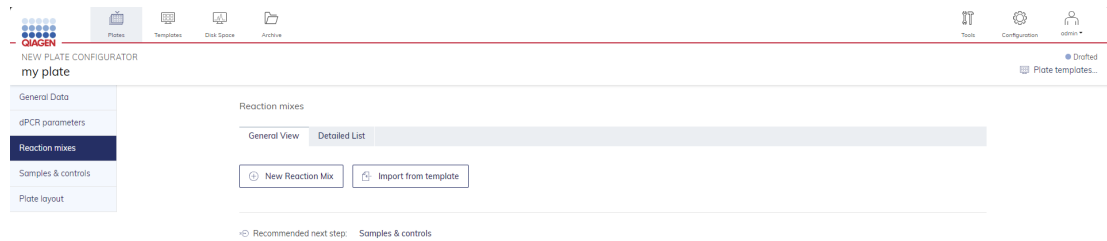

2. Import reaction mix template window appears.

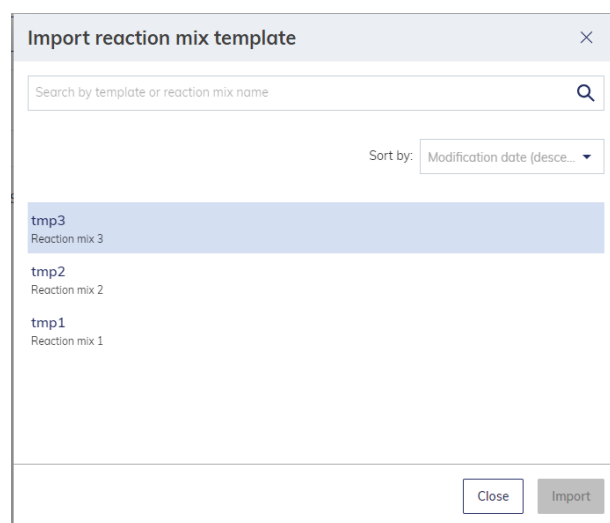

3. Select which reaction mix template should be imported.

Note: Reaction mix templates defined in the system can be searched by their names or reaction mix names defined inside the templates using the search field and sorted by template name, reaction mix name, modification and creation dates using the drop-down menu.

4. Click **Import**.

5. Reaction mix template is imported to a plate.

Note: In case a reaction mix name is already defined in a plate and the template with the same reaction mix name will be imported, the system will automatically add the suffix "Copy" for first copy and "Copy X" for the next copies, where X is the number of copies.

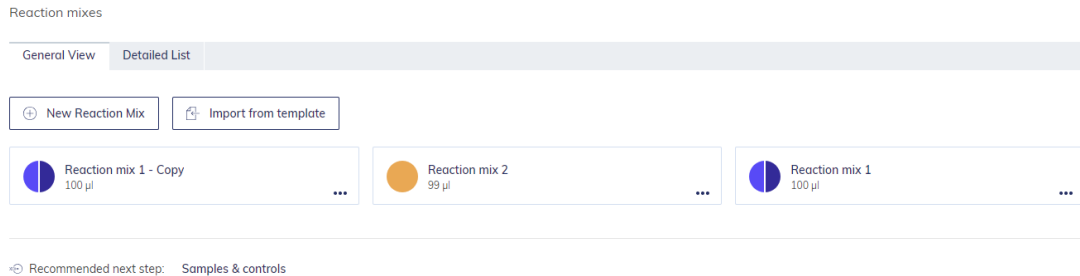

7.4.8. Defining samples, controls, and non-template controls

Samples

To add a new sample:

1. In the **Samples & control** tab, click **New Samples**.
2. The New Samples window appears.

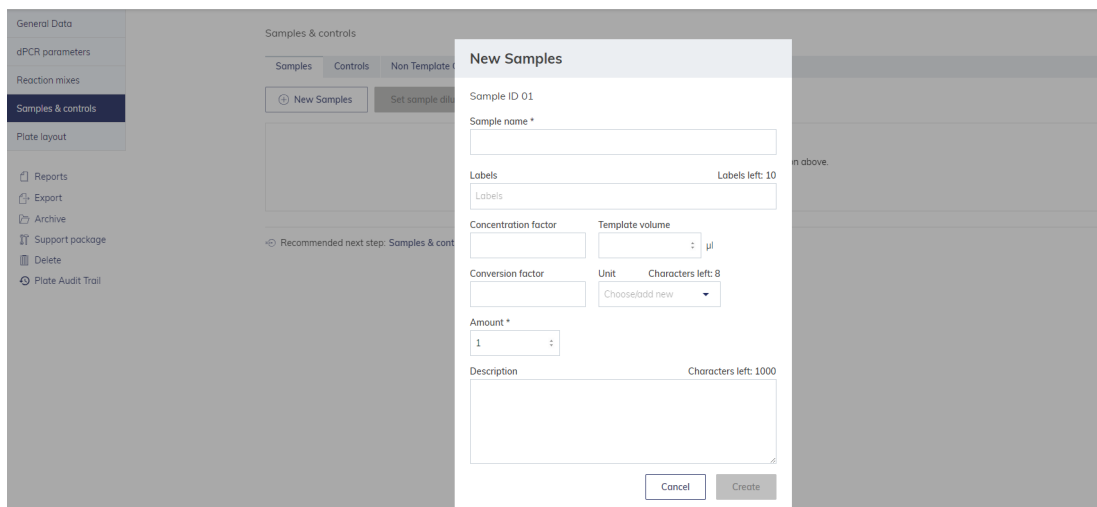

3. Enter the following information in the required fields:

- a. **Sample Name:** Enter the sample name. The name must be unique and must not contain any special characters. Up to 100 characters can be entered in this field.

Note: The Sample ID is automatically generated. This ID is unique for each sample created.

- b. **Labels:** Labels can be added to samples to assist in categorizing experiments.

c. **Optional:** To use the dilution calculation function during analysis, enter the sample template volume and if applicable a concentration factor. Refer to section "Dilution calculation option" for further details.

Note: The additional concentration factor for sample pre-dilution calculation can only be defined if the reaction mix dilution provided by the template volume is defined.

d. **Optional:** To use dilution calculation during analysis, enter the parameter Template Volume. Refer to section "Dilution calculation option" for further details.

e. **Optional:** To use the conversion function during analysis, enter the parameter Conversion factor and a corresponding conversion unit. A default available unit can be selected or a customized unit can be defined. Refer to section "Conversion factor" for further details.

f. **Amount:** Enter the number of samples that shall have the same sample name. They will be numbered automatically behind the sample name by adding 01, 02, 03, etc.

g. **Description:** Specify a description for your sample.

4. Click **Create**.

5. The sample(s) is/are added to the plate and can be used for each experiment.

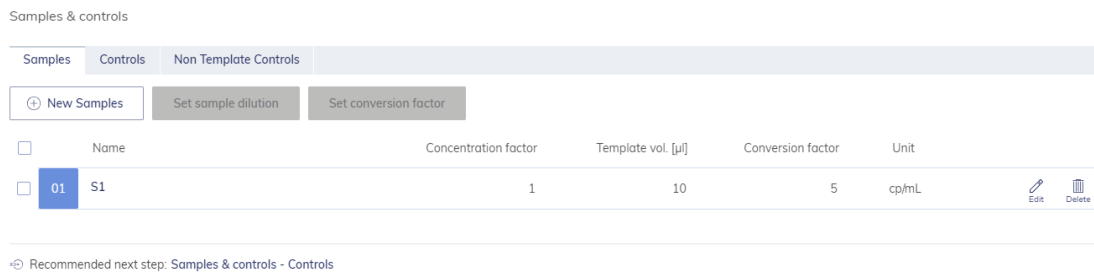

Recommended next step: Samples & controls - Controls

Note: A user can change the sample dilution or the conversion parameters for several samples at once by selecting the samples with the checkbox and using the buttons Set sample dilution and Set Conversion factor.

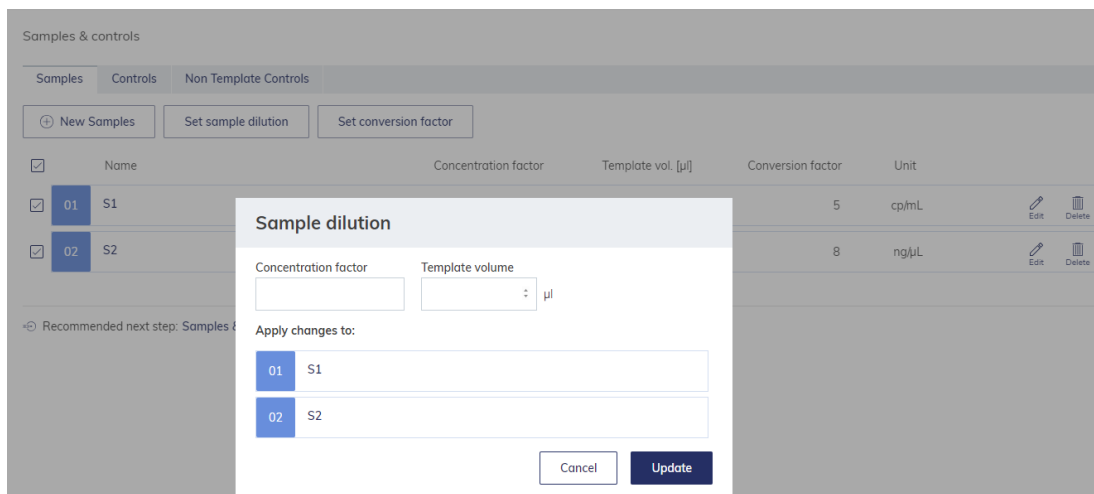

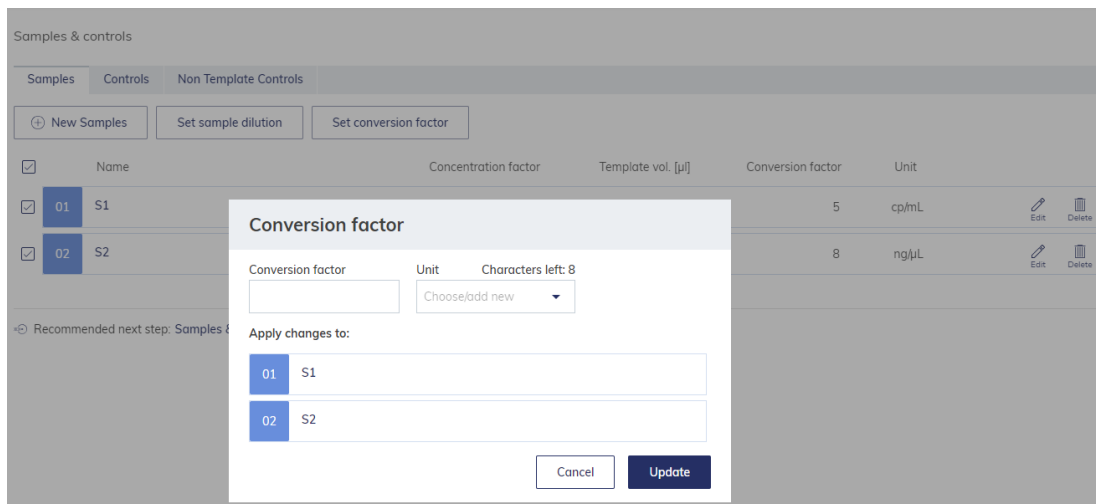

Controls

Adding positive or negative controls to your experiments is possible. To add controls:

1. Click the **Controls** tab.
2. Enter the name of your control in the “Control Name” field.
3. Click **Add Control**.
4. The control is added to your database and can be used for your experiment.

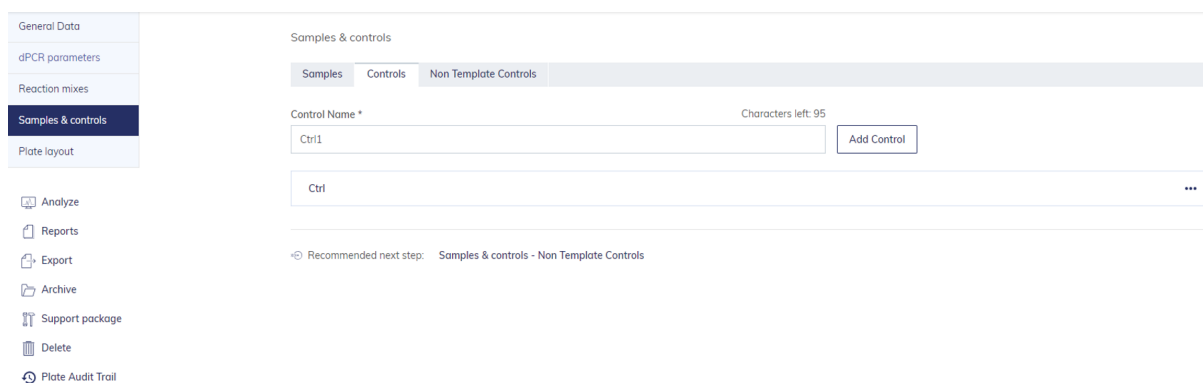

Note: For controls no dilution nor conversion information can be defined.

Non Template Controls

To add non template controls (NTC):

1. Click the **Non Template Controls** tab.
2. Specify the name of your non template control in the “Non Template Control Name” field.
3. Click **Add NTC**.

4. The non template control is added to the plate and can be used in the experiment.

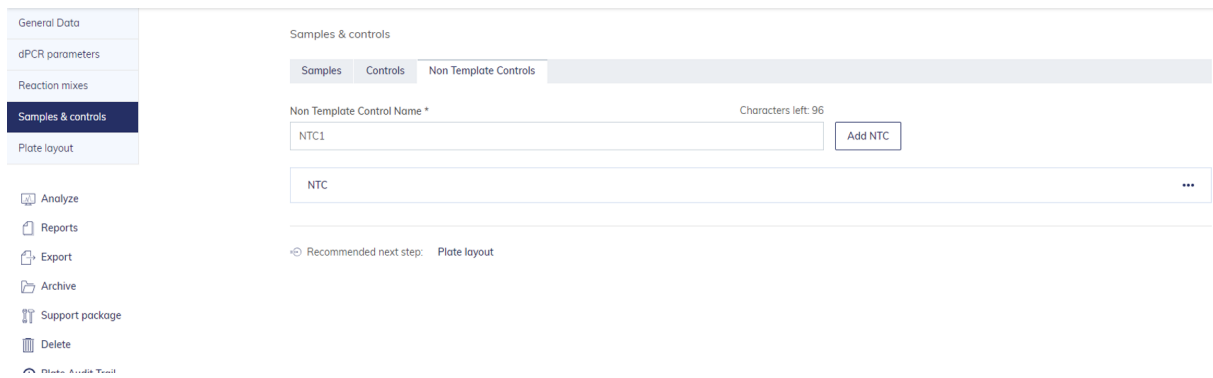

Note: For Non Template Controls, no dilution nor conversion information can be defined.

7.4.9. Defining plate layouts

Plate view

To define the plate layout, you must add reaction mix, samples, and controls to your plate.

Adding a reaction mix to the plate

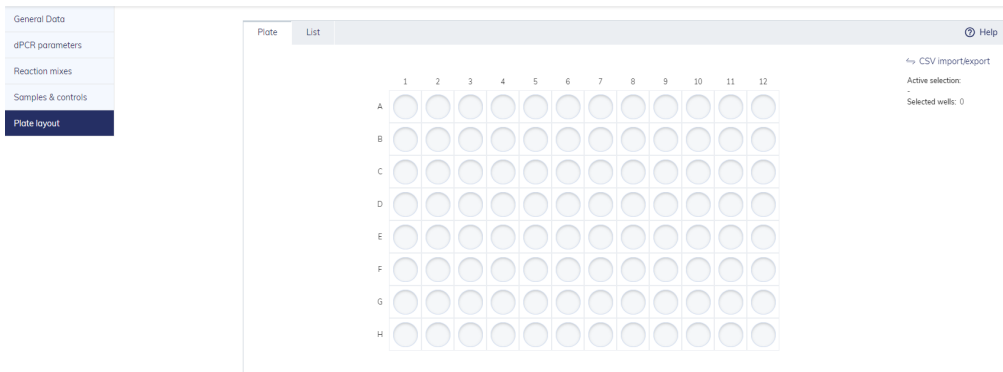

1. Left-click the desired well.
2. Left-click the **+** icon, then select **Add reaction mix** or **Mark as blank**. The Add reaction mix window appears.

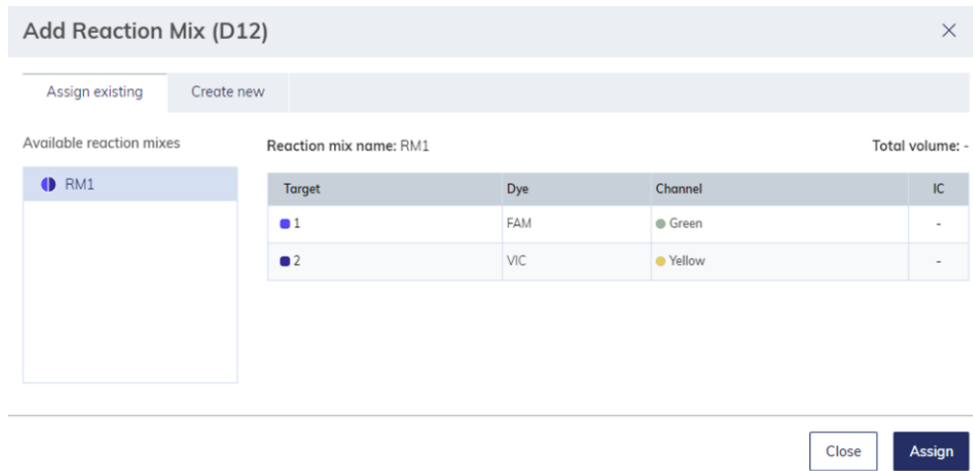

3. Select the reaction mix you want to add to the plate. To create a new reaction mix, click the **Create new** tab. See the "Creating new reaction mix" section for information about creating a new reaction mix.
4. Click **Assign** to add the reaction mix to the well.

Note: To edit or remove the reaction mix from the well, right-click the well and select **Edit reaction mix** or **Remove reaction mix**. User can also remove the reaction mix from the well by clicking the ... icon in the bottom right corner of well and select **Remove reaction mix**.

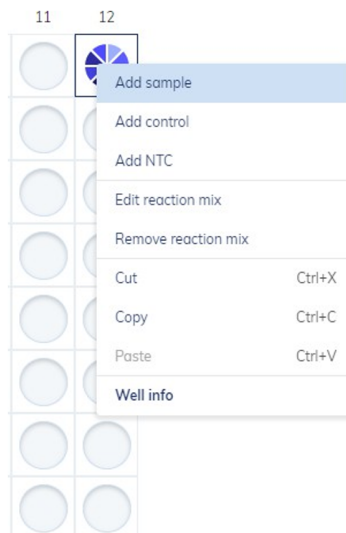

Adding samples to the plate

1. On a marked well, click the ... icon in the bottom right corner of a well or right-click the well.

Note: User can also mark more than one well if assigning a sample to multiple wells is desired.

2. Click **Add sample**.
3. The Add Sample window appears.

Add Sample (A1)

Assign existing | Create new

Select sample

S1

Description
my sample 1

Sample ID 01
Concentration factor 1
Template volume 10 µl
Conversion factor 5
Unit cp/mL

Labels
-

Close | Assign

4. Select a sample to add to the plate. To create a new sample, click the **Create new** tab. See Defining samples, controls, and non-template controls for information about creating new samples.
5. Click **Assign**.
6. The sample is added, and the well is marked with the Sample ID.



Note: To edit the sample or remove it from the well, right-click the well and click **Edit sample** or **Remove sample**. To remove the sample and the reaction mix from the well, select **Clear well**.

Adding controls to the plate

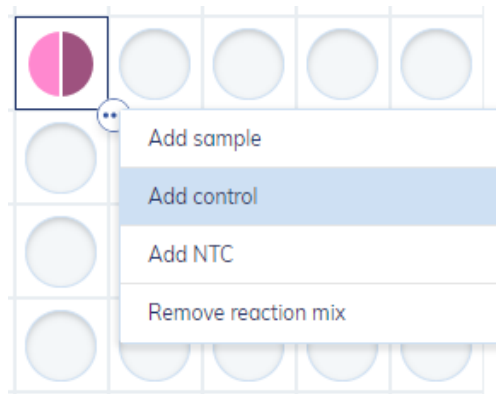

1. On a marked well, click ... icon in bottom right corner of well or right-click the well.
Note: User can also mark more than one well if assigning a control to multiple wells is desired.
2. Click **Add control**.
3. The Add Control window appears.

Add Control (D8) ✕

Control name *
Type in the name of a new control or select existing from the list...

Selected reaction mix	Target	Control Type	Dye	Channel
RM2	1 A5	Select	Cy5	Crimson
	2 A8	Select	-	Green
	3 -	-	-	-
	4 -	-	-	-
	5 -	-	-	-
	6 -	-	-	-
	7 -	-	-	-
	8 -	-	-	-

Close Assign

4. Select the control to be added to the plate from the list of controls or enter a new control name.
5. In the Control type list, select whether the control is positive or negative for the specific target.
6. Click **Assign**.
7. The control is added and the well is marked with a C.

Note: To edit or remove the control from the well, right-click the well and select **Edit control** or **Remove control**. User can also remove the control from the well by clicking the ... icon and selecting **Remove control**. To remove the control and the reaction mix from the well, select **Clear well**.

Adding NTCs to the plate

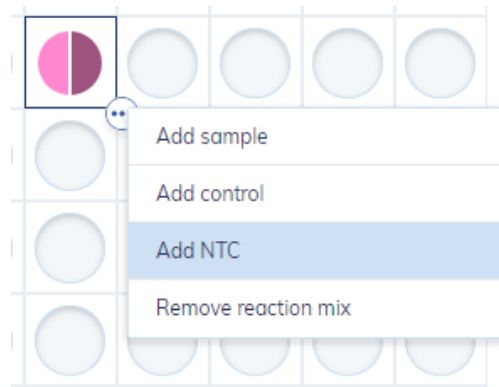

1. On a marked well, click the ... icon in bottom right corner of the well or right-click the well.
Note: User can also mark more than one well if assigning a non template control to multiple wells is desired.
2. Click **Add NTC**.
3. The Add Non Template Control window appears.

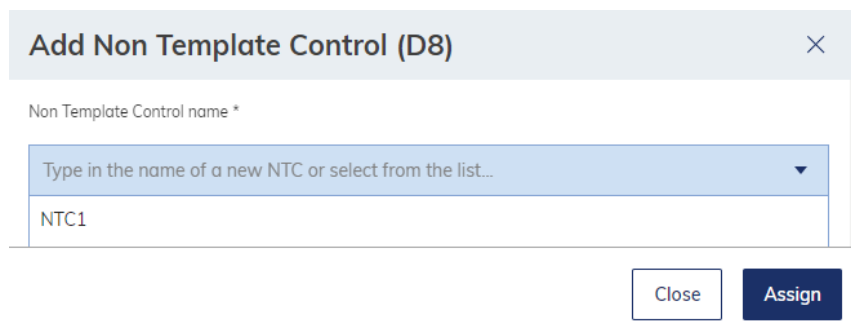

4. Select an existing non template control from the Non Template Control name list or enter a new name.
5. Click **Assign**.
6. The non template control is added and the well is marked with NTC.

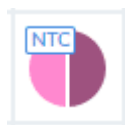

Note: To edit or remove the non template control from the well, right-click the well and select **Edit NTC** or **Remove NTC**. User can also remove the non template control from the well by clicking the ... icon and selecting **Remove NTC**. To remove the non template control and the reaction mix from the well, select **Clear well**.

Legend

User can click the **Help** icon in the upper right corner of plate layout area to display a legend and check the meaning of all icons and descriptions used on a plate layout.

Help

Well content

Sample ID Control NTC Non template control Internal control

Dilution information

- Reaction mix dilution**
 - Total volume for reaction mix is specified
 - Sample template volume is specified
- Full dilution information specified**
 - Total volume for reaction mix is specified
 - Sample template volume and concentration factor are specified
- Missing dilution information**
 - One of the following is missing:
 - Total volume for reaction mix
 - Sample template volume

Warnings / notifications

- Issue occurred, affecting marked well**
 - Hover over specific warning icon to get more details.

Close

Plate layout with defined gradient cycling

In case a gradient cycling is defined, the plate layout looks slightly different:

- Due to technical reasons and thermocycler design, the first and last rows of the plate (rows A & H) are disabled from usage and analysis. There is no possibility to add reaction mixes and samples or controls to wells from these rows.
- The assigned temperature gradient is displayed below the plate layout. The purpose of the temperature map is to present the temperatures applied in the wells.

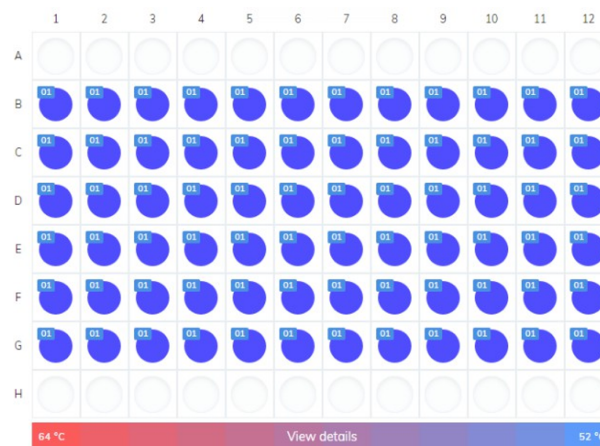

- With the help of the **View details** button, a temperature map is presented. By clicking **Download PNG**, the temperature map can be downloaded in *.png format.

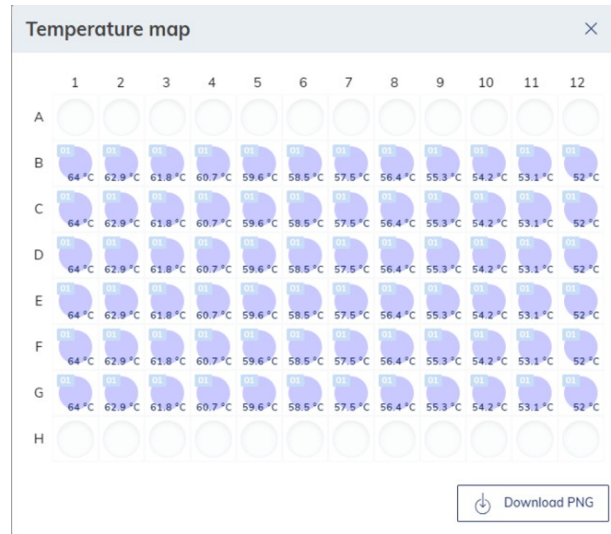

List view

The list view in the **Plate layout** tab displays a detailed overview of your plate setup.

Well	Sample/NTC/Control	Reaction mix	Target	Dye	Channel	IC
A1	-	-	-	-	-	-
A2	1ng gDNA	DPH218 ERBB2 + DPH186 TERT	DPH218 ERBB2 DPH186 TERT	FAM HEX	Green Yellow	-
A3	1ng gDNA	DPH218 ERBB2 + DPH186 TERT	DPH218 ERBB2 DPH186 TERT	FAM HEX	Green Yellow	-
A4	1ng gDNA	DPH218 ERBB2 + DPH186 TERT	DPH218 ERBB2 DPH186 TERT	FAM HEX	Green Yellow	-
A5	1ng gDNA	DPH218 ERBB2 + DPH186 TERT + DPH464 SPIN4	DPH218 ERBB2 DPH186 TERT DPH464 SPIN4	FAM HEX ROX	Green Yellow Red	-
A6	1ng gDNA	DPH218 ERBB2 + DPH186 TERT + DPH464 SPIN4	DPH218 ERBB2 DPH186 TERT DPH464 SPIN4	FAM HEX ROX	Green Yellow Red	-
A7	1ng gDNA	DPH218 ERBB2 + DPH186 TERT + DPH464 SPIN4	DPH218 ERBB2 DPH186 TERT DPH464 SPIN4	FAM HEX ROX	Green Yellow Red	-
A8	1ng gDNA	DPH43 AR + DPH536 AGO1 + DPH218 ERBB2	DPH43 AR DPH536 AGO1 DPH218 ERBB2	FAM HEX ROX	Green Yellow Red	-
A9	1ng gDNA	DPH43 AR + DPH536 AGO1 + DPH218 ERBB2	DPH43 AR DPH536 AGO1 DPH218 ERBB2	FAM HEX ROX	Green Yellow Red	-

You can modify this view by sorting and filtering:

1. Sort by rows or columns
2. Filter by existing reaction mixes
3. Hide specific columns

7.4.10. Plate layout: CSV import/export

It is possible to export plate data as CSV file. Click **CSV import/export**, then click **Export to CSV** to export the data.

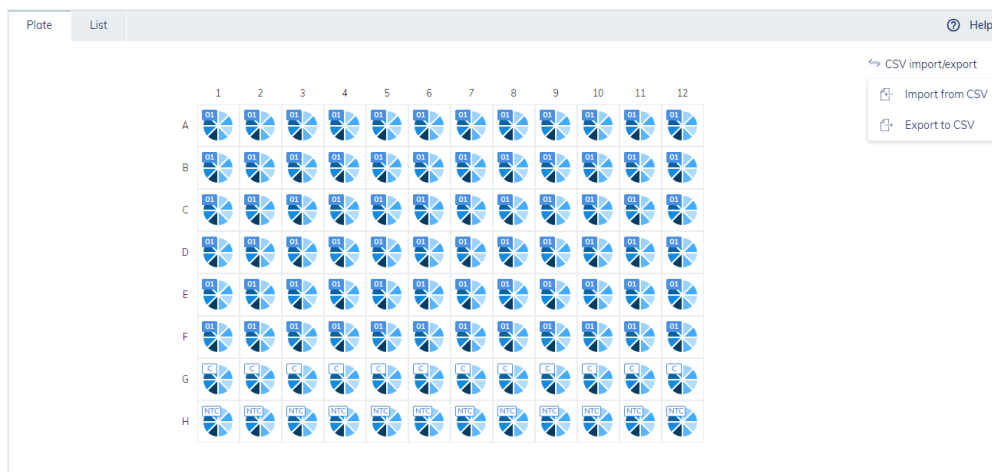

An import of the whole plate data from a CSV file is possible to define the plate layout. The file structure for import and export is identical. First, make sure that the plate was saved and shows Plate status: Defined before importing a CSV file. Click **CSV import/export** then click **Import from CSV**. A new window appears where you can upload the CSV file from the operating system.

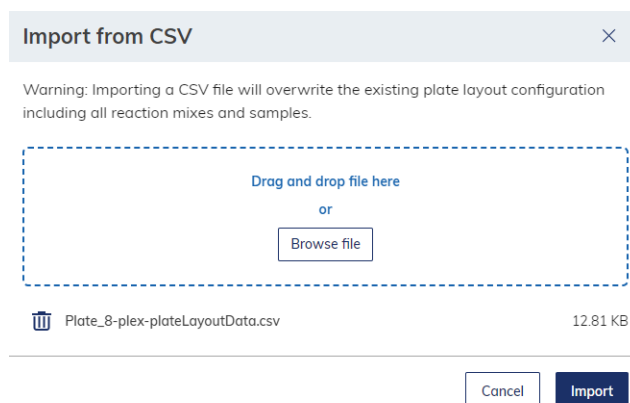

Note: All exported CSV files use a comma (",") as list separator and dot (".") as decimal separator and identical format is required for successful import of CSV files to QIAcuity Software Suite. Modification of CSV files with other software can overwrite separators due to regional settings, which can cause the following error.

CSV import failed due to data inconsistency in the CSV file. Please check the QIAcuity user manual for further information. 

To fix the problem please change the regional settings of your system.

CSV structure

1. The import and export CSV file looks the same and includes the following columns. Well – identifier of the well (A1, B1, etc.). This is a mandatory field.
2. Sample name – name of the sample.
3. **Type (Sample/NTC/Control)** – sample type – one of Sample/NTC/Control.

Note: Please pay attention to the exact notation of Sample, NTC, and Control. In case a sample name is added, this is a mandatory field.

4. **Template volume [µL]** – the value of sample template volume defined during sample creation.
5. **Concentration factor** – the value of the concentration factor defined during sample creation. In case a concentration factor is used, the template volume entry field is mandatory.
6. **Conversion factor** – the value of the conversion factor defined during sample creation.
7. **Conversion unit** – the unit of the conversion factor defined during sample creation. In case a conversion unit is added, this is mandatory field.
8. **Sample description** – the sample description added by a user during creation.
9. **Sample label** – the comma-separated labels assigned to a sample during creation.
10. **Reaction mix name** – the name of reaction mix.
11. **Total volume [µL]** – the value of the total reaction mix volume per well, defined during reaction mix creation. If case template volume is added, this is amandatory field.
12. **Channel 1–16** – up to 16 selected channels.

Note: Please pay attention to the exact notation of the channel names. All channels should be written in capitalized letters (e.g., GREEN, YELLOW, FAR RED, or for combinations, GREEN/YELLOW, etc.). All channels should be written in capitalized letters (e.g., GREEN, YELLOW, FAR RED, or for combinations, GREEN/YELLOW, etc.). When Amplitude multiplexing option is used, then suffixes notation is "(High)" and "(Low)"; for example, ORANGE/RED (High) can be used.

13. **Target 1–16** – up to 1 targets assigned to selected channels.
14. **Dye 1–16** – up to 16 dyes assigned to targets and channels. Please pay attention to the exact notation of dyes' names here. Only dyes that are available in the Software Suite can be used (see Table 2). When Amplitude multiplexing is enabled, the identical dye must be used for (High) and (Low) parts of the channel.

15. **Internal control 1–16** – up to 16 defined internal controls – if target or channel is set as internal control in Reaction Mix then the value should be set as TRUE, otherwise it should be set as FALSE.

Note: Please pay attention to the exact notation: TRUE or FALSE. This is a mandatory field, in case of master mix definition.

16. **Control type 1–16** – up to 16 defined controls – one of positive or negative – please pay attention to exact notation here—only lowercase letters are valid here. Control type should be filled only for Sample type: Controls (for NTC and Sample should be left empty). The value is set during adding Control to the well on plate layout. This is a mandatory field in case of control definition.

17. **CXTM Reaction mix template ID** – UUID of a reaction mix template with a custom cross talk matrix (CXTM), if the reaction mix with the customized cross talk matrix was assigned to the plate, this should be the same ID presented in the CXTM Details in the Reaction Mix pop-up window:

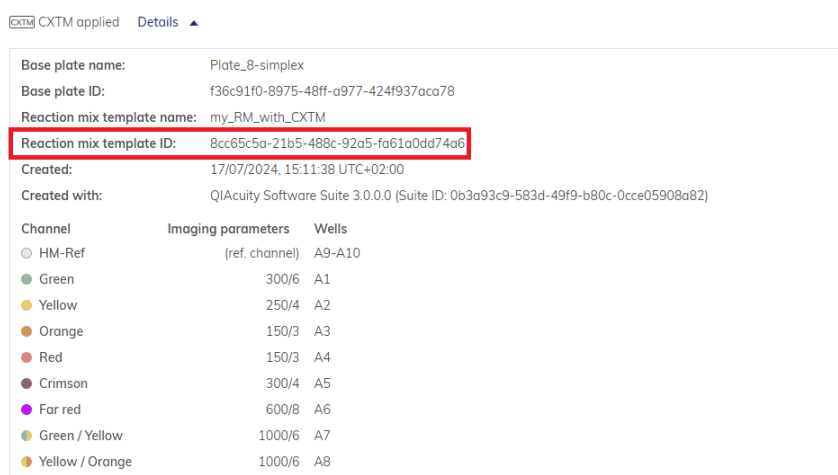

Important: In case the reaction mix with CXTM is used in a plate layout CSV a user should not fill the following field manually:

- Channel
- Dye
- Internal Control

These fields are automatically filled in based on the aforementioned CXTM Reaction mix template ID. Filling them in manually will cause the import to fail.

Import plate layout from CSV

Note that all data related to previously created plate layout elements, such as reaction mixes, samples, controls, etc.) will be overwritten after a CSV import.

A user can specify all plate parameters that are accessible via the user interface in applications. The software validates the input data and only data that exists in the application can be entered via the CSV file (e.g., only existing dyes can be entered).

Note: If a plate has defined a gradient cycling in the dPCR parameters, the application will display the warning pop-up window describing that rows A and H of the imported plate layout are going to be disabled.

In case of successful CSV import (there are no errors nor warnings in file), all data from the CSV file will be imported to the plate and the user will be notified by a message “CSV successfully imported” in bottom right corner:

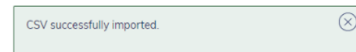
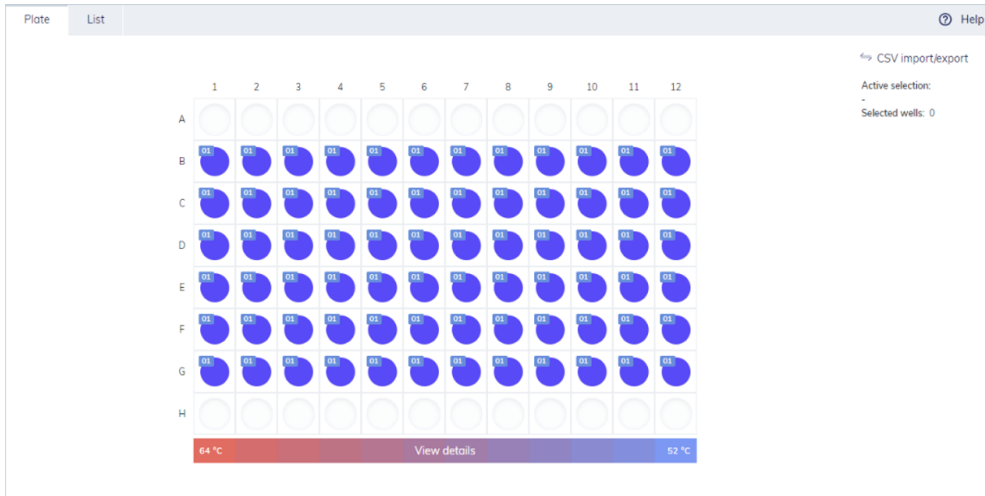

When will the CSV import function fail?

If there are some errors in the CSV file, there are two possible scenarios:

1. Data will be imported showing the warning that current plate data will be overwritten and the user will receive a notification with a list of issues:

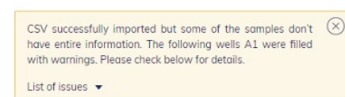
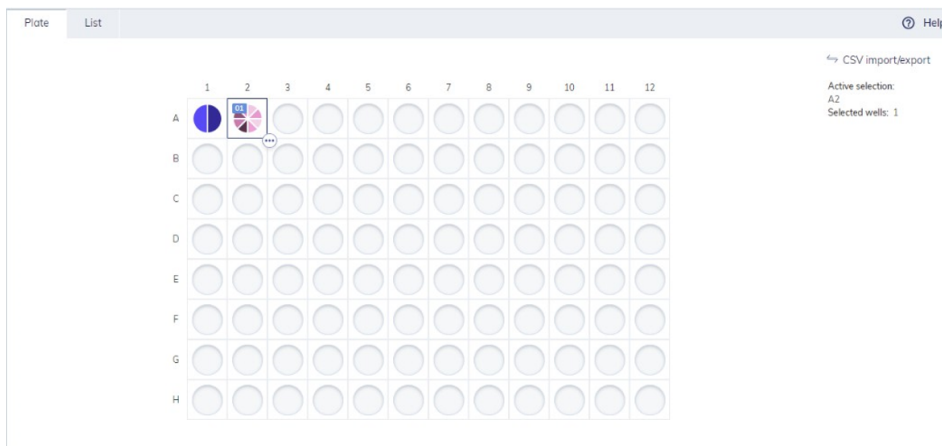

2. Data will not be imported, current data will not be overwritten, and the user will receive a notification with the error:

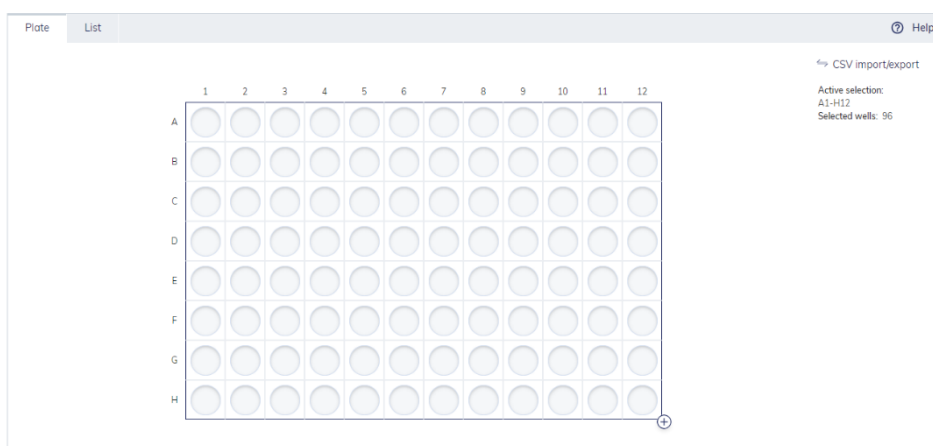

CSV import failed due to data inconsistency in the CSV file. Please check the QIAcuity user manual for further information.

Possible errors and warnings

Possible errors and warning related to reaction mixes, samples, and control in the CSV file are listed below:

1. Reaction mix:

a. Warning:

- Reaction mix name is null or empty.

b. Errors:

- Reaction mix name exceeds the limit of 100 characters or contain any special characters.
- Defined channel does not exist in the application.
- Defined dye does not exist in the application.
- CXTM Reaction mix template ID is filled in parallel with any of Channels, Dyes, and Internal controls.
- The same reaction mix has inconsistent (across CSV file):
 - Total volume
 - Amount of targets
 - Target names
 - Channel names
 - Different dyes
 - Value of internal control

2. Samples:

a. Warning:

- Sample name is null or empty.

b. Errors:

- Sample name exceeds the limit of 80 characters.
- The sample has a non-existing type assigned (the allowed types are sample, control, and non_template_control).
- The amount of labels exceed 10.
- The description exceeds the limit of 1000 characters.
- The template volume is empty while the concentration factor is filled.
- The concentration factor value is below 1 or exceeds 1,000,000,000,000.
- The template volume value is below 0.1 or exceeds 1000.
- The conversion factor value is below 0.000000001 or exceeds 1,000,000,000.0.
- The conversion unit exceeds the limit of 8 characters.
- The same sample has inconsistent (across CSV file):
 - Type
 - Concentration factor
 - Template volume
 - Labels
 - Descriptions

3. Control type

a. Errors:

- The field control types are filled, but the sample type is not "control".
- Not every target has a control type defined.

Additional warnings and errors related to particular features usage:

1. Long Stokes Shift (LSS) dyes and channels are used:

a. Errors:

- Reaction mix with more than 2 LSS is defined in CSV

2. CSV file contains reaction mix template with CXTM.

a. Errors:

- Reaction mix template with CXTM and template ID defined in CSV does not exist in the system.
- Reaction mix template with CXTM and template ID defined in CSV exists in the system, but:

- Target counts in CSV file differ from those in the reaction mix template.
- Any dye is defined.
- Any channel is defined.
- Any internal control is defined.

b. Warning:

- If some of the channels defined in CSV are not included in CXTM, CXTM is removed and a warning is added.

3. Amplitude multiplexing (AM) is applied.

a. Errors:

- Some of amplitude multiplexing channels are used more than once in CSV (e.g., GREEN (High) twice).
- Standard channels are mixed with AM channels within one channel (e.g., GREEN and GREEN (High) will result as error).

b. Warning:

- CXTM is removed and warning is added, when AM split is done (in CSV file) for different channels then standard ones used for CXTM (e.g., CXTM contains only Green and Yellow and in CSV AM split is done for different channel).

7.4.1.1. Managing your plates

To enter the Plates environment, click **Plates** in the main toolbar. Existing plates are shown in the Plates Overview window. Plates can be presented in grid view and list view accordingly.

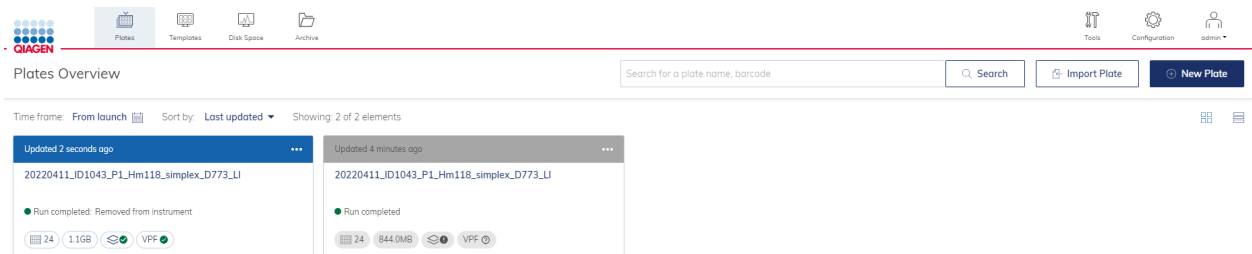

Plate Overview – grid view.

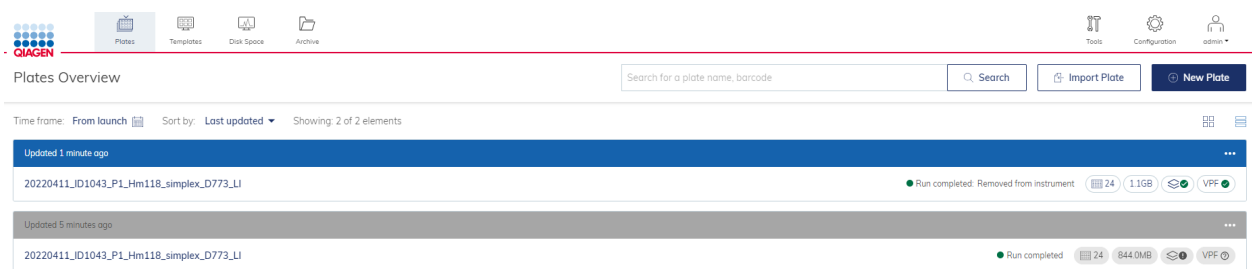
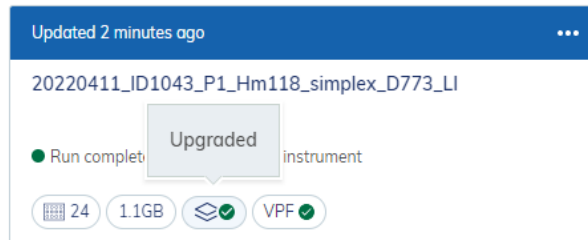

Plate Overview – list view.

As of QIAcuity Software Suite version 2.5, instead of “ – Upgraded” suffix in the plate name after an upgrade of a read-only plate, the color of bar and dedicated icons inform users if a plate is up to date or if an upgrade is required:

1. A blue bar is used to denote up-to-date plates, while a gray bar is used for read-only plates.
2. Plates that have been imported from older QIAcuity Software Suite version and are already upgraded display the following icon and tooltip message:



3. Plates that have been imported from older QIAcuity Software Suite version are not upgraded yet and remain in read-only mode display the following icon and tooltip message.



4. Plates created in the current QIAcuity Software Suite version do not display any of above icons and tooltip:

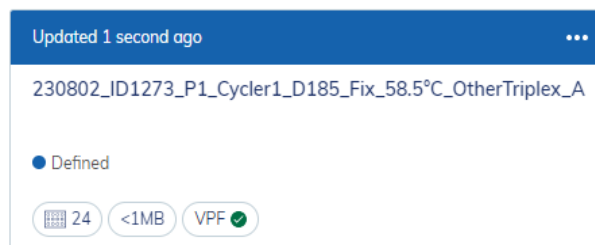

On the bar, information about the last update of a plate is shown. When a plate was updated less than an hour ago, minutes, or seconds are shown. When the plate was modified more than 24 hours ago, the date of the last modification is indicated.

The checkbox in the corner may be used to select or deselect plates manually. In addition, the **Select all** option can be used for bulk operations as described in section “Bulk plate archiving”.

Under the three dots menu (...) in the upper right corner, all actions that can be performed on a plate are listed. This includes upgrade, analyze, details, reports, export, archive/restore, and delete. Note that some actions are permissions dependent and not visible to users who do not have the relevant permissions.

Information icons

1. **Plate type icon** — The number 8, 24, or 96 indicates the plate type.
2. **Plate size icon** — This icon indicates the plate size on the hard drive.
3. **Plate status indicator** — On mouse hover, a tooltip message indicates if the plate is up-to-date or read only.
4. **VPF icon** — On mouse hover, a tooltip message indicates the status of the volume precision factor. Details can be found in section “Volume Precision Factor (VPF)”.
5. **Lock icon** — On mouse hover, a tooltip message shows the instrument ID and if a plate is locked by the instrument.

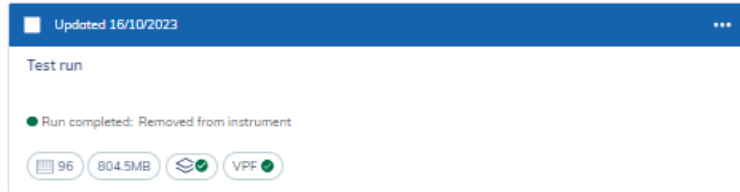

Example of up-to date plate (after upgrade), with VPF.



Example of read-only date plate without VPF.

Sorting

User can sort the Plates Overview window by Last updated, Plate name, or Plate status.

1. Click the symbol for file or list view to switch views within the Plates Overview window.

Note: Both views provide information regarding the plate name, plate status, modified date, type of plate, and used disk space.

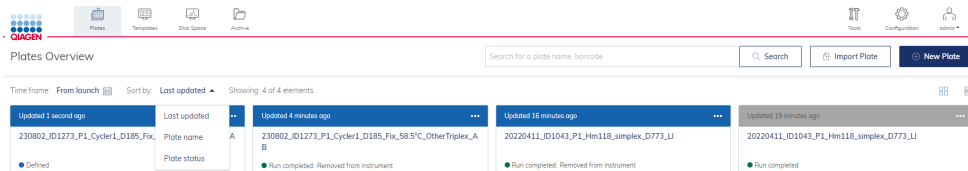

2. On a specific plate, click the ... button. The context menu provides options to edit, delete, or analyze the plate. It also points to the existing reports and enables the export of plates. When the selected plate is currently running, the run status and the respective plate details are visible.

Search

The plates overview screen provides search options for plates by providing the plate name or a barcode as search criteria. Use a combination of letters and enter it as a search string in the input field and click . The plates overview page is filtered and only plate names including the given letter combination are shown. The search functionality is not case sensitive. To get back from the search view to the general plates overview, either empty the search field and click or press **Esc** on a keyboard while the text field is active.

When searching for two keywords within a plate name, the search function can be simplified by using the % symbol in between search terms as a wild card. For example, the following plate name "Name_ID123456789_StudyABC_2023" can be found with the search function "Name%2023".



Filtering

Click the calendar symbol beside Time Frame to limit the overview results to plates modified within a specific time period. A window appears and enables selection or entry of a specific time frame. Click **Apply** to filter the results.

The screenshot shows a time frame filtering dialog box. It has four buttons for pre-defined filters: 'From launch', 'Last 7 days', 'This month', and 'Last year'. Below these buttons are two input fields labeled 'From' and 'To', each with a placeholder 'dd/MM/yyyy'. To the right of the input fields is a calendar for April 2023. The calendar shows the days of the week (M, T, W, T, F, S, S) and the dates from 1 to 30. At the bottom center of the dialog is an 'Apply' button.

Export and import plate data

To archive data and free-up disk space, plates can be exported as password-protected zip files. Click the respective plate in the plates overview. On the left side of the screen, click **Export plate**. The plate is exported as a password protected zip file.

Note: As of QIAcuity Software Suite version 3.0, there is no longer a limitation regarding the import and export of plates bigger than 2.5 GB.

After exporting and saving the password protected zip file, the plate can be deleted by clicking **Delete** on the left side of the screen. For more information about disk space, see the “Maintenance Procedures” section.

The screenshot shows a software interface for managing plates. On the left, there is a vertical menu with the following options: 'Plate layout' (highlighted), 'Analyze', 'Reports', 'Export', 'Archive', 'Support package', and 'Delete'. On the right, there is a form for editing a plate. The form has three main sections: 'Plate name *' with a text input field containing '210707_Test case 2_ID100_NTC_Q96LV_P2_MMx only_Suite VER_C92_AB - Copy' and a character count of 30; 'Plate type' with a dropdown menu set to 'Nanoplate 8.5K 96-well'; and 'Description' with a text area containing 'NTC: Q96LV: Fm002(Good Plates) Molding Lot: 002 Molding Date: 12/01/2024' and a character count of 1644.

To import a plate, click **Import Plate** in the plates overview.



A new window appears for upload of the password protected zip file. Click **Import** and the plate is added to the plates overview.

Note: A plate that already exists cannot be imported again.

Note: If a plate from a previous version is imported to a newer QIAcuity Software Suite version, it will be visible in read-only mode and must be upgraded before it can be edited. There is no possibility to import a plate from QIAcuity Software Suite versions earlier than 1.2.18. Exported plates from version 1.1.3 cannot be imported to version 3.0 directly. Therefore, import these plates into QIAcuity Software Suite version 1.2.18 prior to software update if the plate data are required for further analysis.

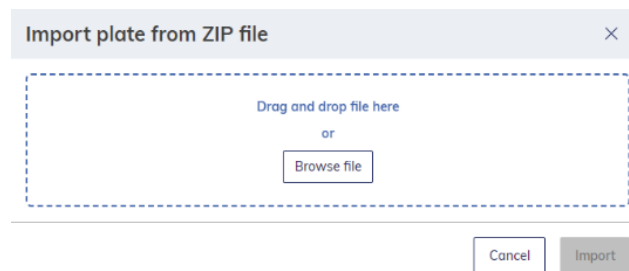

7.5. Setting up templates

There are two types of templates that can be used to set up experiments: plate template and reaction mix template. In both cases, user can create a new template of plate or reaction mix or use an existing plate or reaction mix and save it as template.

Note: Template creation is permission dependent.

7.5.1. Creating a new plate template

1. In the Main toolbar, click **Templates**, then select the **Plates** tab and click **New template**.



2. The Create New Plate Template window appears.
3. Enter the name for the template in the "Template name" field. User can enter up to 100 characters in this field. Click **Next**.
4. Follow the steps as described in the section "Setting up an experiment".
5. After entering all required information, click **Done** at the bottom of screen.
6. The template is stored in the database and can be used for future experiments.

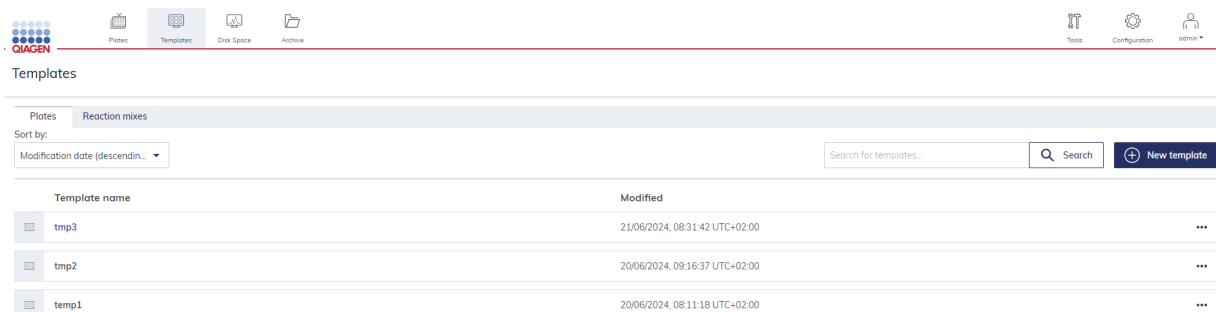

7.5.2. Saving existing plate as a plate template

Follow the steps to set up a new plate as described in section “Setting up an experiment”. After entering all required information, user can save the information as a template to use for future plates.

1. Click **Plate templates...** in the upper right corner of the screen.



Plate templates...

2. Click **Save as template**.

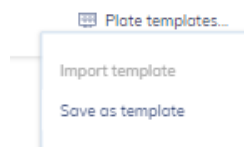

3. The Save as Plate Template window appears.
4. Enter the name of the template in the “Template name” field.

Note: Click **Already existing Plate Templates** to display an overview of the existing plate templates.

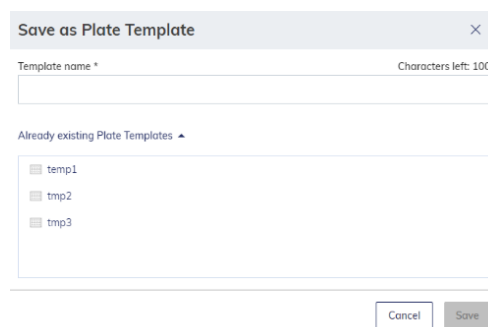

Save as Plate Template

Template name * Characters left: 100

Already existing Plate Templates ▲

- temp1
- tmp2
- tmp3

Cancel Save

7.5.3. Using a plate template to create a new plate

Existing templates can be used to create a new plate in two ways – from **New Plate** level and from the **Templates** level.

To use a plate template from the **New Plate** level:

1. In the Main toolbar, click **Plates**, then click **New Plate**.



2. Click **Plate templates**, then click **Import template**.

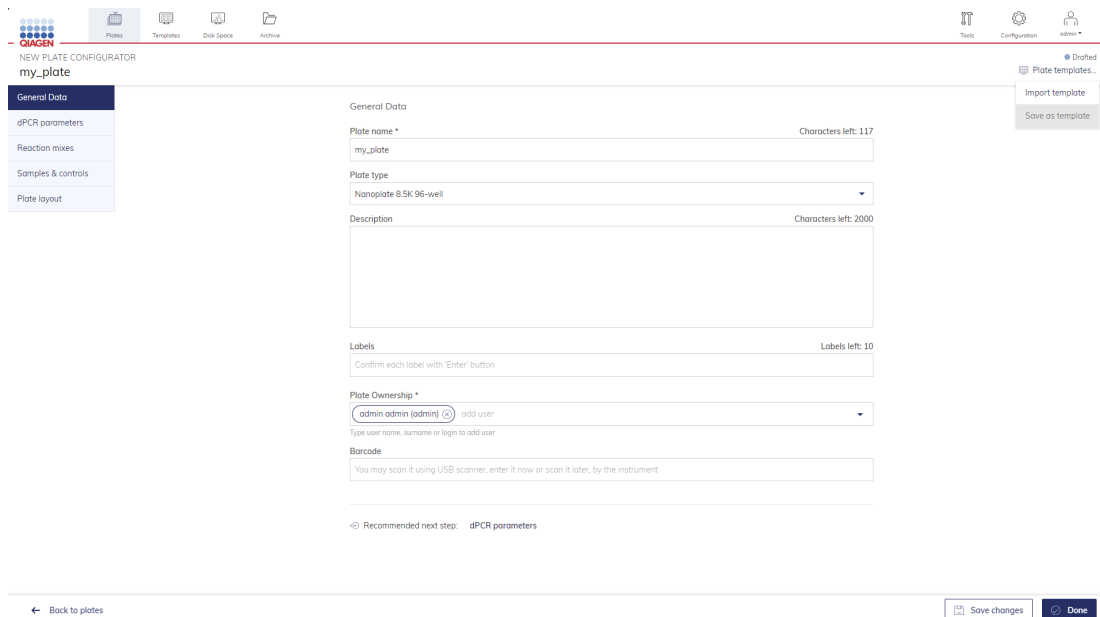

3. The Import Plate Template window appears with all existing templates.

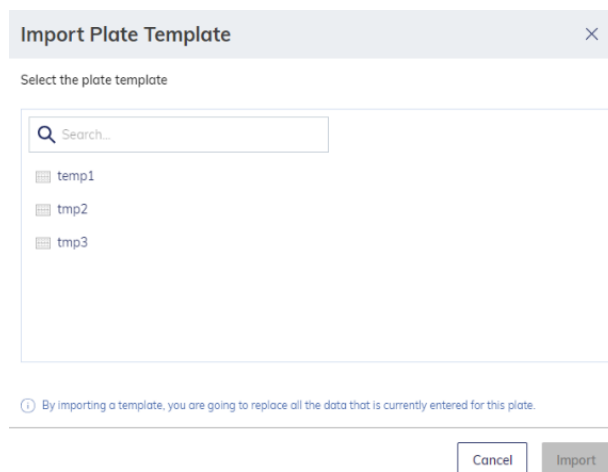

4. Select an existing template, then click **Import**.
5. All information in the selected template is automatically transferred to the new plate setup.

To use a plate template from the **Templates** level:

1. Go to **Templates**, then select the **Plates** tab.
2. Find the template to be used on the list then click the three-dot icon and select the option **Use in a new plate**.

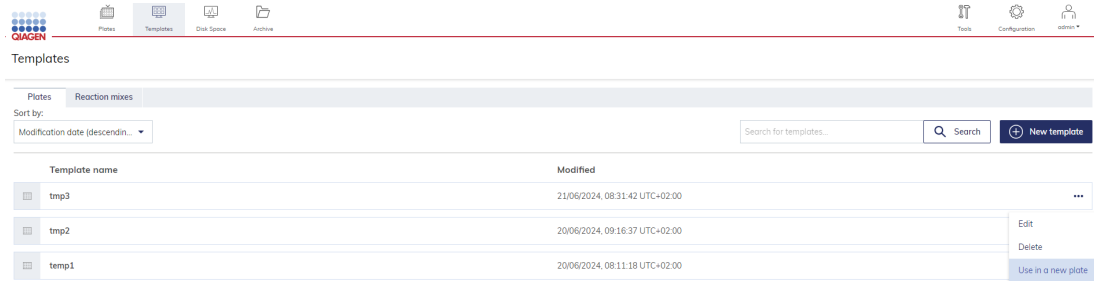

3. All information in the selected template is automatically transferred to the new plate setup.

7.5.4. Creating a new reaction mix template

1. In the Main toolbar, click **Templates**, then select the **Reaction mixes** tab and click **New template**.

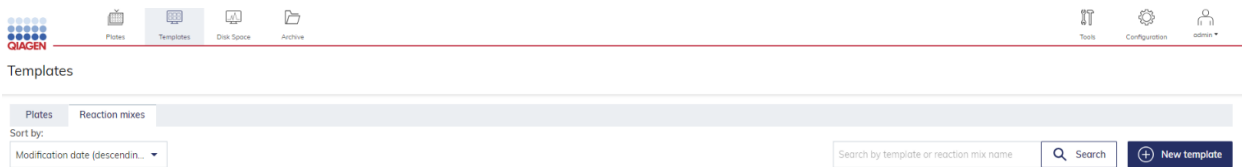

2. The New reaction mix template window appears.

The screenshot shows the 'New reaction mix template' dialog box. It has a title bar with a close button (X). The form contains the following fields and controls:

- Template name ***: A text input field with a character count of 'Characters left: 100'.
- Reaction mix name ***: A text input field with a character count of 'Characters left: 100'.
- Total volume**: A numeric input field with a unit selector (µl) and a 'Change color' button.
- Amplitude multiplexing**: A dropdown menu.
- Color**: A column of checkboxes.
- Target Name ***: A column of text input fields.
- Dye**: A column of dropdown menus.
- Channel(s) ***: A column of dropdown menus.
- Internal control**: A column of checkboxes.

At the bottom right, there are 'Cancel' and 'Create' buttons.

3. Enter the name for the template in the "Template name" field. Up to 100 characters are possible.
4. Follow the steps as described in the "Reaction mixes tab" section.

Example of template with 8-plex:

New reaction mix template
✕

Template name * Characters left: 86

Reaction mix name * Characters left: 97 Total volume

µl

Change color

Amplitude multiplexing ▼

Color	Target Name *	Dye	Channel(s) *	
■	<input style="width: 95%; border: 1px solid #ccc;" type="text" value="t1"/>	FAM	Green	<input type="checkbox"/> Internal control
■	<input style="width: 95%; border: 1px solid #ccc;" type="text" value="t2"/>	VIC	Yellow	<input type="checkbox"/> Internal control
■	<input style="width: 95%; border: 1px solid #ccc;" type="text" value="t3"/>	TAMRA	Orange	<input type="checkbox"/> Internal control
■	<input style="width: 95%; border: 1px solid #ccc;" type="text" value="t4"/>	ROX	Red	<input type="checkbox"/> Internal control
■	<input style="width: 95%; border: 1px solid #ccc;" type="text" value="t5"/>	Cy5	Crimson	<input type="checkbox"/> Internal control
■	<input style="width: 95%; border: 1px solid #ccc;" type="text" value="t6"/>	Cy 5.5	Far red	<input type="checkbox"/> Internal control
■	<input style="width: 95%; border: 1px solid #ccc;" type="text" value="t7"/>	LSS G/Y	Green / Yellow	<input type="checkbox"/> Internal control
■	<input style="width: 95%; border: 1px solid #ccc;" type="text" value="t8"/>	LSS Y/O	Yellow / Orange	<input type="checkbox"/> Internal control

Example of template with 8-plex and activated amplitude multiplexing for channel Green:

New reaction mix template

Template name * Characters left: 78
 my_RM_template_with_AM

Warning (1)

ⓘ When selecting Amplitude Multiplexing, please ensure that High-Multiplexing-Reference channel in imaging parameters is enabled.

Reaction mix name * Characters left: 97 Total volume 100 µl
 RM2

Amplitude multiplexing ▲

Select all Green Yellow Orange Red Crimson Far red Green / Yellow
 Yellow / Orange Orange / Red Red / Crimson Crimson / Far red

Color	Target Name *	Dye	Channel(s) *	Internal control
Green	t1_low	SYBR Green	Green (Low)	<input type="checkbox"/>
Green	t1_high	SYBR Green	Green (High)	<input type="checkbox"/>
Yellow	t2	VIC	Yellow	<input type="checkbox"/>
Orange	t3	TAMRA	Orange	<input type="checkbox"/>
Red	t4	Texas Red	Red	<input type="checkbox"/>
Crimson	t5	Quasar 680	Crimson	<input type="checkbox"/>
Far red	t6	Cy 5.5	Far red	<input type="checkbox"/>

- After entering all required information, click the **Create** button.
- The template is stored in the database and can be used for future experiments.

Note: Creating reaction mix templates from an existing reaction mix or from reaction mix templates is described in sections “Saving reaction mixes as templates” and “Importing reaction mixes from templates”, accordingly.

Templates

Plates Reaction mixes

Sort by: Modification date (descendin...)

Search by template or reaction mix name

Template name	Reaction mix name	CXTM ⓘ	Modified by	Last modification
rmix-template	RM1	-	admin	21/06/2024, 14:04:09 UTC+02:00

Note: The CXTM (Custom Cross Talk Matrix) column indicates whether reaction mix template has a custom cross talk matrix assigned to it. If CXTM is assigned, the CXTM column displays **Yes** with a check mark icon. Please refer to the section “Custom cross talk matrix” for more details.



7.5.5. Managing your templates

To enter the Templates environment, click **Templates** from the Main toolbar. The overview screen lists all existing templates for plates and reaction mixes on separate tabs.

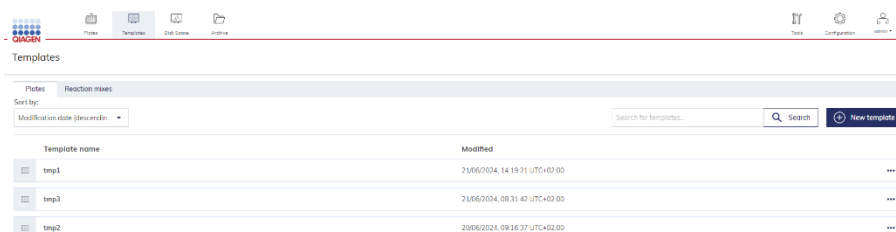

On the desired template, click the ... button to open a context menu that provides the following options:

- Edit, delete, or use the template in a new plate – for any of the “Plates” templates
- View details/edit or delete the template – or any of the “Reaction mixes” template

Note: There is no possibility to download or export a plate template. However, it is possible to export a plate, import it into another Software Suite instance and generate a new plate template from this plate.

Sorting

User can sort the Templates Overview window by modification date or name. Sorting the templates by the modification date enables user to view the recently modified entries.

The template list can be sorted by:

- Modification date (ascending or descending) or template name (ascending or descending) – for plate templates
- Template name (A-Z), reaction mix name (A-Z), reaction mix name (A-Z) with CXTM first, modification date (descending), creation date (ascending or descending) – for reaction mixes templates

Filtering

Searching for specific templates can be done by entering the template name (or reaction mix name for reaction mixes templates) in the Search field.

New template

See the section “Setting up templates” to create a new templates.

7.6. Analysis

The QIAcuity Software Suite analysis of plates that have been processed by the instrument. The following analysis options are available in the software:

1. Absolute Quantification
2. Mutation Detection
3. Genome Editing
4. Copy Number Variation
5. Gene Expression

7.6.1. Accessing the analysis environment

To access the Plate Analysis environment:

1. On the Plates Overview page of the Plates environment, search for the plate for analysis. Alternatively, you can open the Plate Analysis environment. Click the plate name in the Plates overview, then select **Analyze** from the context menu.

Note: The plate run must be completed.

2. Click the ... icon in the upper right corner of the plate tile.



3. Select **Analyze** from the context menu.

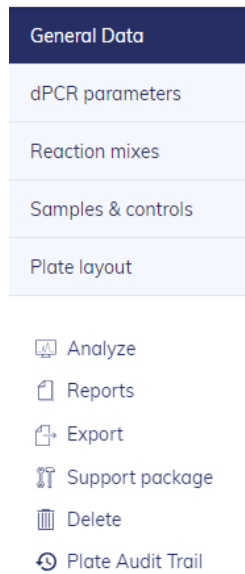

7.6.2. Plates after QIAcuity Software Suite version upgrade

After upgrading the QIAcuity Software Suite (see “Installation Procedure” and “Upgrading the QIAcuity Software Suite to a newer version” sections), the status of all plates will be changed to Read-only until the plates are upgraded to the new software version. The same applies to plates that are imported from a previous Software Suite version. Read-only plates can be recognized by gray bar on top of the plate tile and a dedicated icon with a tooltip displaying “Read-only plate”:



Note: After upgrade, the original plate becomes read only. This means that the results of the experiment are in read-only mode and user is not able to change the threshold anymore (threshold can be changed only on an up-to-date plate, upgraded, or created in current software version).

To upgrade a plate, go to the plate tile in the plates overview and click the ... menu, then select the **Upgrade** option from the drop-down menu. Alternatively, click the plate name in the tile to enter the plate configurator view, then click **Upgrade** in the context menu.

Note: If upgrading QIAcuity Software Suite an older version using indirect scenarios (e.g., upgrade from version 1.2.18), it is not recommended to upgrade plates in intermediate versions – one final upgrade in the desired version (e.g., 3.0) is adequate.

During the plate upgrade, a blue pulse indicator is shown on the plate tiles, indicating the upgrade process is taking place. During the upgrade process, both plates are blocked and cannot be accessed and changed to avoid inconsistent data or loss of data.

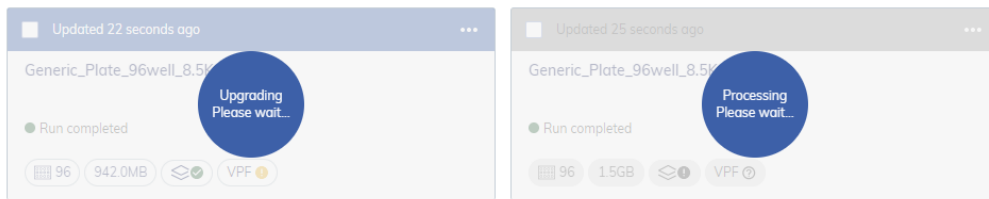

If the plate has been upgraded successfully, two plates will be displayed: the original (read-only) plate that includes the previously performed analysis, and the upgraded version of the plate. Up-to-date plate (the upgraded version of the original one) can be recognized by: the same name, a blue bar on top of the plate tile, and a dedicated icon with a tooltip displaying "Upgraded":

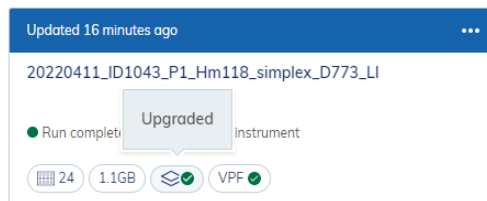

User can redirect from the read-only plate to the general data section of the upgraded plate by clicking ... menu and selecting the option **Go to upgraded plate** or from the analysis level (of Read-only plate) using the **Go to upgraded plate** button on dedicated communicate:

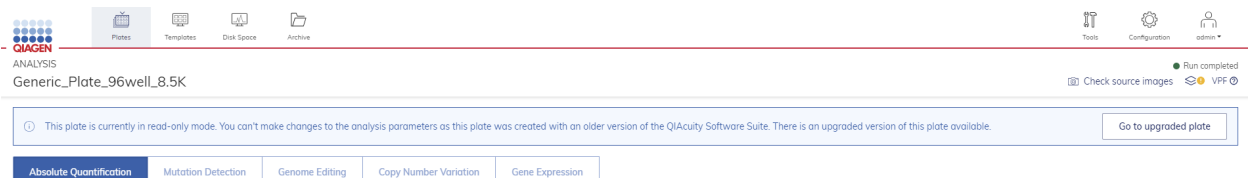
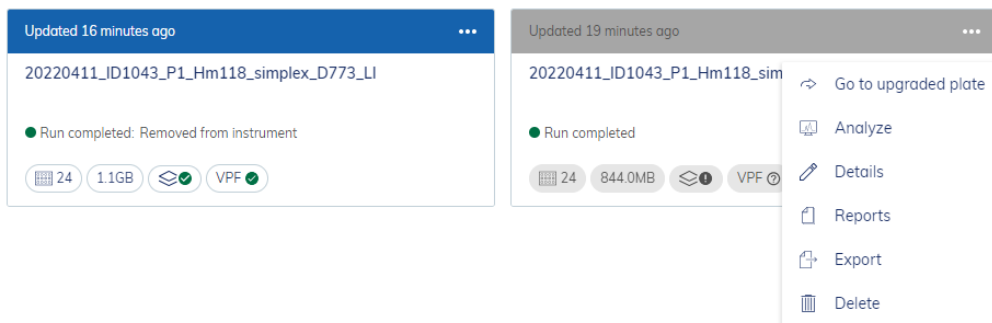

7.6.3. Volume Precision Factor (VPF)

The Volume Precision Factor (VPF) offers a unique feature to secure consistency in precision of concentration results obtained from a QIAcuity dPCR run. In general, Nanoplates provide partitions of fixed sizes that enable a very precise calculation of sample concentration. Potential variation of partition sizes in Nanoplate batches, caused by different stampers (molding form for microstructures), can be addressed by applying the stamper-specific VPF. The VPF specifies the exact cycled volume of a well within a Nanoplate and therefore further increases precision of concentration calculation in each well. If a VPF is not available for a particular Nanoplate batch, concentrations are calculated using an average cycled volume per plate until the VPF is imported. The microstructure molding form is defined by the first two digits of the plate barcode.

Note: Multiple plate batches can come from one microstructure molding form.

New sets of VPFs will be published during production of the Nanoplate batches and can be downloaded from the QIAGEN website.

Identification of VPF status on plates

In general, there are three possible states of the VPF on a plate:

1. **VPF applied** — VPF is already applied to plate, and it will be taken into account during concentration calculation.
2. **VPF not applied** — VPF is not applied to plate, and it will not be taken into account during concentration calculation. Plates without VPF will be analyzed using an average volume per plate.
3. **VPF unknown** — This is reserved for Read-only plates originating from older versions of the Software Suite, where software cannot deduct if VPF was applied or not. During plate upgrade, described in section “Plates after QIAcuity Software Suite version upgrade”, the system will assign VPF, if available. VPF status and plate status display the following icon combinations on the plate overview:

Plate status/VPF status	Applied	Not applied	Unknown
Up to date (from current Software Suite version)			N/A
Read-only	N/A		
Upgraded			N/A

In addition, information about missing VPF is available on:

1. Plates Overview screen

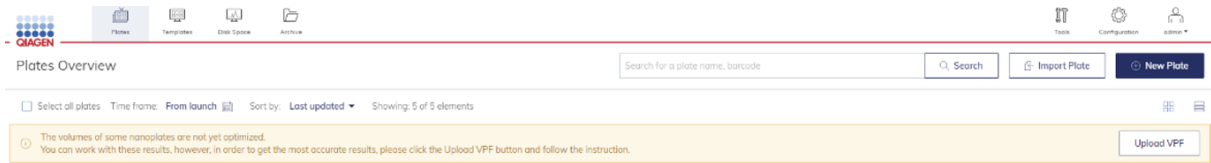

2. Analysis screen

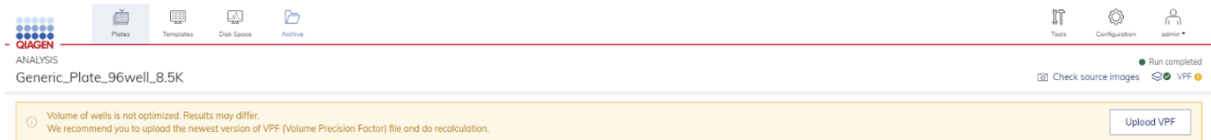

3. Plate Configuration screen

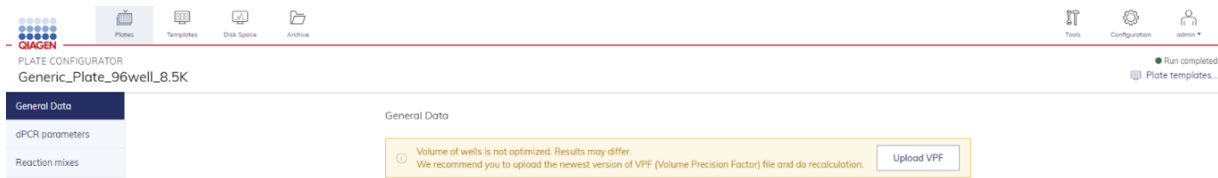

4. Report

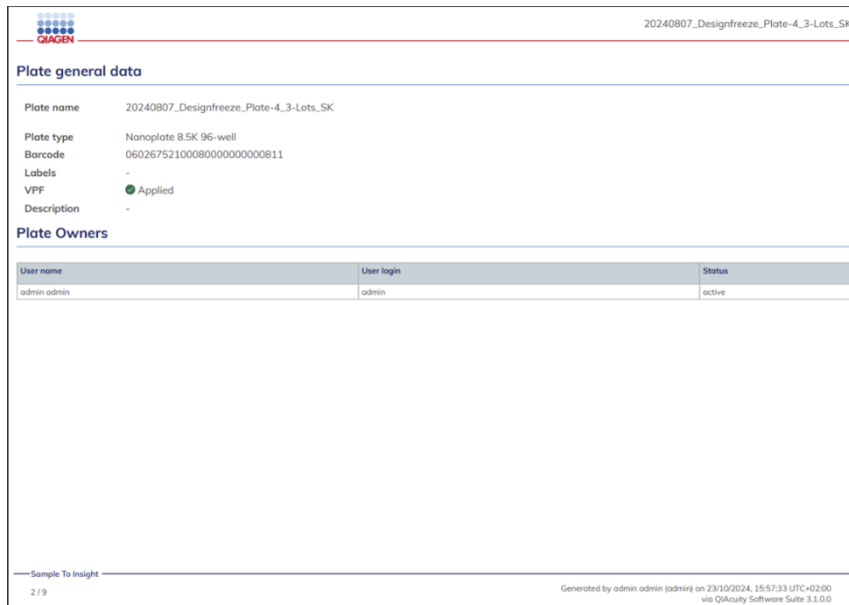

Loading VPF

All existing VPFs to all used microstructure negative forms are bundled together in one zip file to allow the user to always download the most recent version. After uploading the file, the QIAcuity Software Suite automatically chooses which VPFs are missing and applies them. To load the most recent VPF, user can either click the **VPF** icon of the plate or directly click the **Upload VPF** button on the Plates Overview screen, Analysis screen, or on the Plate Configuration screen.

After uploading the file, the QIAcuity Software Suite automatically chooses which VPFs are missing and applies them. To load the most recent VPF, click the **Upload VPF** button on the Plates Overview screen, Analysis screen, or on the Plate Configuration screen. Once clicked, a new pop-up window will appear with detailed instruction. Follow the steps to properly load the most recent VPF file:

Upload Volume Precision Factor (VPF) ⓧ

The Volume Precision Factor (VPF) specifies the exact volume of a nanoplate of a specific batch providing most accurate concentration results. If a VPF is not available for a new nanoplate batch, concentrations are calculated using an average volume per plate until the VPF is downloaded.

- 1 Go to <https://resources.qiagen.com/qiacuity-vpf>
or as alternative
Go to www.qiagen.com
Select:
Products > Instruments & Automation > PCR Instruments > QIAcuity Digital PCR System > Product Resources > Operating Software
- 2 Download VPF file to your desktop or external disk
- 3 Upload the downloaded zip file here

Choose a file or drag it here

Cancel Save

Note: The structure of the VPF file is a password-protected .zip file. IT should be loaded in its .zip form and should not be unzipped.

Note: New VPFs are valid for the whole system. When loaded, the QIAcuity Software Suite will refresh all plates and align concentrations using the newly loaded well-based volumes. The notifications about missing VPF for applicable plates will no longer be shown. All new imported plates and plates restored from the Archive will automatically receive the VPF assignment.

7.6.4. Custom cross talk matrix

To compensate the spectral overlap between the fluorescent dyes called cross talk, a correction algorithm is implemented for the six standard channels (Green, Yellow, Orange, Red, Crimson, Far red) in the QIAcuity Software Suite. This standard cross talk matrix is automatically applied to experiments using above mentioned standard channels and no additional actions are required from the users.

In experiments, where any of the high multiplex channel combinations are activated for imaging, a dedicated custom cross talk matrix (CXTM) could be prepared for result optimization. The following five channel combinations are available for multiplexing:

- Green/Yellow
- Yellow/Orange
- Orange/Red
- Red/Crimson
- Crimson/Far red

A notification is provided about required custom cross talk matrix for if additional multiplex channel combinations are configured during imaging settings for a plate.

Channel	Exposure duration	Gain
<input checked="" type="checkbox"/> Green	300 ms	6
<input checked="" type="checkbox"/> Yellow	250 ms	4
Channels available for high multiplex instruments only		
<input checked="" type="checkbox"/> Orange	150 ms	3
<input checked="" type="checkbox"/> Red	150 ms	3
<input checked="" type="checkbox"/> Crimson	300 ms	4
<input checked="" type="checkbox"/> Far red	600 ms	8
<input checked="" type="checkbox"/> Green / Yellow	1000 ms	6
<input type="checkbox"/> Select channel	ms	

The creation of a custom cross talk matrix is not limited to the multiplex channel combinations only, but can be created for any desired channel usage. If, for example, the default matrix is creating artifacts affecting setting threshold, a custom cross talk matrix can be also created for any standard channel/s.

Custom cross talk matrix can be created from two channels up to eight channels. There is no limit to the number of custom cross talk matrixes that can be generated.

For using amplitude multiplexing mode, the custom cross talk matrix needs to be created for the standard channels and/or channel combinations, and afterwards, the reaction mix needs to be edited to enable amplitude multiplexing.

Preparing custom cross talk matrix (CXTM)

For creation of a custom cross talk matrix (CXTM), a dedicated plate needs to be created. This plate must exhibit all targets of interest (from one up to eight targets) as individual simplexes. For example, if a custom cross talk matrix is desired for a triplex reaction mix, all three individual targets must be available as simplexes on one dedicated plate. Wells containing no template controls (reaction mix only) are also required on the same plate. The plate used to create the CXTM can also contain the desired multiplex reaction so that the results can be checked directly. The dedicated CXTM plate should be processed as usual and afterwards the CXTM configurator can be opened.

Note: While setting Imaging on the plate, the reference channel must also be taken into consideration. To use the High-Multiplexing Reference channel in experiments along with the custom cross talk matrix, the High-Multiplex reference channel should be enabled for the training plate. In addition, all simplexes should exhibit the identical High-Multiplex reference. In general, all simplexes and the reference wells (exhibiting reaction mix only without template) should exhibit the identical reference. There is no mixture of standard and High-Multiplex reference allowed.

Important: Preparing a custom cross talk matrix is permission dependent. The following permissions are required to trigger the CXTM configurator: Create Custom Cross Talk Matrix, Create template, Read all/owned plates.

Important: To trigger the CXTM configurator on a plate, the following conditions must be met:

- The plate must be upgraded (no read-only plates).
- The plate layout needs to be defined, with at least one well per target exhibiting a simplex reaction mix for the desired target and at least one well that exhibits reaction mix only without any target.

Note: Amplitude multiplexing usage is not feasible for custom cross talk matrix creation. The targets need to be assigned to normal channels or channel combinations, without enabling amplitude multiplexing mode.

- Plate must have results (experiment in status "finished") for all dedicated reaction mixes.

Note: Optimal results for the custom cross talk matrix will strongly depend on the quality of experimental results in the CXTM training plate. The user who prepares the CXTM training plate should:

1. Minimize the number of invalid partitions for each channel.
2. Assure there are no warnings (e.g., saturation problems) in the training plate.
3. Assure there are approximately 25–75% of positive partitions per Nanoplate well per simplex reaction.
4. Ensure that the same assays are used in the actual experiments as were used on the CXTM plate.

To finally prepare custom cross talk matrix user should follow below procedure:

1. The CXTM configurator can be triggered from any dedicated plate in the plate overview or during analysis. In the plates overview environment, plates that fulfil the pre-requisites for CXTM creation, exhibit the "create CXTM" function under the three-dot menu:

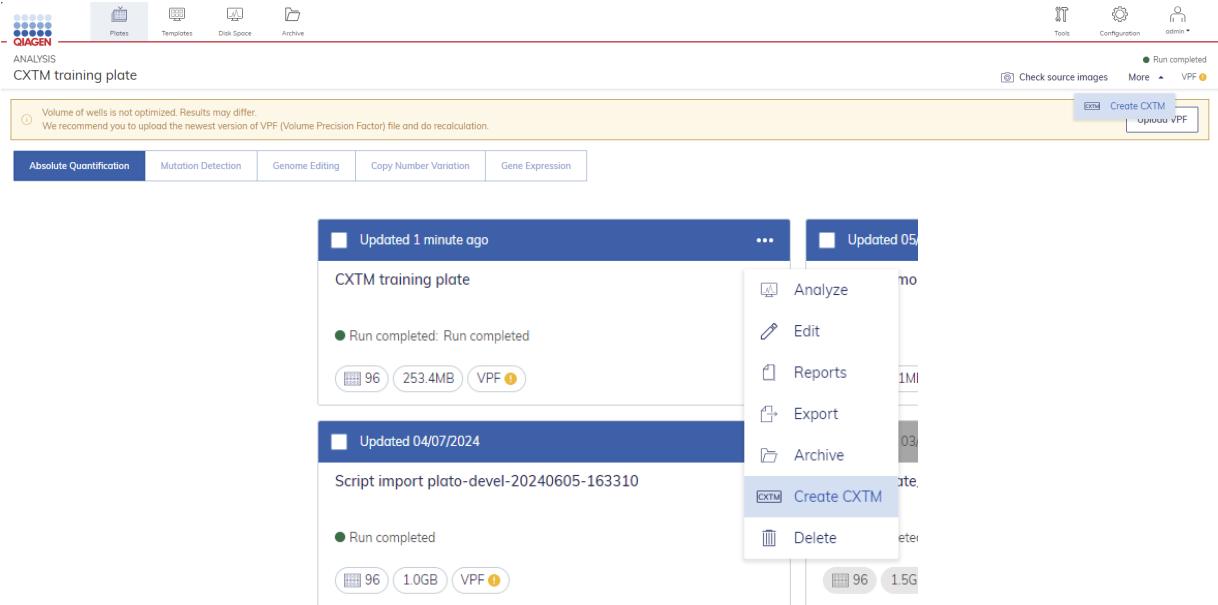

To start the CXTM creation during analysis, click **More** and select **Create CXTM**.

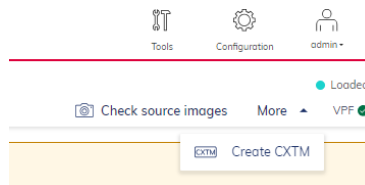

2. After selecting the option **Create CXTM**, user is guided to the CXTM configurator automatically. The configurator consists of four steps:

Important: While working with the CXTM configurator, do not log out manually nor let automatic system log off occur to avoid lost progress. User must always start over in the configurator if logged out mid-session.

- a. **Reference channel** – This is the first step, where non-template control reaction mix only wells are selected within the chosen imaging step in the plate layout and are then assigned to CXTM.

Under plate layout, a list with detected reference channels for the selected wells is displayed. In case of mixed scenarios, user should select the appropriate one, depending on the desired CXTM. High-Multiplexing-Reference not only is always required for more than 6-plex experiments but also can be used optionally for other user scenarios, as described in the section "Imaging tab. At least one well exhibiting reference channel must be selected.

At this step, all wells that are not suitable for selection are automatically disabled. This includes wells containing targets, wells without images, wells with missing reference channels, and wells with different type of references than the one already selected.

After selecting wells with the proper reference channel type, click the **Add to CXTM** button.

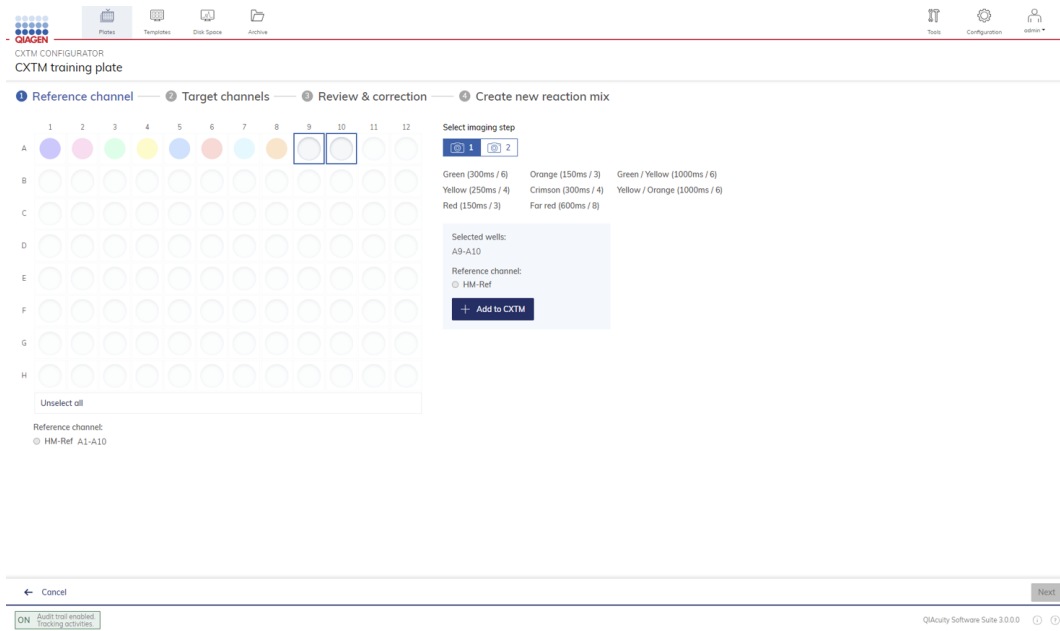

After adding wells to the custom cross talk matrix, an information table containing Channel, Target, wells, and reference type selected is presented.

Custom cross talk matrix

Channel	Target	Wells
<input type="radio"/> Reference	-	A9-A10 <input type="radio"/> HM-Ref

In case of wrong selection, user can remove it using the **trash** icon.

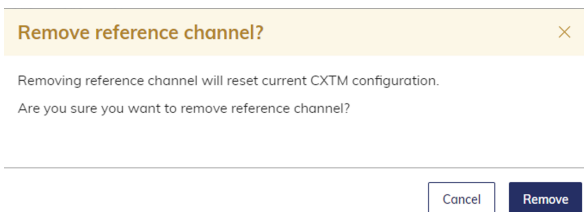

After reference channel is added correctly to CXTM, click the **Next** button at the bottom of screen.

- b. **Target channels** – In this step, select and assign wells exhibiting the targets/channels that should be used for CXTM creation. Click appropriate well/s and then on **Add to CXT matrix**.

Wells that are not suitable to be selected are automatically disabled. This includes blank and empty wells, wells with multiple targets, wells without images, wells with missing reference channels, and wells with different type of reference than selected in the first step of the configurator.

Add all desired channels/targets in this step as there is no possibility to add them later nor to update the custom cross talk matrix. While adding one simplex, wells with other simplexes remain inactive. Hover with the mouse over

the wells to view a tooltip with information about Sample, NTC, or Control. After selecting well(s), a panel on the right side presents information about well(s) and selected target & channel.

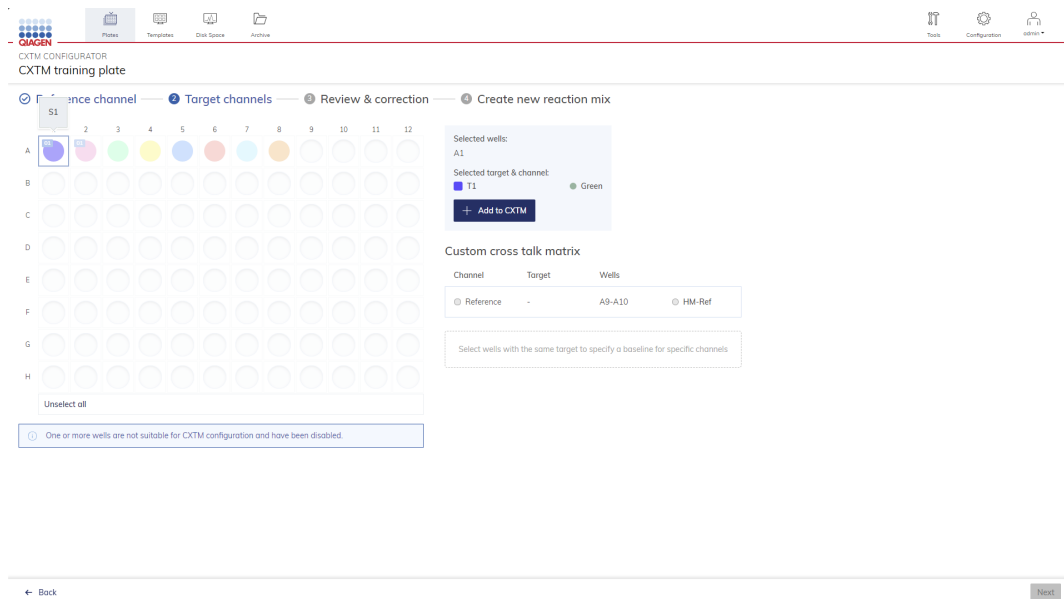

When all desired targets/channel of interest are added, click **Next** to continue.

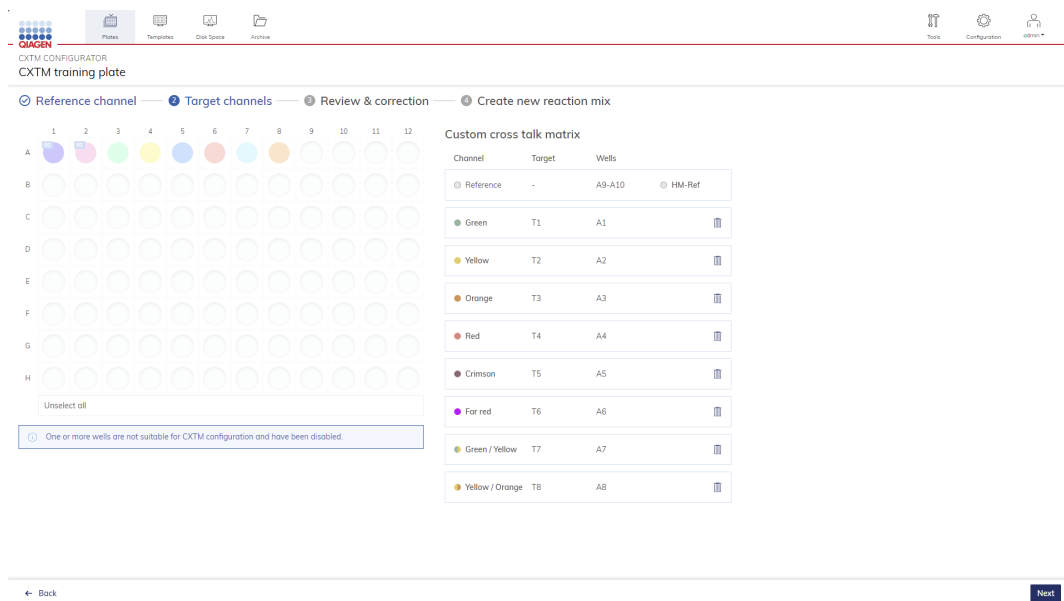

- c. **Review & correction** – In this step, user saves the created custom cross talk matrix along with new reaction mix template. Enter a Template and Reaction mix name (see further detail under Creating a new reaction mix template “ section). The plots do not exhibit any cross talk correction that is usually visible on regular 1D Scatterplots during Analysis (exhibiting default cross talk matrix for the standard channels). If required, the thresholds for particular well exhibit the simplex reactions can be adjusted.

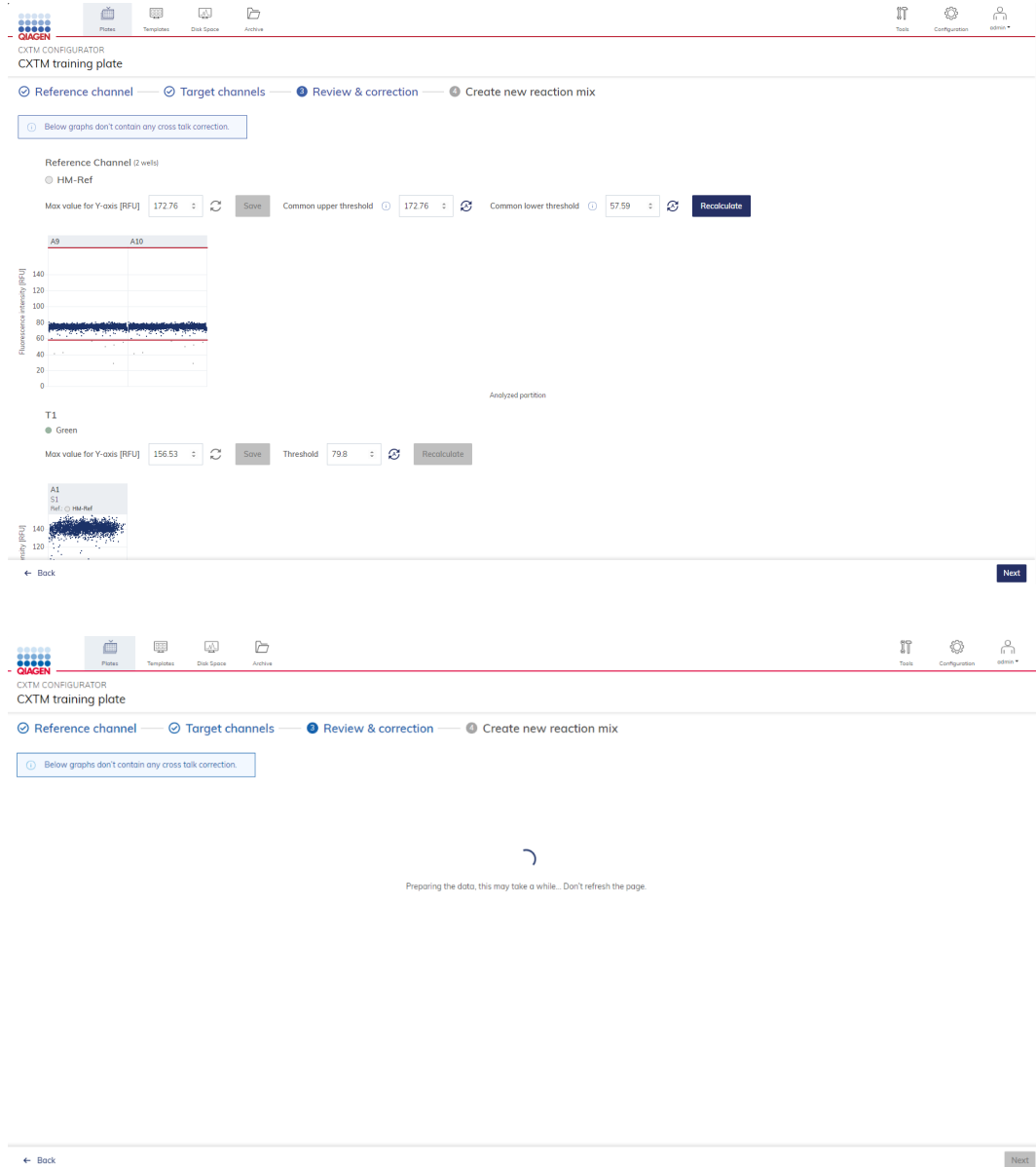

After all threshold corrections are done, press the **Next** button at the bottom of the screen to go to the last step.

- d. **Create new reaction mix** – In this step, user save created custom cross talk matrix along with new reaction mix template. Similarly like for regular Reaction mix template user needs to input Template name and Reaction mix name as mandatory. Optionally, user can define Total volume parameter and change the color. In section below, there is a list of targets that user defined in step 2 of configurator. User can change names of the targets, select used dyes and assign internal control for each channel. To save CXTM along with Reaction Mix template user press the **Save** button at the bottom of screen.

Note: User cannot apply Amplitude multiplexing here; it can be applied later after saving template.

Important: Calculated cross talk strictly depends on dyes thus dyes selected here cannot be changed later from Reaction mix template edition level.

Color	Target Name *	Dye	Channel(s) *	Internal control
■	T1	FAM	Green	<input type="checkbox"/>
■	T2	VIC	Yellow	<input type="checkbox"/>
■	T3	TAMRA	Orange	<input type="checkbox"/>
■	T4	ROX	Red	<input type="checkbox"/>
■	T5	Cy5	Crimson	<input type="checkbox"/>
■	T6	Cy 5.5	Far red	<input type="checkbox"/>
■	T7	LSS GY	Green / Yellow	<input type="checkbox"/>
■	T8	LSS YD	Yellow / Orange	<input type="checkbox"/>

After successful saving of CXTM an information message at the top of screen appears and the plate configurator is closed.

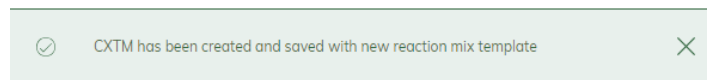

Usage of custom cross talk matrix

All available reaction mixes templates are listed template list:

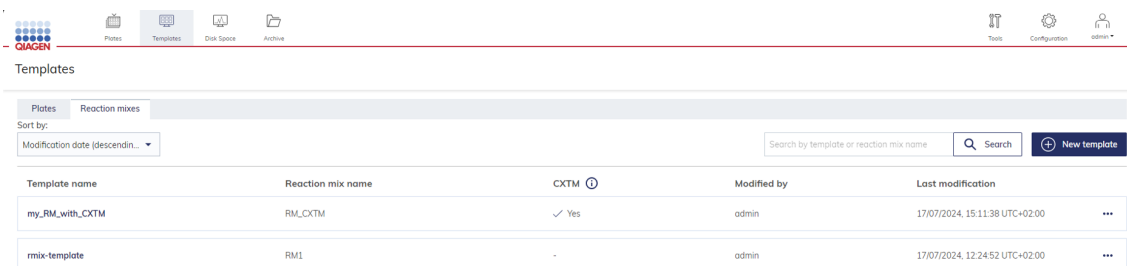

The screenshot shows the 'Templates' section of the QIAGEN software. It features a navigation bar with 'Plates', 'Templates', 'Disk Space', and 'Archive'. Below the navigation bar, there are tabs for 'Plates' and 'Reaction mixes'. A 'Sort by' dropdown is set to 'Modification date (descendin...'. A search bar contains the text 'Search by template or reaction mix name' and a 'Search' button. A 'New template' button is also visible. The main content is a table with the following data:

Template name	Reaction mix name	CXTM	Modified by	Last modification
my_RM_with_CXTM	RM_CXTM	✓ Yes	admin	17/07/2024, 15:11:38 UTC+02:00
rmix-template	RM1	-	admin	17/07/2024, 12:24:52 UTC+02:00

After user with sufficient permission, click the three-dot icon and select **Details/Edit** option. Edit reaction mix template modal is presented.

Additional CXTM section applied with expandable details is presented. After expanding user is presented with details of cross talk matrix:

- **Base plate name** – name of the plate that was used to prepare matrix in CXTM configurator
- **Base plate ID** – UUID of above plate
- **Reaction mix template name** – name of reaction mix template given in CXTM configurator
- **Reaction mix template ID** – UUID of above reaction mix template
- **Created** – date of creation of reaction mix template
- **Created with** – QIAcuity Software Suite version and UUID used for creation of above reaction mix template
- **Channel – Imaging parameters – Wells** – set of wells and their parameters used to prepare matrix in CXTM configurator

Edit reaction mix template ✕

<input type="checkbox"/>	<input type="text" value="T3"/>	<input type="text" value="TAMRA"/>	<input type="text" value="Orange"/>	<input type="checkbox"/>
<input type="checkbox"/>	<input type="text" value="T4"/>	<input type="text" value="ROX"/>	<input type="text" value="Red"/>	<input type="checkbox"/>
<input type="checkbox"/>	<input type="text" value="T5"/>	<input type="text" value="Cy5"/>	<input type="text" value="Crimson"/>	<input type="checkbox"/>
<input type="checkbox"/>	<input type="text" value="T6"/>	<input type="text" value="Cy 5.5"/>	<input type="text" value="Far red"/>	<input type="checkbox"/>
<input type="checkbox"/>	<input type="text" value="T7"/>	<input type="text" value="LSS G/Y"/>	<input type="text" value="Green / Yellow"/>	<input type="checkbox"/>
<input type="checkbox"/>	<input type="text" value="T8"/>	<input type="text" value="LSS Y/O"/>	<input type="text" value="Yellow / Orange"/>	<input type="checkbox"/>

CXTM CXTM applied Details ▲

Base plate name: Plate_8-simplex
Base plate ID: f36c91f0-8975-48ff-a977-424f937aca78
Reaction mix template name: my_RM_with_CXTM
Reaction mix template ID: 8cc65c5a-21b5-488c-92a5-fa61a0dd74a6
Created: 17/07/2024, 15:11:38 UTC+02:00
Created with: QIAcuity Software Suite 3.0.0.0 (Suite ID: 0b3a93c9-583d-49f9-b80c-0cce05908a82)

Channel	Imaging parameters	Wells
<input type="radio"/> HM-Ref	(ref. channel)	A9-A10
<input checked="" type="radio"/> Green	300/6	A1
<input checked="" type="radio"/> Yellow	250/4	A2
<input checked="" type="radio"/> Orange	150/3	A3
<input checked="" type="radio"/> Red	150/3	A4
<input checked="" type="radio"/> Crimson	300/4	A5
<input checked="" type="radio"/> Far red	600/8	A6
<input checked="" type="radio"/> Green / Yellow	1000/6	A7
<input checked="" type="radio"/> Yellow / Orange	1000/6	A8

While editing reaction mix template, user can modify the following content:

- Change Template name
- Change Reaction mix name
- Change Total volume
- Change Color
- Change Targets names
- Apply the **Amplitude multiplexing** option for any channel/s included in the custom cross talk matrix

Other modifications are blocked to assure that CXTM is always consistent with reaction mix template and will not be detached. Changes are applied directly after clicking the **Update** button on modal.

Edit reaction mix template ✕

Amplitude multiplexing ▲

Select all
 Green
 Yellow
 Orange
 Red
 Crimson
 Far red
 Green / Yellow
 Yellow / Orange
 Orange / Red
 Red / Crimson
 Crimson / Far red

CXTM applied Details ▲

Base plate name: 8plex_TC1_2_96LV_C96_HK

Base plate ID: d4023aa0-8855-4612-859d-a6543b680151

Reaction mix template name: my_RM_with_CXTM

Reaction mix template ID: 3e6a9fdd-1f93-4b4a-9f03-f6756902aacc

Created: 25/10/2024, 11:46:43 UTC+02:00

Created with: QIAcuity Software Suite 3.1.0.0 (Suite ID: 6babe810-3b9d-49f6-9f26-69d381fd50a4)

Channel	Imaging parameters	Wells
○ HM-Ref	(ref. channel)	A11, B11, C11, D11, E11, F11, G11, H11
● Green	300/6	A1, B1, C1, D1, E1, F1, G1, H1
● Yellow	250/4	A2, B2, C2, D2, E2, F2, G2, H2
● Orange	150/3	A3, B3, C3, D3, E3, F3, G3, H3
● Red	150/3	A4, B4, C4, D4, E4, F4, G4, H4
● Crimson	300/4	A5, B5, C5, D5, E5, F5, G5, H5
● Far red	1000/8	A6, B6, C6, D6, E6, F6, G6, H6
● Green / Yellow	1000/6	A7, B7, C7, D7, E7, F7, G7, H7
● Orange / Red	400/4	A8, B8, C8, D8, E8, F8, G8, H8

Color	Target Name *	Dye	Channel(s) *	<input type="checkbox"/> Internal control
■	<input type="text" value="T1L"/>	FAM	Green (Low)	<input type="checkbox"/>
■	<input type="text" value="T1H"/>	FAM	Green (High)	<input type="checkbox"/>
■	<input type="text" value="T2"/>	HEX	Yellow	<input type="checkbox"/>
■	<input type="text" value="T3"/>	TAMRA	Orange	<input type="checkbox"/>

During plate creation, user can import Reaction mix template along with CXTM, like already described in section “Importing reaction mixes from templates”. To ease identification, they have special **CXTM** icon.

Import reaction mix template ✕

Search by template or reaction mix name 🔍

Sort by: Modification date (desce...

my_RM_with_CXTM

RM_CXTM

rmix-template

RM1

CXTM icon () , informing that reaction mix consists of CXTM, is presented on Reaction mix General View and Detailed List, during assigning Reaction mix to wells, and on well information modal.

After importing, user can review reaction mix and CXTM parameters and edit the Reaction mix name, the Target name, Internal control option, Total volume parameter, or color. In addition, the amplitude multiplexing function can be activated. Depending on modification, the CXTM can be kept or will be detached.

The following edits that do not affect the CXTM can be performed:

- Change reaction mix name
- Change total volume
- Change color
- Change targets names
- Remove some of targets/channels (whole rows using thrash icon), but at least one of channels from prepared CXTM (visible in details windows above) needs to be remained.

When amplitude multiplexing is applied, one part of channel (Low or High) is sufficient.

- Apply Amplitude multiplexing split for any channel(s).

After applying AM split, both parts (High and Low) need to have the same dye, and this dye must be the same as set in CXTM. For example, if CXTM consists channel Green with dye FAM and user decided to apply AM split on channel Green, then Green (Low) and Green (High) parts must have FAM set as a dye to keep that CXTM.

- Enable Internal control option

Edit Reaction Mix

Information (1)

Warning (1)

When selecting Amplitude Multiplexing, please ensure that High-Multiplexing-Reference channel in imaging parameters is enabled.

Reaction mix name * Characters left: 93 Total volume

RM_CXTM 100 µl Change color

Amplitude multiplexing ▲

Select all Green Yellow Orange Red Crimson Far red Green / Yellow

Yellow / Orange Orange / Red Red / Crimson Crimson / Far red

Extm CXTM applied Details ▼

Color	Target Name *	Dye	Channel(s) *	Internal control	
■	T1L	FAM	Green (Low)	<input type="checkbox"/>	
■	T1H	FAM	Green (High)	<input type="checkbox"/>	
■	T2	HEX	Yellow	<input type="checkbox"/>	
■	T3	TAMRA	Orange	<input type="checkbox"/>	
■	T4L	ROX	Red (Low)	<input checked="" type="checkbox"/>	
■	T4H	ROX	Red (High)	<input checked="" type="checkbox"/>	
■	T5	Quasar 680	Crimson	<input type="checkbox"/>	

Changes made in reaction mix that will keep CXTM.

Performing one of the following changes results in the loss of the CXTM:

- Dye change
- Addition of channel that was not included for CXTM creation

The following warning is shown in case of dye change and/or channel addition:

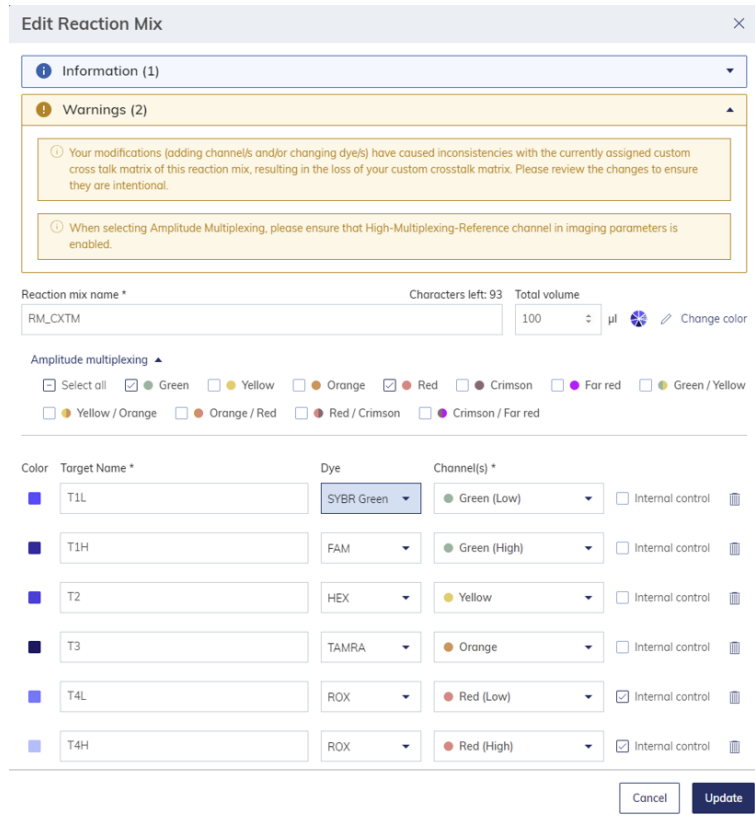

To save the changes, click the **Update** button and **Save**.

For experiments where high multiplexing channel combinations are activated, the user is warned during reaction mix creation that preparation of CXTM is recommended to obtain accurate results.

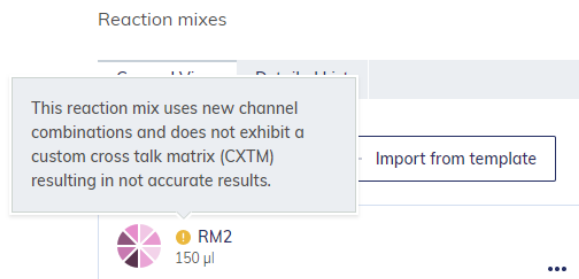

Similar warnings (exclamation mark) are presented on Detailed List.

Reaction mixes

General View Detailed List

New Reaction Mix Import from template

Reaction Mix Name	Total volume	Target Color	Target Name	Dye	Channel	IC
RM2	150 µl		1			-
			2			-
			3			-
			4			-
			5			-
			6			-
			7			-
			8			-

And later on Analysis:

3 Warnings

- The signal for channels Orange, Green / Yellow reached the saturation in wells A7-A8. Try re-imaging the plate with reduced exposure time and gain settings to fix this issue.
- Differences have been detected between imaging parameters set for this plate and imaging parameters used for configuration of CXTM used in Reaction Mix: RMXBB
- Channel cross talk notice**
Reaction mixes "RM2", "RM1" use new channel combinations and do not exhibit a custom cross talk matrix (CXTM). This might result in incorrectly set thresholds which may lead to inaccurate results. Create a custom cross talk matrix according to the user manual or assign an existing reaction mix template which includes a custom cross talk matrix.

List Signalmap Heatmap Histogram 1D Scatterplot 2D Scatterplot Concentration diagram

Add to report Show mean values for replicates Export to CSV...

Sample/NTC/Control	Reaction Mix	Name	Channel	IC	Control	Conc. ^{II} cp/mL	CI (95%)	Valid	Partitions Positive	Negative	Threshold
A1 S01	RM1 Ref channel: HMR-Ref		-	-	-	2453.9	4.0%	4504	2546	1958	36.34
			-	-	-	2453.9	4.0%	4504	2546	1958	37.61
			-	-	-	2440.3	4.0%	4504	2537	1967	36.34
			-	-	-	2453.9	4.0%	4504	2546	1958	42.71
			-	-	-	2446.3	4.0%	4504	2541	1963	45.26
			-	-	-	2455.4	4.0%	4504	2547	1957	39.53
			-	-	-	2444.8	4.0%	4504	2540	1964	71.40
			-	-	-	2444.8	4.0%	4504	2540	1964	70.76

← Back to plate configurator 0 items selected Create report

- Channel cross talk notice (third on warning list above) warns which reaction mixes are missing CXTM. (If no reaction mixes are assigned to plate layout warning is very similar but does not point reaction mixes names.)
- Exclamation mark on List View – similar like on **Reaction mixes** tab.
- Additionally, when Imaging settings (channels, exposure and duration) on Plate are different, than the one used in Reaction Mix imported from template with CXTM, another warning (second on warning list above), listing reaction mixes with that issue, is presented.

7.6.5. Images

1. The Software Suite also enables you to view the images. After a run is completed, user can view the images in the Plate Analysis environment. For more information about how to access the Plate Analysis, see section “Accessing the analysis environment”. To access the images, click **Check source images** icon.
2. To select a channel, click the corresponding button next to the relevant channel. Only channels where imaging took place are available.
3. To zoom in and out, click the image.
4. To download, click the image to open it on a new window. Then, click the  icon located at the top left corner of the image.

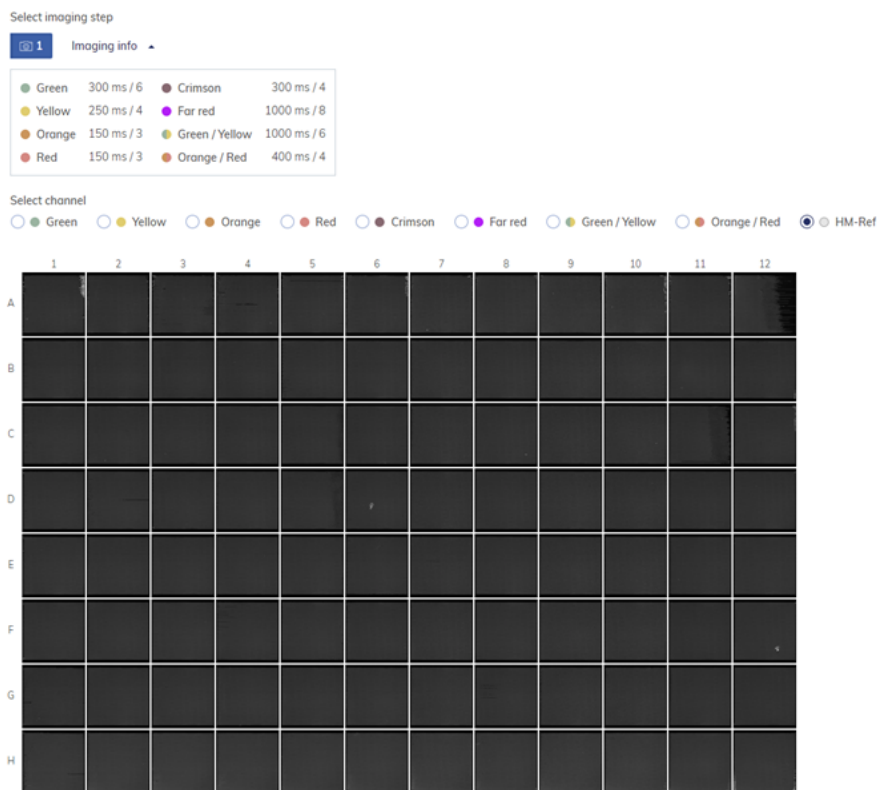



Note: Errors affecting single wells or empty wells are indicated by a  symbol in the affected well. Try reimaging the plate with different exposure and/or gain settings. If the error persists, create a support package and contact QIAGEN Technical Services.

Image quality control

The fluorescence signal in the reference channel is measured to determine the number of valid partitions in a well. Differences in the signal intensities between partitions are normalized, and the fluorescence signals in the target channels are corrected accordingly.

If the fluorescence signal is saturated in too many partitions of a well in a target channel, a warning message will be shown to the customer. Furthermore, saturated signals are marked with  in the Results overview. Saturated signals lower the signal-to-noise ratio and can lead to improper analysis results, for example, the cross talk correction algorithm might be affected. The recommendation is to re-image the plate with 30% less exposure time in the respective channel.

Note: The optimal RFU range of your positives is between 80 and 120 to avoid saturation and proper functioning of image analysis algorithms. Use exposure time changes (linear dependency) to optimize your RFU level. For RFU values below 60, it is recommended to increase the exposure time of the corresponding channel/s, and for RFU values below 150, it is recommended to decrease the exposure time of corresponding channel/s.



In case more than one imaging step has been done, the imaging step where the saturation occurred is marked in yellow and the warning message is shown when moving the mouse over the **camera** icon.



7.6.6. Invalidation of images

In rare cases, the image quality can be too low and the image cannot be used for further analysis. A message is shown to the customer that some wells have been invalidated. Those wells are grayed out in the plate layout and cannot be used for the result analysis.

Note: This message also appears if not all wells were used in the run. For that situation, ignore the message.

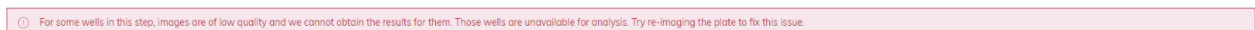

In case more than one imaging step has been done, the imaging step where the low signal quality occurred is marked in red and the message is shown when moving the mouse over the **camera** icon.

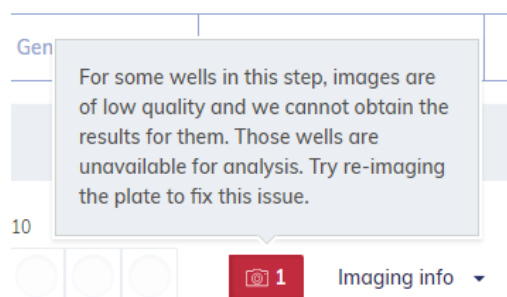

Reasons for the invalidation of an image are:

1. Too less fluorescence signal, for example, when the Nanoplate was re-imaged after a long storage period (see "Operating Plates" for information about the storage of plates).
2. Vibration during the imaging process can lead to blurry images. If the image of the reference channel is affected, the number of valid partitions cannot be determined and the whole well is invalidated for analysis. If a target channel is affected, only the image of the respective channel is invalidated for analysis.
3. Incomplete filling of a well can lead to too less valid partitions in the reference channel needed for analysis. In this case, the whole well is invalidated.

7.6.7. Image corrective measures

To ensure proper analysis based on valid partitions, artifacts that could influence the result analysis are removed from the images. The corrections are done automatically by the QIAcuity Software Suite and do not require any user action. The partitions that are affected by artifacts are blacked out and are invalidated for further analysis. Artifacts can be:

1. Dust and other particles
2. Low amplification areas
3. Areas of bad filling

7.6.8. Dust and other particles

Dust and other particles like hairs or strands are detected by the QIAcuity Software Suite and are removed from the images. This figure shows an example of a well before and after dust/other particles correction.

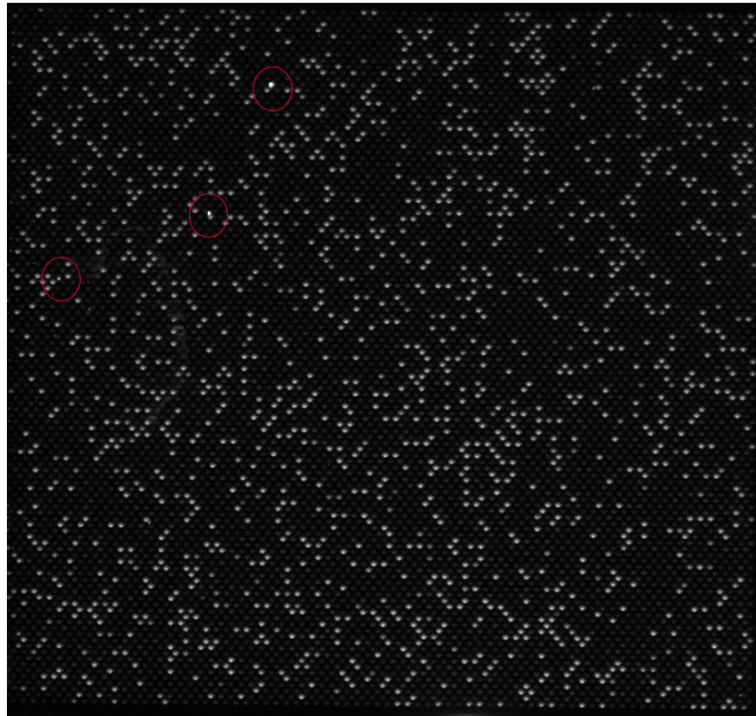

Raw image of a well showing dust particles (marked with red circles).

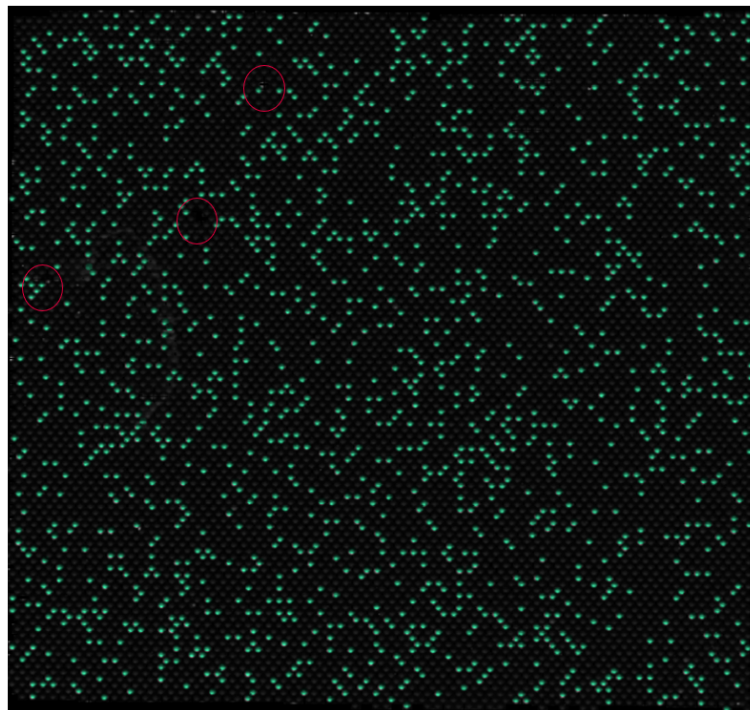

Signal map of the dust-corrected image.

In case the images still show dust particles or other particles after the correction, the recommendation is to unload the plate, wipe the plate with a lint-free tissue and to re-image the plate.

Note: For QIAcuity Software Suite version 2.0 or higher, dust detected in one channel is used for finding dust in other channels as well. If required, to improve dust detection, always image all channels even not used by assay(s).

The QIAcuity Software Suite version 2.1 exhibits an improvement for dust detection for dust causing light infections of neighbor partitions. This figure shows an example of a well before and after smear dust correction.

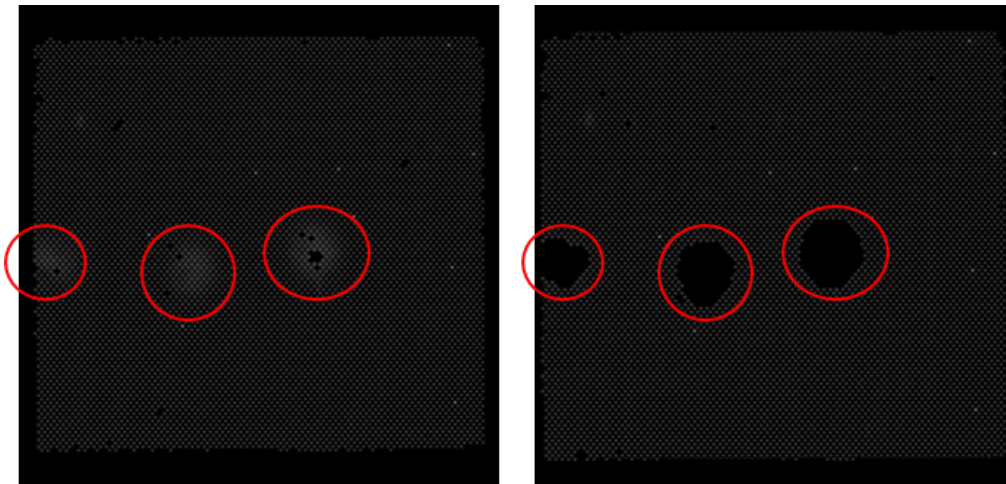

Improved dust detection for dust causing light infections of neighbor partitions: left, not sufficient dust removal; right, sufficient dust removal with QIAcuity Software Suite version 2.1. Affected area is removed from analysis and therefore partitions are invalidated.

7.6.9. Low amplification areas

In case of low amplification areas, the fluorescence signal in the target channels is less pronounced or not detectable in certain areas of the well. The signal in the reference channel is not affected. If an equal amplification did not take place in the well, the area of low amplification does not meet the requirements for Poisson distribution. Therefore, the partitions in those areas are blacked out in the image and are not included in the analysis.

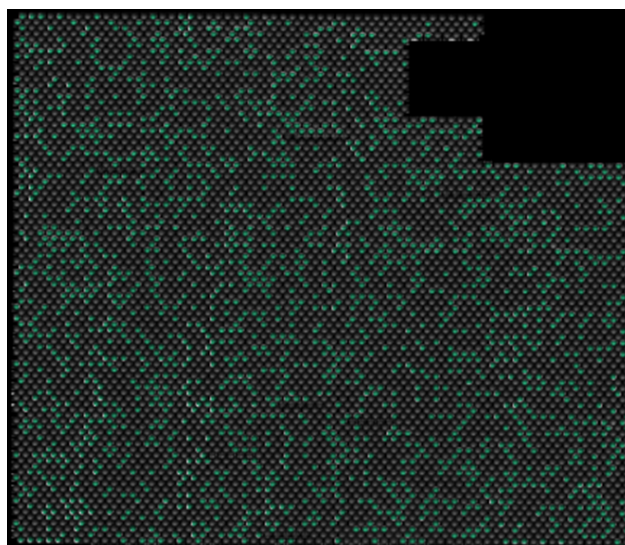

Signal map of an image with blacked-out low amplification areas.

7.6.10. Areas of bad filling

Incorrect pipetting or sealing can lead to areas of the well which are not filled with reaction mix. Those areas affect the reference channel as well as the target channels and reduce the number of valid partitions. See “Operating Plates” for instructions on how to pipet and seal the Nanoplates properly.

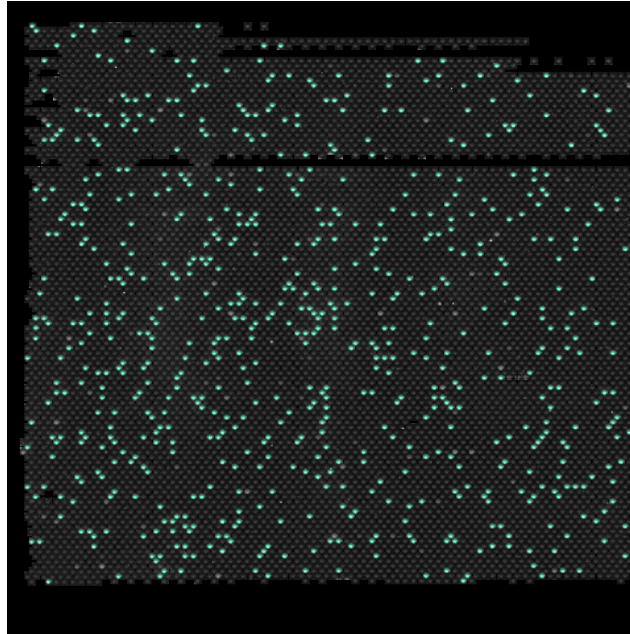

Signal map of an image showing areas of bad filling.

7.6.11. Amplitude multiplexing

Starting with QIAcuity Software version 3.1, the amplitude multiplexing option is available next to the optical channel multiplexing. Amplitude multiplexing utilizes the differences of amplitude in fluorescence intensity of partitions. By setting the appropriate three thresholds, four bands of partitions can be clustered: double positives, high target positives, low target positives, and low target negatives.

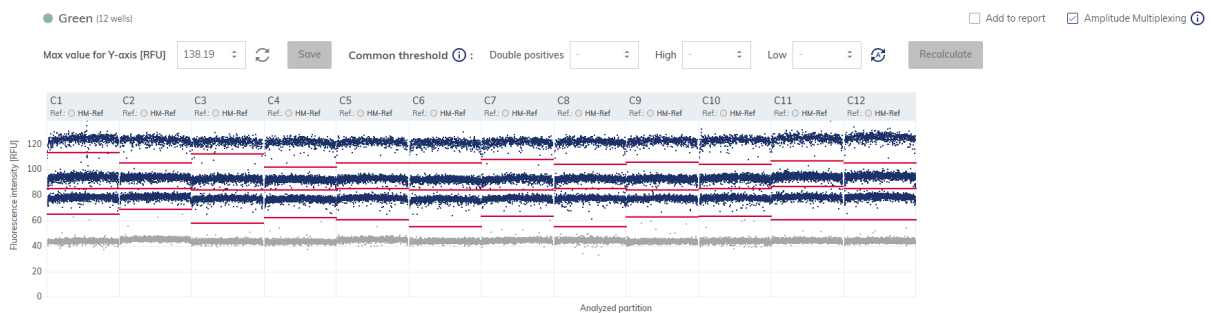

For amplitude multiplexing usage, each channel is divided into a High and a Low part. Up to 16 channels (including High and Low) can be defined in total. Refer to the “Reaction mixes tab” section for more details on how to prepare reaction mix with amplitude multiplexing usage. Refer to the “Absolute quantification” section for more details about how to enable and use amplitude multiplexing during analysis.

7.6.12. Cross talk correction

Depending on the optical configuration of the QIAcuity instrument, user can detect up to two or eight fluorescent channels. To compensate the spectral overlap between the fluorescent dyes, a cross talk correction algorithm is implemented in the QIAcuity Software Suite.

When up to six standard channels are used in experiment, the correction is done automatically by the software by a default cross talk matrix and does not require any user action. The bleed-through signals are removed from the images and are not taken into account in the result analysis. The cross talk correction is correcting an absolute value based on the RFU level of the neighbor channel.

For multiplex channel combination usage, a dedicated custom cross talk matrix needs to be prepared upfront and the reaction mix template should be applied in the experiment.

Refer to the “Custom cross talk matrix” section for more details on how to prepare custom cross talk matrix to apply above correction.

The bleed-through signals are removed from the images and are not taken into account in the result analysis. The cross talk correction is correcting an absolute value based on the RFU level of the neighbor channel.

Note: In case insufficient compensation or overcompensation is seen (e.g., as double negative bands), check the RFU level of positive signals of neighbor channels if saturated or very bright. By lowering the RFU level of positive signals, the insufficient compensation or overcompensation might be reduced.

7.6.13. Reference channel discrepancies

When different reference channels have been assigned to wells with the same reaction mix (reference channel discrepancies), it can lead to the situation that customer will obtain inaccurate results. Such situation may happen in case of human error, for example, during pipetting reaction mix to well or reference channel has been wrongly recognized (e.g., due to image quality).

Important: In case of reference channel discrepancy, well cannot be grouped into hyperwells.

Software version 3.0 informs the user about reference channel discrepancies.

In the following example, despite the same reaction mix has been assigned to wells A1 and B1, different reference channel has been detected: Std-Ref in well A1 and HM-REF in well B1.

Well Information (A1) ✕

Reaction mix name: RM
 Total volume per well: -
 Ref. channel: @ 1: Std-Ref
 @ 2: -

	Target	IC	Dye	Channel
1	■ green	-	FAM	● Green

Close

Well Information (B1) ✕

Reaction mix name: RM
 Total volume per well: -
 Ref. channel: @ 1: HM-Ref
 @ 2: -

	Target	IC	Dye	Channel
1	■ green	-	FAM	● Green

Close

In such case, user is warned about discrepancy in:

- **Plate layout** – Indicator is presented if discrepancy exists on any of Imaging step.

Different reference dyes were detected for the following wells, which do not match the pre-settings of the reaction mix. Please check whether the reaction mix assignment was carried out correctly and adjust the plate layout if necessary.

	1	2	3	4	5	6	7	8	9	10	11	12
A	●	●	●	● 01	●	● 02	●	●	●	● 02		
B				● 01	●	●	●	●	●	●		
C												
D												
E												
F												
G												
H												

- **Analysis**

- **Warning** – User can go back to plate configurator and do needed adjustments.



- **Exclamation mark** on List view next to wells with reference discrepancies.

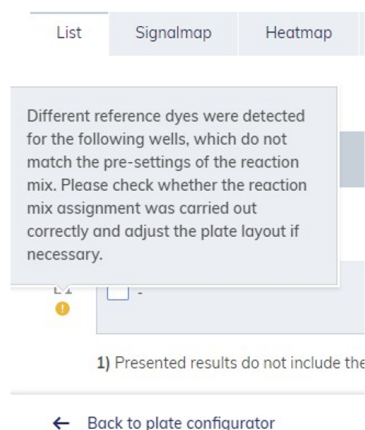

- **CSV export – Current results** – “REF” if particular wells have different reference channel assigned.

- **Reports**

- Section “Warnings” presents Reaction mix, Imaging step, and Wells with reference channel discrepancy issue.
- List View – when added contains exclamation marks next to wells informing which wells have issue.

7.6.14. General analysis options

Selecting wells for analysis

1. To select multiple wells at the same time, click the individual wells or click one well then drag your mouse until all wells are selected.
2. To select all wells, click **Select all**.
3. To remove a selected well, click the well.
4. To remove all selected wells, click **Unselect all**.

Select source of analysis (9 wells)

	1	2	3	4	5	6	7	8	9	10	11	12
A		01	01	01	01	01	01	01	01	01		
B		02	02	02	02	02	02	02	02	02		
C		03	03	03	03	03	03	03	03	03		
D		04	04	04	04	04	04	04	04	04		
E		05	05	05	05	05	05	05	05	05		
F		06	06	06	06	06	06	06	06	06		
G		07	07	07	07	07	07	07	07	07		
H		NTC	NTC	NTC	NTC	NTC	NTC	NTC	NTC	NTC		

Select all Unselect all Group as hyperwells Ungroup hyperwells

To view more information about an individual well, double-click the well in the plate layout. The Well Information dialog box appears. Click **OK** to close the dialog box.

Well Information (A2) ✕

Reaction mix name: DPH218 ERBB2 + DPH186 TERT Concentration factor: -

Total volume per well: - Template volume per well: -

Sample ID: 01 Conversion factor: -

Sample name: 1ng gDNA Conversion unit: -

Ref. channel: @ 1: Std-Ref

Target	IC	Dye	Channel
1 <input type="checkbox"/> DPH218 ERBB2	-	FAM	<input type="checkbox"/> Green
2 <input type="checkbox"/> DPH186 TERT	-	HEX	<input type="checkbox"/> Yellow

Close

Hyperwells

To achieve higher accuracy, multiple wells can be grouped together and analyzed as a single well. To define a hyperwell, select multiple wells with the same reaction mix and same sample name.

	1	2	3	4	5	6	7	8	9	10	11	12
A		01	01	01	01	01	01	01	01	01		
B		02	02	02	02	02	02	02	02	02		
C		03	03	03	03	03	03	03	03	03		
D		04	04	04	04	04	04	04	04	04		
E		05	05	05	05	05	05	05	05	05		
F		06	06	06	06	06	06	06	06	06		
G		07	07	07	07	07	07	07	07	07		
H		NTC	NTC	NTC	NTC	NTC	NTC	NTC	NTC	NTC		

Select all Unselect all Group as hyperwells Ungroup hyperwells

By clicking **Group as hyperwells**, the software automatically groups all selected samples exhibiting the identical reaction mix and sample to hyperwells. User can get the same result by right-clicking and selecting **Group as hyperwell** from the context menu for previous selected wells.



To ungroup the hyperwell, select the hyperwell and click **Ungroup hyperwell** from the menu below or from the context menu.

For the analysis, hyperwells are treated as a single well but with a larger number of partitions. This may be helpful for rare event detection if the sample volume to be analyzed exceeds the volume that can be loaded into a single well. Results from all wells coupled into a hyperwell will be aggregated and presented as a result from a single well.

Details about CI calculation and concentration determination in hyperwells are described in the *QIAcuity User Manual Extension: QIAcuity Application Guide* available at www.qiagen.com.

Hyperwells can be selected for Absolute Quantification, Mutation Detection, and Genome Editing, Copy Number Variation, and Gene Expression analysis.

Using hyperwells in copy number variation and gene expression analysis

1. Select reference sample from the drop-down list.

Reference sample *

Select sample from the list

Reference sample * Copies/genome *

01 sample_0101

Target of interest *

Select target from the list

Reference selection *

Select target of interest first

Reference target(s) *

Select at least one target from the list

2. Then, enter the number of copies/genome. You can choose the value between 1 and 99.

Select imaging step

1 2

Reference sample * Copies/genome *

01 sample_0101 2

Target of interest *

mutant_A (Yellow)

Reference selection *

Select reference

Reference target(s) *

wildtype_1 (Green)

Show results

Reference selection defines wells, hyperwells that have the same sample ID for the selected reference sample. Select one that you would like to analyze.

3. Select target of interest from the drop-down list.

Reference sample * Copies/genome *

01 sample_0101 2

Target of interest *

mutant_A (Yellow)

Reference selection *

Select reference

Reference target(s) *

wildtype_1 (Green)

4. Reference selection is now unavailable because the wells/hyperwells have not been detected with the same sample ID for the chosen reference sample.

- Click the reference target drop-down list, and select one or more targets.
- Click the **Show results** button to get results.

Below user can find the example when the reference selection is available. In this case, well A2 and hyperwell (A3, B3) have the same sample ID for the selected reference sample.

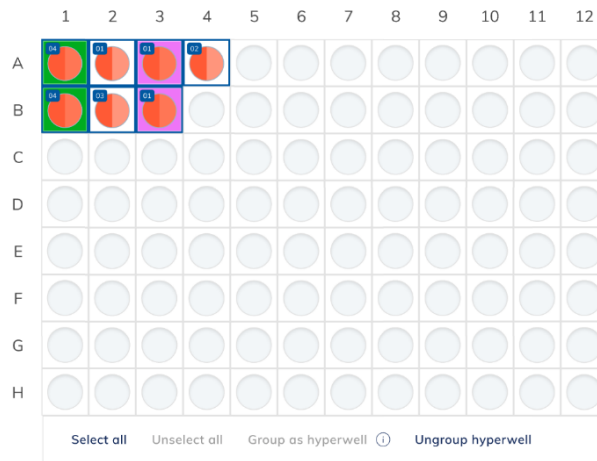

- First select reference sample. In this case, the user has selected sample ID "01 patient 01".

Reference sample*

01 patient 01

- Enter the copies/genome. You can choose the value between 1 and 99. In this case, the user enters "10".

Reference sample* Copies / genome*

01 patient 01 10

- Then, select the target of interest. In the example below, the user has chosen SARS-COV-2 with channel Green.

Target of interest*

01 SARS-COV-2 Green

- The reference selection is available. From the drop-down list are two options: "01 HW2" (hyperwell with selected wells: A3, B3) or "non-hyperwell, all replicates".

In this case, the user has selected "01 HW2".

Reference selection*

01 HW2

5. Next, select reference target(s).

Here, the user has chosen ERBB2 with channel Yellow.

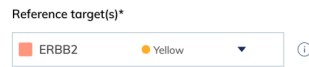

6. If all fields have been selected, you can click the **Show results** button.

Multiple imaging steps

If the plate was configured with multiple imaging steps, user can select the one used for analysis. To select the imaging step, click one of the available boxes indicated by the **camera** icon.

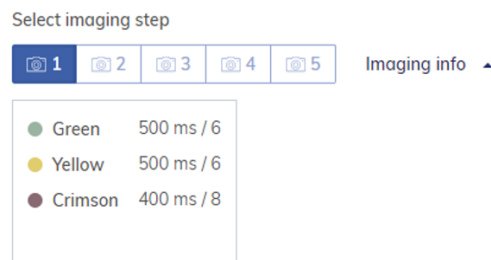

The channels along with the duration and gain settings that were activated in the selected imaging step are shown after expanding **Imaging info** section.

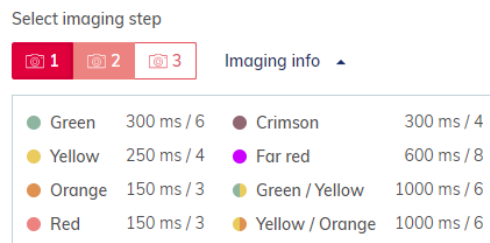

Important: When switching imaging steps, the application will ask to ungroup existing hyperwells. All wells linked as hyperwells will be ungrouped as individual wells.

Note: If an imaging step failed during the run or images are of low quality, a message is shown by moving the mouse over the camera icon to indicate that the results might be incorrect. Furthermore, error messages are indicated with a red box around the image step icon, warnings with a yellow box.

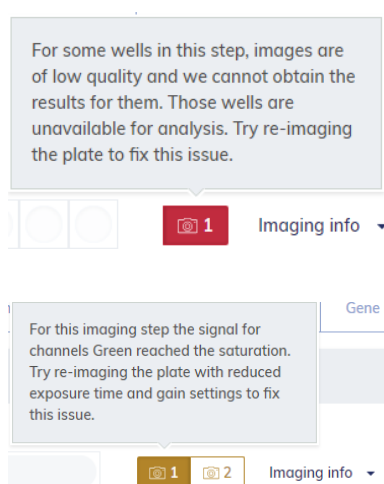

Diagram options

There are several tools related to the diagrams and charts that enable user to adjust the view and download the chart you want to view. To access the tools, point to a diagram. Table 14 shows the toolbar buttons and their corresponding functions.

Table 14. Diagram toolbar buttons

Toolbar buttons	Icons	Functions
Download plot		Downloads the plot as an SVG or PNG file
Pan		Changes the perspective of the graph Moves along the x axis, y axis, or both
Zoom		Enables you to select a part of the diagram to zoom into To reset the zoom, double-click the diagram.
Zoom in		Zooms in the diagram To reset the zoom, double-click the diagram.
Zoom out		Zooms out the diagram To reset the zoom, double-click the diagram.
Reset axes		Resets the axes after the view is panned
Box select		Enables you to select a part of the diagram
Polygon partitions assignments		Available only on 2D Scatterplot: Enables you to select a freehand part of diagram

Note: Each diagram type contains a different set of toolbar buttons.

Horizontal and vertical wells results presentation

From Software Suite version 2.5 onwards for Absolute Quantification, before clicking **Show results**, user can select between Horizontal and Vertical wells results presentation:

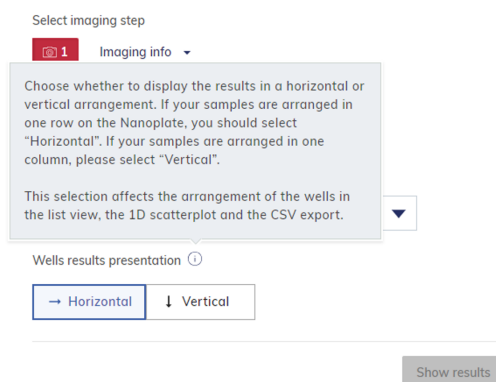

Option Horizontal orders wells results row by row: A_1, A_2 to A_i , then B_1, B_2 to B_i , and so on. Option Vertical orders wells column by column: A_1, B_1 to H_1 , then A_i, B_i to H_i , and so on, where "i" in both cases is the number of column.

Selected wells results presentation (Horizontal or Vertical) affects List View, 1D Scatterplot, and Concentration diagram. It is also reflected in CSV exports (Current results, Multiple Occupancy, and RFU export) and reports.

Dilution calculation option

From QIAcuity Software Suite version 2.5 onwards, there is the possibility to calculate the concentration of the undiluted sample. Dilution calculations can be used in all type of analysis: Absolute quantification as well as in all second-level analysis (Mutation detection, Genome editing, Copy number variation, and Gene expression).

To calculate concentration in undiluted sample ($C_{undiluted}$) following information are required:

1. Total volume value (V_{rm}) of reaction mix per well: Allowed values are in range 1 to 1000 μL .
2. Corresponding sample template volume (V_t) defines the volume of template used during PCR reaction. Allowed values are in range 0.1 to 1000 μL .

Optionally, for sample pre-dilutions: Concentration factor (C_f) of sample refers to the ratio of how sample was pre-diluted. The concentration factor is a multiplier. Allowed values are in range 1 to 1×10^{12} . If a sample was for example pre-diluted with a ratio of 1:100, a concentration factor of 100 needs to be defined.

The following formula is applied to reaction mix dilution (without sample pre-dilution and corresponding concentration factor):

$$C_{undiluted} = \frac{c}{\frac{V_t}{V_{rm}}}$$

Concentration in undiluted sample ($C_{undiluted}$) including sample pre-dilution (concentration factor) is calculated using formula:

$$C_{undiluted} = \frac{c}{\frac{V_t}{V_{rm}}} \times C_f$$

$$C_{undiluted} = \frac{c}{\frac{V_t}{V_{rm}}}$$

Note: The results for undiluted sample concentration is presented per default as cp/ μ L.

Example:

$$C = 120 \frac{cp}{\mu L}$$

$$V_t = 10 \mu L$$

$$V_{rm} = 100 \mu L$$

$$C_f = 1000$$

$$C_{undiluted} = \frac{120}{\frac{10}{1000}} = 1,200,000 \frac{cp}{\mu L}$$

Usage of dilution calculation feature in analysis

Before using dilution calculation for data analysis, make sure all needed samples have dilution factor parameters filled accordingly (described in sections "Defining samples, controls, and non-template controls" and "Reaction mixes tab"). User can use drop icons on plate layout for it.

Example:

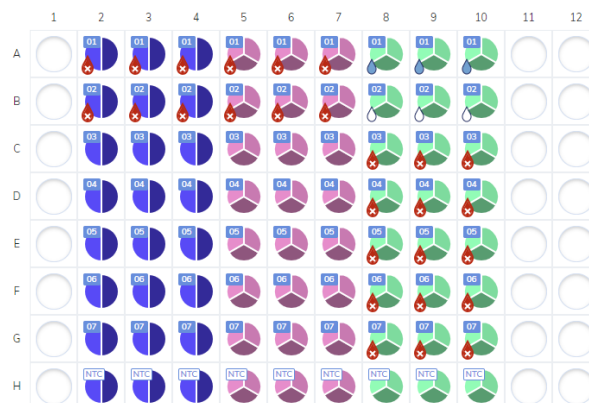

In the aforementioned example, the calculation of undiluted sample concentration will be possible for Sample 01 and 02, but not possible for Sample 03:

1. Sample 01 has total volume, template volume, and concentration factor filled, which is indicated with blue drop icon.

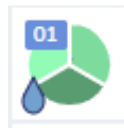

2. Sample 02 has total volume, template volume filled, but concentration factor is empty, which is indicated with empty drop icon.

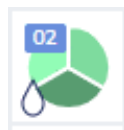

3. Sample 03 has total volume filled but template volume and concentration factor are empty, which is indicated with red drop icon.

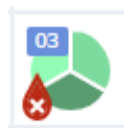

Results visualization

1. List View

The list view column with results of concentration is divided into two sub-columns: dPCR reaction and undiluted sample (based on provided dilution information). When user enables the option to show the mean values for replicates, columns mean concentration and standard deviation (SD) are additionally presented and divided in similar manner.

Sample/NTC/Control	Reaction Mix	Channel		Conc. [cp/mL] ²		CI (95%)		Partitions			Threshold	
		Name	IC	Control	dPCR reaction	Undiluted sample	dPCR reaction	Valid	Positive	Negative		
A2	1x 1ng gDNA Conc. factor: 5 Template volume: 50 µL DPH218 ERBB2 + DPH186 TERT Ref. channel: ① 968-Ref	Green	-	-	26.51	-	23.4%	8240	70	8170	8240	63.11
		Yellow	-	-	23.09	-	25.1%	8240	61	8179	8240	78.41
		Red	-	-	0.000	-	-	8240	0	8240	8240	14.28
A3	1x 1ng gDNA Conc. factor: 5 Template volume: 50 µL DPH218 ERBB2 + DPH186 TERT Ref. channel: ① 968-Ref	Green	-	-	28.82	-	22.5%	8255	76	8179	8255	61.20
		Yellow	-	-	23.48	-	24.9%	8255	62	8193	8255	91.16
		Red	-	-	0.000	-	-	8255	0	8255	8255	15.56
A4	1x 1ng gDNA Conc. factor: 5 Template volume: 50 µL DPH218 ERBB2 + DPH186 TERT Ref. channel: ① 968-Ref	Green	-	-	24.44	-	24.5%	8210	64	8146	8210	73.95
		Yellow	-	-	27.51	-	23.1%	8210	72	8138	8210	89.89
		Red	-	-	0.000	-	-	8210	0	8210	8210	13.01
A5	1x 1ng gDNA Conc. factor: 5 Template volume: 50 µL DPH218 ERBB2 + DPH186 TERT + DPH464 SPIN4 Ref. channel: ① 968-Ref	Green	-	-	32.24	-	21.3%	8269	85	8184	8269	80.33
		Yellow	-	-	25.77	-	23.8%	8269	68	8201	8269	92.44
		Red	-	-	14.75	-	31.4%	8269	39	8230	8269	74.59
A6	1x 1ng gDNA Conc. factor: 5 Template volume: 50 µL DPH218 ERBB2 + DPH186 TERT + DPH464 SPIN4 Ref. channel: ① 968-Ref	Green	-	-	38.16	-	19.5%	8260	101	8159	8260	77.78
		Yellow	-	-	30.56	-	21.8%	8260	81	8179	8260	88.61
		Red	-	-	18.45	-	28.0%	8260	49	8211	8260	80.33

Note: Similar column division is also used in CSV export: Current results and in report.

2. Heatmap

To display concentration for undiluted sample on Heatmap user needs to check the checkbox “Use sample dilution”:

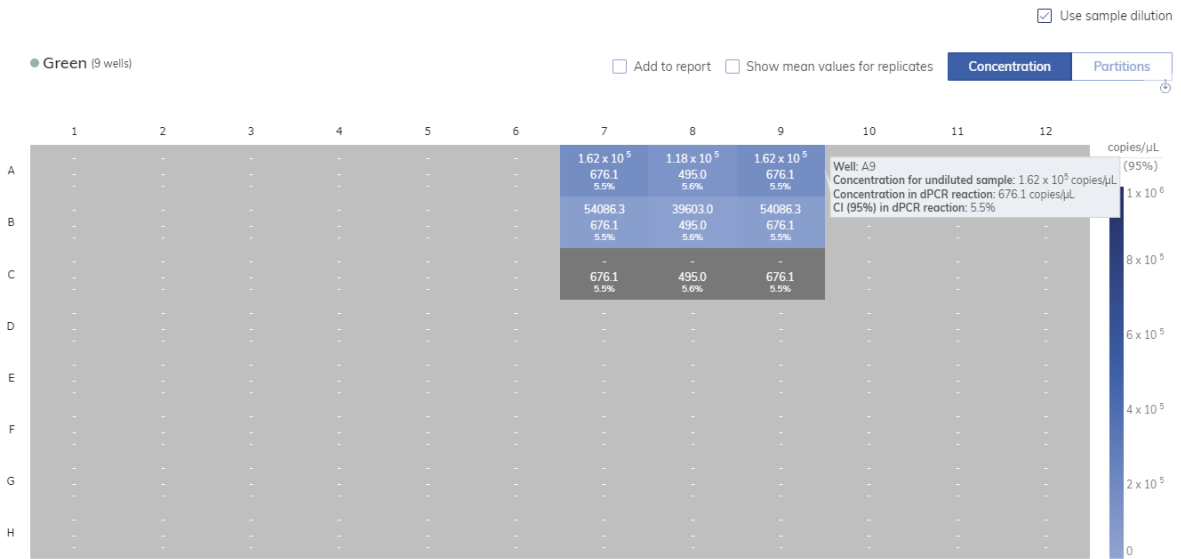

3. Concentration diagram

On the concentration diagram, user needs to check the checkbox to display concentration for undiluted sample:

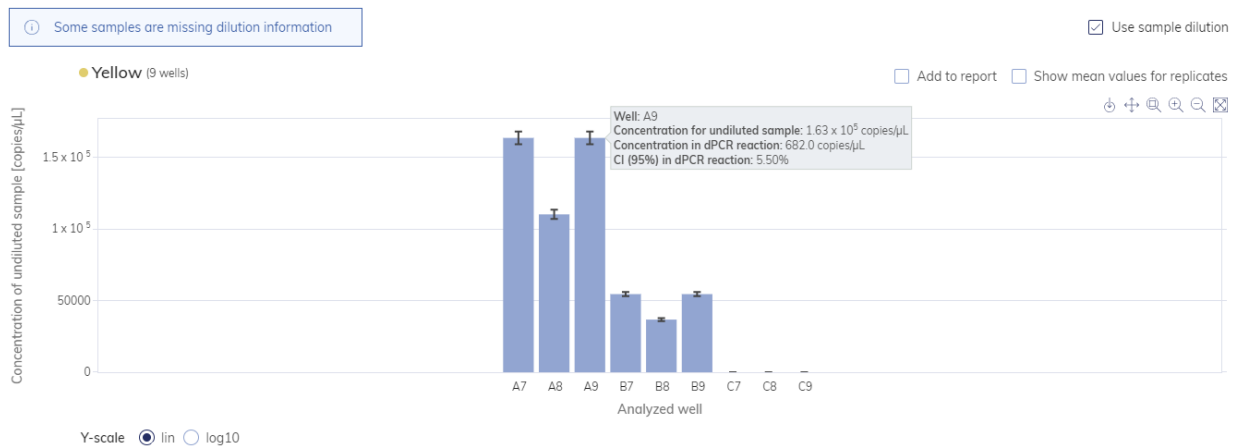

Note: Results visualization works the same on for absolute quantification and all second-level analysis (Mutation Detection, Genome Expression, Copy Number Variation, and Gene Expression).

Conversion factor

From QIAcuity Software Suite version 2.5 onwards, there is possibility to convert concentration result by default given in copies per microliter, into another unit defined by the user. Conversion factor can be used in absolute quantification as well as in second-level analysis (Mutation detection, Genome editing, Copy number variation, and Gene expression). Result can be also combined with dilution factor so it allows user to obtain results of undiluted concentration in any custom unit.

Software provides following default units:

cp/mL, ng/μL, pg/μL, vg/mL, vg/μL.

On top of that, user can introduce custom units to the system.

To convert the unit, user needs to input two additional parameters during sample definition: conversion factor and unit. Concentration result is just multiplied by conversion factor and expressed in given unit.

Examples:

1. The single copy gene CDKN2A has been detected in genomic DNA isolated from human leukocytes. Knowing that the weight of the haploid human genome is approximately 3.3 pg per cell, 100 copies/ μL of the target corresponds to **(a)** 330 pg of DNA/ μL and **(b)** to 50 cell equivalents (with diploid genome)/ μL .

Conversion from copies/ μL into pg/ μL :

$$C_{\text{undiluted}} = 100 \frac{\text{cp}}{\mu\text{L}}$$

$$\text{conversion factor} = 3.3$$

$$\text{unit} = \frac{\text{pg}}{\mu\text{L}}$$

$$C_{\text{undiluted converted}} = 330 \frac{\text{pg}}{\mu\text{L}}$$

Conversion from copies/ μL into cell equivalents:

$$\text{conversion factor} = \frac{1}{2} = 0.5$$

$$\text{unit} = \frac{\text{cells}}{\mu\text{L}}$$

$$C_{\text{undiluted converted}} = 50 \text{ cells}/\mu\text{L}$$

2. The 16S rRNA gene has been detected in genomic DNA isolated from *E. coli* cells. The copy number of the 16S rRNA gene is 7 per one *E. coli* cell. The weight of one *E. coli* genome is approximately 5.1 fg. A total of 1000 copies of the target corresponds to **(a)** 729 fg of DNA and **(b)** to approximately 1423 cell equivalents.

Conversion from copies/ μL into fg/ μL :

$$C_{\text{undiluted}} = 1000 \frac{\text{cp}}{\mu\text{L}}$$

$$\text{conversion factor} = \frac{5.1}{7} = 0.729$$

$$\text{unit} = \frac{\text{fg}}{\mu\text{L}}$$

$$C_{\text{undiluted converted}} = 729 \text{ fg}/\mu\text{L}$$

Conversion from copies/ μL into *E. coli* equivalents:

$$C_{\text{undiluted}} = 1000 \frac{\text{cp}}{\mu\text{L}}$$

$$\text{conversion factor} = \frac{1}{7} = 0.143$$

$$\text{unit} = \frac{E. coli}{\mu\text{L}}$$

$$C_{\text{undiluted converted}} = 142.8 E. coli/\mu\text{L}$$

Usage of conversion factor in analysis

To use conversion factor in analysis, make sure all needed samples have conversion factor and unit filled accordingly (described in section “Defining samples, controls, and non-template controls”).

Note: If the selected wells for analysis exhibit different defined conversion units, or a mixture of converted and non-converted wells is present, no converted data will be analyzed and displayed by the software.

Note: The conversion function is only available for samples, not for controls nor non template controls.

Results visualization

1. List View

To display converted results on list view user needs to select wells for analysis exhibiting an identical conversion factor unit and enable checkbox “Use conversion factor”. Otherwise, checkbox is disabled and following information is presented on tooltip:

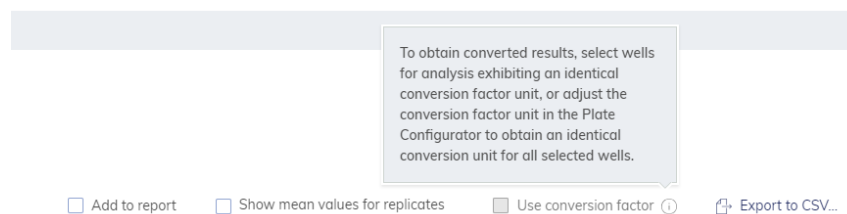

When all selected wells for analysis exhibit identical conversion unit, the converted result concentration is displayed in addition the default sample result concentration (copies/ μ L)

When all parameters were filled correctly, Concentration column is divided in following way:

- a. dPCR reaction has three sub-columns:
 - dPCR reaction concentration (cp/ μ L)
 - Converted dPCR concentration (custom unit)
 - CI (95%)
- b. If dilution factor was applied, then Undiluted sample is additionally presented with following columns:
 - Undiluted concentration (cp/ μ L)
 - Converted undiluted concentration (custom unit)

When user enables the option to show mean values for replicates, columns: mean concentration and standard deviation (SD) are additionally presented.

Note: Sample name and assigned reaction mix must be identical to enable the **replication calculation** option.

Well	Sample/NTC/Control	Reaction Mix	Channel			Concentration				Partitions			Threshold	
			Name	IC	Control	dPCR Reaction			Undiluted sample		Valid	Positive	Negative	
						cp/μL	cp/mL	CI (95%)	cp/μL	cp/mL				
A2	1 ng gDNA Conc. factor: 5 Template volume: 10.0 μL Clono factor: 2 Conc. unit: cp/mL	DPH219 ERBB2 + DPH186 TE RT Total volume: 100.0 μL Ref. channel: 968-Ref	Green	-	-	26.51	53.01	23.4%	1325.3	2650.7	8240	70	8170	63.11
			Yellow	-	-	23.09	46.17	25.1%	1154.3	2308.6	8240	61	8179	78.41
A3	1 ng gDNA Conc. factor: 5 Template volume: 10.0 μL Clono factor: 2 Conc. unit: cp/mL	DPH219 ERBB2 + DPH186 TE RT Total volume: 100.0 μL Ref. channel: 968-Ref	Green	-	-	28.83	57.66	22.5%	1441.4	2882.8	8253	76	8177	61.20
			Yellow	-	-	23.50	47.00	24.9%	1174.9	2349.8	8253	62	8191	91.16
A4	1 ng gDNA Conc. factor: 5 Template volume: 10.0 μL Clono factor: 2 Conc. unit: cp/mL	DPH219 ERBB2 + DPH186 TE RT Total volume: 100.0 μL Ref. channel: 968-Ref	Green	-	-	24.44	48.88	24.5%	1222.0	2444.0	8210	64	8146	73.95
			Yellow	-	-	27.51	55.02	23.1%	1375.4	2750.8	8210	72	8138	89.89

2. Heatmap

To display converted result concentration, user needs to enable checkbox "Use conversion factor". Results are displayed in custom unit. In addition, the result presentation of both diluted and converted concentration results can be selected by use of "Use sample dilution" and "Use conversion factor".

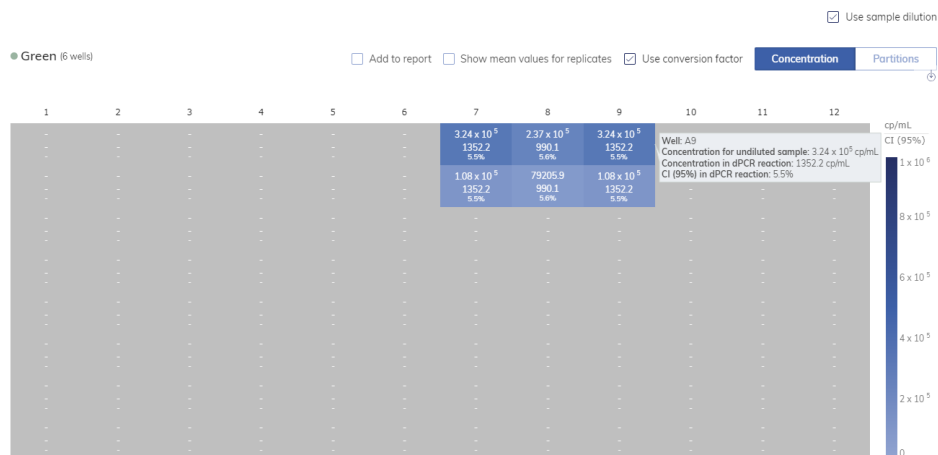

3. Concentration diagram

On the concentration diagram, user needs to check the same checkbox to display converted concentration that also can be combined with dilution factor.

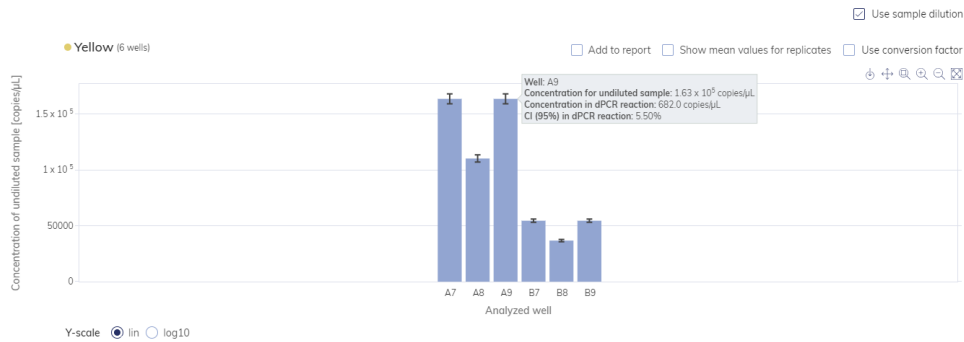

Note: Results visualization for all second-level analysis (Mutation Detection, Genome Editing, Copy Number Variation, and Gene Expression) works the same as for the Absolute Quantification.

Range sliders

If more wells are selected for the analysis than fit on a chart, some charts such as concentration diagrams or point diagrams offer the additional option of a range slider. This tool lets user view the data that do not fit on the diagram. User can also adjust the range of data that is shown to see more information at the same time.

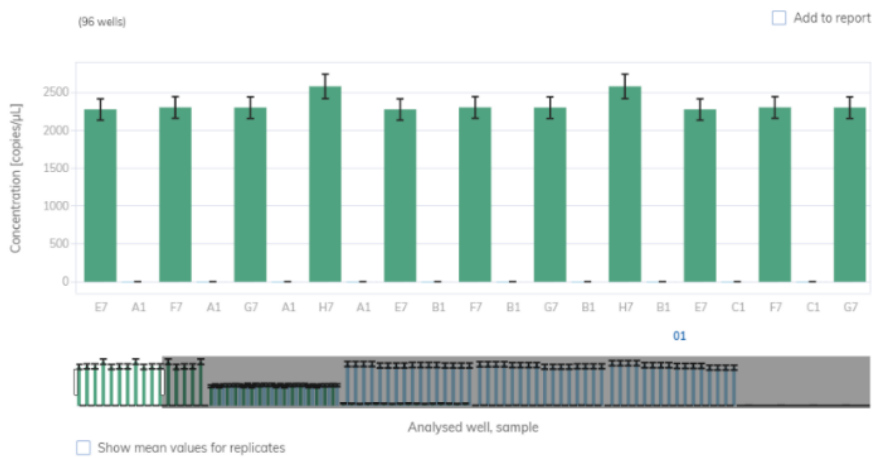

Example of a range slider below a chart.

The highlighted area of the slider shows the portion of the chart that is currently displayed. The gray part of the slider is a preview of the rest of the chart.

To view another part of a diagram, click the highlighted area of the slider and drag to the part that user wants to view.

To adjust the range of the displayed data, click one of the handlebars on the left or right side of the highlighted area and drag until the preferred range is reached.

7.6.15. Absolute quantification

The **Absolute Quantification** tab is the first tab in the Analysis environment. After selecting the wells to be analyzed, user can view lists, signal maps, heatmaps, histograms, 1D scatterplots, 2D scatterplots, and concentration diagrams in this tab.

The total number of copies of the target molecule in all valid partitions of a well is calculated by multiplying the copies of the target molecule per partition with the number of valid partitions. We use an intermediary quantity, λ , interpreted as average number of target molecules in a single partition.

The estimation of λ is probabilistic in its nature, and the uncertainty of λ is described by the normal distribution centered around the following mean $\hat{\lambda}$:

$$\lambda = -\ln\left(\frac{\text{Number of valid partitions} - \text{Number of positive partitions}}{\text{Number of valid partitions}}\right)$$

The 95% confidence interval of this distribution is a range given by

$$CI_{\text{low}} = \lambda_{\text{low}} = -\ln\left(1 - p + 1.96\sqrt{\frac{p(1-p)}{\text{Number of partitions}}}\right)$$

$$CI_{\text{high}} = \lambda_{\text{high}} = -\ln\left(1 - p - 1.96\sqrt{\frac{p(1-p)}{\text{Number of partitions}}}\right)$$

Where

$$p = \frac{\text{Number of positive partitions}}{\text{Number of valid partitions}}$$

Example:

For simplicity, the assumption is that we have 8500 total partitions with 8000 partitions that are valid and from those 4000 partitions are positive. The estimated number of copies of the target molecule in a partition is

$$\lambda = -\ln\left(\frac{8000-4000}{8000}\right) = 0.6931471805599450\dots$$

By using the formula for the standard error of the uncertainty, this can be estimated:

$$CI_{\text{low}} = \lambda_{\text{low}} = -\ln\left(0.5 + 1.96\sqrt{\frac{0.5 \times 0.5}{8000}}\right) = 0.67147036342047\dots$$

$$CI_{\text{high}} = \lambda_{\text{high}} = -\ln\left(0.5 - 1.96\sqrt{\frac{0.5 \times 0.5}{8000}}\right) = 0.71530431303236\dots$$

The CI range is equal to $CI_{high} - CI_{low} = 0.04383...$. This range is used to determine how many digits of the result are significant.

The result is based on detecting 4000 positive partitions out of 8000 total valid, the λ parameter is distributed with around a value $\lambda = 0.693$ and there is 95% certainty that the true value lays between $\lambda \in 0.671...0.715$. This equals to a CI range of 6.32% compared to mean λ at 0.693...

Estimation of number of copies of the target molecule in the whole well:

$$8500 \times (0.671...0.693...0.715) = (5707...5892...6080)$$

Absolute quantification – copies per microliter

Based on the known number of copies of the target molecule per partition (λ) and the partition volume, the copies per microliter can be calculated using the tripartite calculation.

$$\Lambda_{\text{volume}} = \frac{\lambda}{V[\mu\text{L}]}$$

Example:

The number of copies of the target molecule is $\lambda = 0.693$.

The estimated partition volume is $V = 0.34$ nL.

The copies per microliter is:

$$\lambda_{\text{volume}} = \frac{0.693}{0.34} \times 1000 = 2038 \text{ copies}/\mu\text{L}$$

The 2038 copies/ μL is the concentration, which is the standard readout in the dPCR results. To calculate the copies of the target molecule in the reaction volume, you multiply by the input reaction volume. In case the input reaction volume is 12 μL , the copy number in the input reaction is $2038 \times 12 = 24,456$ copies.

Replicates

Replicates are analyzed as separate wells but in addition the mean concentration value and the CI value of the mean concentration are provided on demand.

On the right side above the table, there is a checkbox that allows the user to show mean values for replicates in addition. By default, the button is unchecked and results are displayed without mean values. When the button is checked, the list still shows independent rows for each selected well but replicates are grouped together. Replicates from the same group are next to each other in the list view.

Add to report
 Show mean values for replicates

Sample/NTC/Control	Reaction Mix	Name	Channel	IC	Control	Conc. cp/μL	CI (95%)	Mean conc. cp/μL	CI (95%)	SD	CV%	Valid	Partitions Positive	Negative	Threshold
A2	101 Inq gDNA	DPH218 ERBB2 + DPH186 TERT Ref. channel: ○ Std-Ref	● Green	-	-	26.51	23.4%	26.59	20.5%	2.192	8.24%	8240	70	8170	63.11
A3	101 Inq gDNA	DPH218 ERBB2 + DPH186 TERT Ref. channel: ○ Std-Ref	● Green	-	-	28.82	22.5%	26.59	20.5%	2.192	8.24%	8255	76	8179	61.20
A4	101 Inq gDNA	DPH218 ERBB2 + DPH186 TERT Ref. channel: ○ Std-Ref	● Green	-	-	24.44	24.5%	26.59	20.5%	2.192	8.24%	8210	64	8146	73.95

Example screenshot taken from the QIAcuity Software Suite showing results for replicates with three wells: A2, A3, and A4.

Mean concentration

Mean concentration for replicates is calculated as a weighted average for concentrations for individual replicates. Weights are the well-specific volume of a single partition within a well, which can be calculated as a volume of the whole well divided by the total number of partitions.

$$\text{Formula for mean concentration (cp per } \mu\text{L) of 2 replicates} = \frac{c(1) \times v(1) + c(2) \times v(2)}{(v(1) + v(2))}$$

Example for mean concentration:

$$(\text{cp per } \mu\text{L) of 2 replicates} = \frac{(472.2 \times 0.757 + 505.1 \times 0.749 + 478.1 \times 0.749)}{0.757 + 0.749 + 0.749} = 485.09 \text{ cp}/\mu\text{L}$$

CI (95%) – CI of mean concentration assumes that error between individual results has normal distribution. t_{n-1} is defined as critical value of Student's t distribution for 95% and number of degrees of freedom equal number of replicates minus 1.

$$\text{CI for replicates} = \text{mean weighted by partition volume} \pm t_{n-1} \times \frac{\text{Standard deviation of the replicate set}}{\sqrt{n}}$$

n is the number of replicates, three in our example. The critical value for the appropriate t distribution is $t_{n-1} = t_2 = 4.303$. The factor $\frac{t_{n-1}}{\sqrt{n}}$ can be seen as a factor by which the standard error for the replicates is larger than the standard deviation of the concentrations in the observed set of replicates. The factor is fixed for a given number of replicates. In this example, with three replicates, the factor is $\frac{t_{n-1}}{\sqrt{n}} = \frac{4.303}{1.7320508} = 2.48434$. We calculate the standard deviation of the replicate set using the formula for sample:

$$\text{Standard deviation of the replicate set} = \sqrt{\frac{\sum (a_i - \bar{c})^2}{n-1}}$$

Standard deviation

$$\text{Example for the standard deviation} = \sqrt{\frac{(472.2-485.09)^2 + (505.1-485.09)^2 + (478.1-485.09)^2}{3-1}} = 17.5416$$

Coefficient of variation

Coefficient of variance is a ratio of Standard deviation to Mean concentration for replicates, expressed in %:

$$\text{Formula for coefficient of variation of 2 replicates} = \frac{\text{standard deviation}}{\text{mean concentration}} 100\%$$

$$\text{Example for coefficient of variation of 2 replicates} = \frac{17.5416}{485.0876} 100\% = 3.616\%$$

Setting up an absolute quantification analysis

1. Click the applicable wells in the plate layout. For more information, refer to "Selecting wells for analysis".

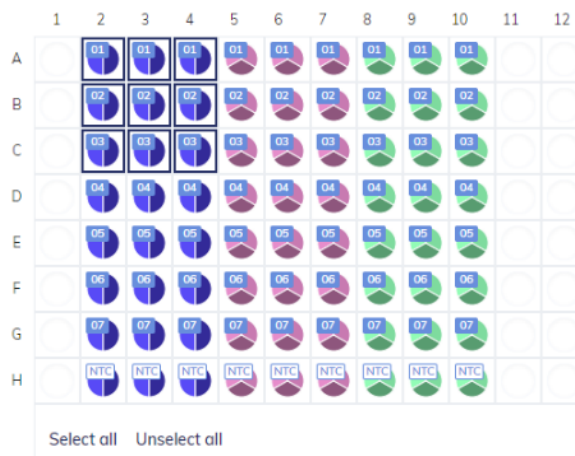

2. To select the analysis type, click **Target** or **Channel**.

Note: If there are no reaction mixes available on the plate, the **Target** button is disabled.

3. To analyze the plate by targets, select the targets from the Select Targets list. User can select one or more targets from the list. To select all targets, click **Select all**.

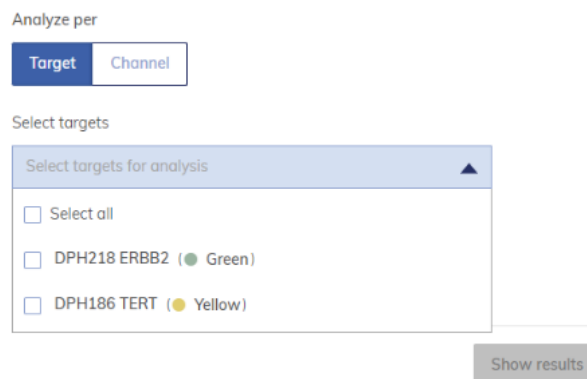

Note: If amplitude multiplexing is enabled, associated targets are disabled for a target-based analysis. Only a channel-based analysis is supported.

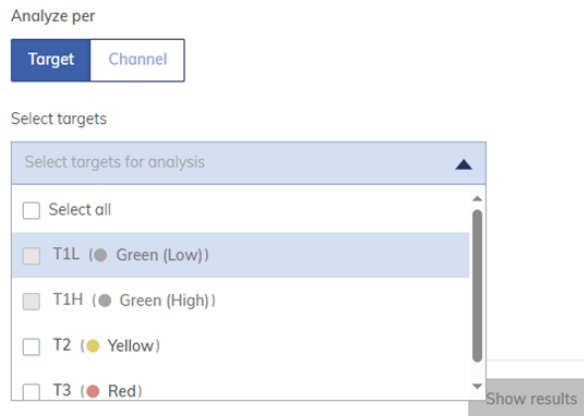

Example of enabled amplitude multiplexing for the Green channel. Associated targets are disabled for a target based analysis.

4. Select **Horizontal** or **Vertical** wells results presentation.

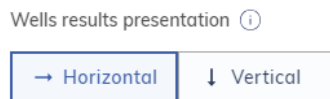

5. Click **Show results** to view the results of the analysis.
6. To analyze the plate by channels, check the boxes of the corresponding channel color to select the relevant channels. If images are not taken for a channel, the channel becomes disabled.

Note: In analysis per Channels, only channels selected during Imaging are available and channels assigned to selected wells are preselected by default (checkboxes checked).

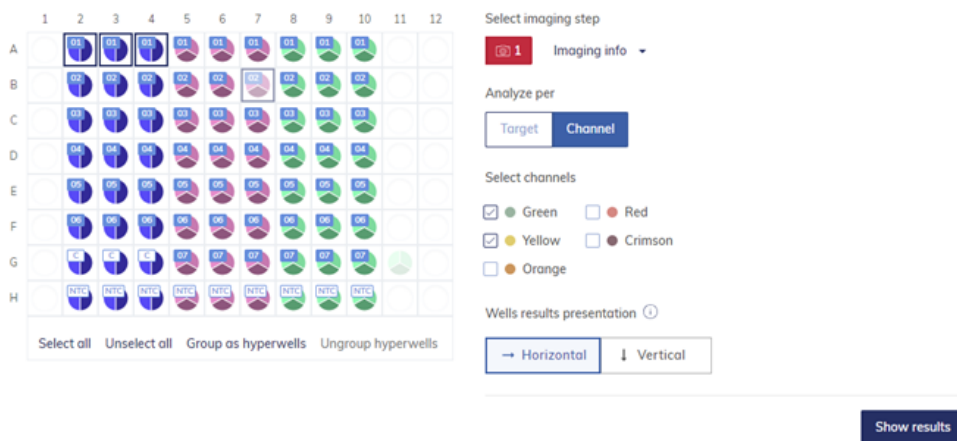

7. Select **Horizontal** or **Vertical** wells results presentation.
8. Click **Show results** to view the results of the analysis.
9. The results are divided into several tabs. To view the contents of the tab, click the tab title.

Note: For the result analysis at least one well and a target or channel must be selected.

List tab for absolute quantification

The **List** tab contains a table with an overview of the analyzed wells. The following columns are available in the table:

1. **Well ID** – Like A1, B2, when gradient cycling was selected, there is also temperature in the well (temperature range instead of single one, if hyperwells were selected)
2. **Sample/NTC/Control** – This column shows the sample, NTC, or control name with its corresponding icon that identifies the sample or indicates whether the entry is an NTC or control.
3. **Reaction mix** – This column contains the icon and the name of the reaction mix, and reference channel that has been detected (Std-Ref or HM-Ref).
4. **Target or Channel** – Depending on the settings defined when selecting a source, this column shows the target or channel names and its corresponding color.

Note: If amplitude multiplexing mode is enabled, the list view of the channel-based analysis is enlarged into Low and High results of associated channel/s.

5. **Conc. [copies/μL]** – This column shows the concentration assigned to each target or channel per well.
6. **CI (95%)** – This column shows the value of the confidence interval at a 95% confidence level for concentration.
 - a. When checkbox “Show mean values for replicates” is checked, additional three columns are displayed:
 - **Mean conc. [copies/μL]** – This column shows the mean concentration assigned to each target or channel per well for replicates.
 - **CI (95%)** – This column shows the value of the confidence interval at a 95% confidence level for the mean concentration.
 - **SD** – This column contains standard deviation of concentration for replicates.
 - **CV%** – This column shows coefficient of variance in percentage of the concentration for replicates.

Note: Columns Conc., CI (95%), and columns related to Mean conc. CI will be additionally divided into several sub-columns, depending if dilution and/or conversion function (described in sections “Dilution calculation option” and “Conversion factor”, accordingly) have been selected.

7. **Partitions (Valid, Positive, Negative)** – This column shows the number of valid, positive, and negative partitions per well and the target or channel.
8. **Threshold** – This column shows the current threshold.

Note: When polygon (for threshold setting) was used, “variable” is displayed instead of threshold value.

Note: When amplitude multiplexing is enabled, three threshold values are presented in following order: double positive, high threshold, and low threshold per each row.





Well	Sample/NTC/Control	Reaction Mix	Channel			Concentration		Partitions			Threshold
			Name	IC	Control	dPCR Reaction		Valid	Positive	Negative	
						cp/μL	CI (95%)				
A10	Sample1	CXTM_Suite_VER_TC1_96LV Ref. channel: HM-Ref 	● Green (Low)	-	-	6.608	47.5%	8031	17	8014	36.72 29.62 21.04
			● Green (High)	-	-	191.4	9.0%	8031	478	7553	36.72 29.62 21.04

Example screenshot taken from the QIAcuity Software Suite showing how AM split on channel Green impacts List.





Note: Saturated signals are marked with a  symbol next to the concentration value in the list view. Furthermore, a dedicated information message is shown above the diagram. For more information regarding saturated signals, refer to “Image quality control” section.

Note: Reaction mixes without advised custom cross talk matrix are marked with  symbol in the list view. Furthermore, a dedicated information message is shown above the diagram. For more information, refer to section “Custom cross talk matrix”.

Export to CSV

List											
Signalmap Heatmap Histogram 1D Scatterplot 2D Scatterplot Concentration diagram											
<input type="checkbox"/> Add to report <input type="checkbox"/> Show mean values for replicates  Export to CSV...											
Well	Sample/NTC/Control	Reaction Mix	Channel			Concentration		Partitions			Threshold
			Name	IC	Control	dPCR Reaction	CI (95%)	Valid	Positive	Negative	
A9	Sample1	 CXTM_Suite_VER_TC1_96LV Ref. channel: HM-Ref 	Green (Low)	-	-	3.074	69.3%	8094	8	8086	36.30 27.53 11.67
			Green (High)	-	-	181.5	9.1%	8094	459	7635	36.30 27.53 11.67
			Yellow	-	-	228.4	8.2%	8100	574	7526	38.89
A10	Sample1	 CXTM_Suite_VER_TC1_96LV Ref. channel: HM-Ref 	Green (Low)	-	-	6.997	46.2%	8031	18	8013	36.30 27.53 11.67
			Green (High)	-	-	195.9	8.9%	8031	489	7542	36.30 27.53 11.67
			Yellow	-	-	227.5	8.2%	8031	565	7466	31.88

Besides displaying the table with results, there is an additional option in **List** tab to export results of analysis to CSV file that can be saved on hard drive.

List												
Signalmap Heatmap Histogram 1D Scatterplot 2D Scatterplot Concentration diagram												
<input type="checkbox"/> Add to report <input type="checkbox"/> Show mean values for replicates  Export to CSV...												
Well	Sample/NTC/Control	Reaction Mix	Channel			Concentration		Partitions			Threshold	
			Name	IC	Control	dPCR Reaction	CI (95%)	Valid	Positive	Neg		
A9	Sample1	 CXTM_Suite_VER_TC1_96LV Ref. channel: HM-Ref 	Green (Low)	-	-	3.074	69.3%	8094	8		36.30 27.53 11.67	
			Green (High)	-	-	181.5	9.1%	8094	459	7635		36.30 27.53 11.67
			Yellow	-	-	228.4	8.2%	8100	574	7526		38.89
A10	Sample1	 CXTM_Suite_VER_TC1_96LV Ref. channel: HM-Ref 	Green (Low)	-	-	6.997	46.2%	8031	18	8013	36.30 27.53 11.67	
			Green (High)	-	-	195.9	8.9%	8031	489	7542		36.30 27.53 11.67
			Yellow	-	-	227.5	8.2%	8031	565	7466		31.88

Current results

Multiple occupancy

RFU values

RFU values (compact)

Current results

To export current results of analysis, follow the instruction below.

1. Select the wells that user wants to get results for.
2. Choose whether to analyze per target or per channel by clicking the proper tab, and select targets or channels that the user is interested in.
3. Select **Horizontal** or **Vertical** wells results presentation.
4. Click the **Show results** button.
5. In the **List** tab, above the table, on the right-hand side, the **Export to CSV...** option is available.
6. Click the **Export to CSV...** option and select the **Current results** option.
7. Remember that data in CSV reflect data from List view are structured as follows:

- Plate name – name of the plate
- Plate ID – unique identifier of the plate
- Plate type – type of the plate
- Well – identifier of well
- Hyperwell – identifier of hyperwell
- Sample/NTC/Control – name of Sample/NTC/Control
- Type – Type (Sample/Control/Non Template Control)
- Reaction Mix – name of reaction mix
- Channel (name)/Target (name)– abbreviation of channel name or target name, respectively.

Note: When amplitude multiplexing is enabled, additional suffix “L” or “H” representing “Low” or “High” part of channel is added to channel abbreviation.

- IC – internal control if selected
- Conc. [cp/μL] (dPCR reaction) – calculated concentration in dPCR reaction
- Conc. [unit] (dPCR reaction) – converted concentration in dPCR reaction, in user-defined unit
- CI (95%) (dPCR reaction) – confidence interval parameter in dPCR reaction
- Conc. [cp/μL] (undiluted sample) – calculated concentration in undiluted sample
- Conc. [unit] (undiluted sample) – converted concentration in undiluted sample and in user-defined unit
- Mean conc. [cp/μL] (dPCR reaction) – calculated mean concentration in dPCR reaction of replicates
- Mean conc. [unit] (dPCR reaction) – converted mean concentration in dPCR reaction in user-defined unit of replicates
- CI (95%) (dPCR reaction) – confidence interval parameter for mean concentration in dPCR reaction in custom unit of replicates
- Mean conc. [cp/μL] (undiluted sample) – calculated mean concentration in undiluted sample
- Mean conc. [unit] (undiluted sample) – converted mean concentration in undiluted sample and in custom unit for replicates

- SD [cp/μL] (dPCR reaction) – calculated standard deviation of concentration for replicates in dPCR reaction
- SD [ng/μL] (dPCR reaction) – converted standard deviation of concentration for replicates in dPCR reaction in custom unit
- SD [cp/μL] (undiluted sample) – calculated standard deviation of concentration for replicates in undiluted sample
- SD [ng/μL] (undiluted sample) – converted standard deviation of concentration for replicates in undiluted sample in user-defined unit
- CV% – calculated coefficient of variance of concentration for replicates
- Partitions (Valid) – number of valid partitions
- Partitions (Positive) – number of positive partitions
- Partitions (Negative) – number of negative partitions
- Threshold – value(s) of single threshold or three thresholds (double positives, high, and low) when amplitude multiplexing mode is enabled
- Volume per well [μL] – cycled volume per well, includes VPF if applied
- Temperature gradient [°C] – temperature in well (range for hyperwells) if gradient cycling used
- Concentration factor – value of concentration factor given by user during sample creation
- Template volume [μL] – value of template volume given by user during sample creation
- Total volume [μL] – value of total volume given by user during reaction mix creation
- Conversion factor – value of conversion factor given by user during sample creation
- Conversion unit – conversion factor's unit given by user during sample creation
- REF – type of detected Reference channel. Standard Reference channel (Std-Ref) or High-Multiplexing Reference channel (Std-Ref or HM-Ref)
- CXT matrix RM template name – if reaction mix with CXTM was assigned to this well, this column shows name of the reaction mix template on which that reaction mix was based.
- CXT matrix RM template ID – if a reaction mix with CXTM was assigned to well, this column shows the ID of the reaction mix template on which that reaction mix was based.

Multiple occupancy

For multiple occupancy exports for multiplex reaction:

1. Select the wells that need to get the results for.
2. Choose whether to analyze per target or per channel by clicking proper tab, and select targets or channels that the user is interested in.
3. Select **Horizontal** or **Vertical** wells results presentation.
4. Click the **Show results** button.
5. In the **List** tab, above the table, on the right-hand side, you can see the **Export to CSV...** option.
6. Click the **Export to CSV** option and select the **Multiple occupancy** option.

7. Use the checkboxes to specify group/s, that should be presented in CSV.

The number preceding the word "positives" determines the amount of positives ("+") in all possible combinations in file. For example, in a 3-plex reaction mix, all possible combinations with only 1 positive are "+--", "-+-", and "---". The groups "All positives" and "All negatives" represent combinations with only positives (only "+") and only negatives (only "-"). So in the 3-plex example, it is "+++" and "---" accordingly.

Multiple occupancy ×

Select group/s you want to export.

Select all

Positives

- All positives
- 1 positive
- 2 positives
- 3 positives
- 4 positives
- 5 positives
- 6 positives
- 7 positives
- 8 positives

All negatives

Important: There is a limitation in the system that maximal amount of selected targets/channels is 8. When this limit is exceeded, below error is presented, CSV is not generated and user has to change source selection:

Export Multiple Occupancy Error ×

For multiple occupancy export, the number of selected channels exceeds the maximum limit of 8. Please adjust your selection to meet this requirement.

8. When CSV file is generated successfully, the data are structured as follows:

- Plate name – name of the plate
- Plate ID – unique identifier of the plate
- Plate type – type of the plate
- Well – identifier of well
- Hyperwell – identifier of hyperwell if wells were grouped
- Reaction Mix name – name of reaction mix
- Sample name – name of sample
- Target names – name of targets in reaction mix
- Categories – abbreviations of channel names associated with targets in reaction mix

Note: When amplitude multiplexing is applied in this CSV, "H" or "L" suffix is used for target High or target Low, respectively.

- Group – identifier of a specific combination of channels, represented as a sequence of either positive (+) or negative (-) symbols for each channel
- Valid partitions – total number of valid partitions in a well
- Volume per well [μL] – cycled volume per well (VPF file dependent)
- Count categories – number of valid partitions in a certain group
- Count random – the theoretical number of partition being positive in all selected channels ("++...+") in the well that statistically are related to random filling of molecules from groups not creating a signal in all selected channels ("++...+") but do not containing target molecules which are fully linked and thereby would create a signal in all selected channels anyway. For example, for fully linked target molecules, the count random value should therefore be rather small compared to the overall number of full positive partition ("++...+") and for none linked targets rather as many as the observed amount of full positive partition ("++...+") count.
- Random variation – standard error of count random
- Lambda – expected number of target molecules within a single partition per group
- Lambda error – standard error of the Lambda
- Conc. Per group [$\text{cp}/\mu\text{L}$] – expected number of target molecules per microliter per group
- Conc. Per group error – standard error of Conc. Per group [$\text{cp}/\mu\text{L}$]
- Concentration factor – value of concentration factor defined during sample creation
- Template volume [μL] – value of sample template volume defined during sample creation
- Total volume [μL] – value of total reaction mix volume per well defined during reaction mix creation
- Undiluted Conc. Per group [$\text{cp}/\mu\text{L}$] – value of concentration of certain group in undiluted sample taking concentration factor into account, if defined
- Undiluted Conc. Per group [$\text{cp}/\mu\text{L}$] error – standard error of Undiluted Conc. per group [$\text{cp}/\mu\text{L}$]
- Conversion factor – value of conversion factor defined during sample creation
- Conversion factor unit – conversion factor's unit defined during sample creation
- Conv. Undiluted Conc. Per group – converted value of concentration of certain group, in defined unit in undiluted sample taking concentration & conversion factor into account, if defined
- Conv. Undiluted Conc. Per group error – standard error of the Conv. Undiluted Conc. Per group
- % intact – % ratio of the concentration of target molecules for full positive group divided by concentration of all molecules from all groups
- % intact error – standard error of %intact
- Mean Random – mean value for Count random parameter for replicates
- Mean Lambda – mean value for Lambda value for replicates
- SE Mean Lambda – standard error for Mean Lambda
- Mean Clean Conc – mean value for Conc. Per group value for replicates

- SE Mean Clean Conc – standard error for Mean Clean Conc.
- Mean % intact – mean value for % intact value for replicates
- SE Mean % intact– standard error for Mean % intact
- Mean Undiluted Conc. – mean value for above Undiluted Conc. Per group parameter for replicates
- SE Mean Undiluted Conc. – standard error for Mean Undiluted Conc.
- Mean Conv. Undiluted Conc. – mean value for Conv. Undiluted Conc. Per group parameter for replicates
- SE Mean Conv. Undiluted Conc. – standard error for Mean Conv. Undiluted Conc.
- CXT matrix RM template name – if Reaction Mix with CXTM was assigned to well this column shows name of RM template on which that RM was based
- CXT matrix RM template ID - if Reaction Mix with CXTM was assigned to well this column shows ID of reaction mix template on which that reaction mix was based

Note: To not duplicate the same data in CSV, same data in subsequent rows of one well are displayed only once.

RFU values

If you want to export relative fluorescence units per partitions for selected wells, follow the instructions below.

1. Select the wells that user wants to get results for.
2. Click the **Channels** tab, and select channels you are interested in.
3. Click the **Show results** button.
4. In the List tab, above the table, on the right-hand side, the **Export to CSV...** option is available.
5. Click the **Export to CSV...** option and select the **RFU values** option.
6. Remember that the data in CSV are structured as follows:
 - Plate name – name of the plate
 - Plate ID – unique identifier of the plate
 - Plate type – type of the plate
 - Well – identifier of well
 - Sample – identifier of sample
 - Channel – first letter of channel on which picture was taken

Note: When amplitude multiplexing is used, “H” or “L” suffix is added for High or Low target indicator, respectively.

 - Cycled volume (µL) – well volume corrected by VPF
 - Threshold – threshold value
 - Partition – number by which a partition can be identified
 - Is Invalid – code for invalidation reason (check mapping table code statuses, there can be a maximum three codes separated by a comma)

In case amplitude multiplexing is applied, the following columns are additionally available:

- Threshold low – replaces Threshold by threshold low value
- Threshold high – threshold high value
- Threshold double – threshold double value
- Classification –if partition is valid (RFU is filled), it shows whether partition is positive, negative, or double (positive); otherwise, N/A is presented:
 - In files with suffix “L”
 - If the partition’s RFU greater than the Threshold double value, the column displays “double”.
 - If the Threshold low value less than the partition’s RFU and the partition’s RFU is less than Threshold high value, the column displays “positive”.
 - If the partition’s RFU is less than the Threshold low value or the Threshold high value is less than the partition's RFU and the partition’s RFU is less than the Threshold double value, the column displays “negative”.
 - In files with suffix “H”
 - If the partition’s RFU is greater than the Threshold double value, the column displays “double”.
 - If the Threshold high value is less than the partition’s RFU and the partition’s RFU is less than the Threshold double value, the column displays “positive”.
 - If the partition’s RFU is less than the Threshold high value, the column displays “negative”.

Status	Code
Poisson test – linear distribution issue Blistering (Poisson test)	1
Poisson test areas of too low/no positive partitions amplification)	2
Poisson test areas of too high positive partitions (Proportion test – over-amplification)	3 & 4
Reference partition not filled	5 & 9
Dust detected by different reasons	6, 7, 8
Artifacts founds	B & C

- IsPositive – information whenever a partition was marked as positive or double positive (1) or negative (0). For invalid partitions there is no information presented
- RFU – RFU values associated with partition. For invalid partitions there is no information present
- REF – type of detected Reference channel (Std-Ref or HM-Ref)

7. The data will be exported to separate CSV files (one for each selected channel) and compressed into one zip file.

Note: When amplitude multiplexing is applied two separate files for Low (suffix “L”) and High (suffix “H”) part are created.

Note: Be informed that due to some corrections provided by analysis models, sometimes there might be changes when comparing IsPositive column values with information obtained by comparing RFU values to threshold.

RFU values (compact)

This option is very similar to regular RFU report but redundant data in columns: Well, Sample, Channel, and Cycled volume in CSV file are removed to decrease the file size — same names or values in subsequent rows will only be shown once until the name of value has changed.

Importing of exported CSV file to Microsoft Excel

To correctly import previously exported CSV into Microsoft Excel without any data loss, it is strongly recommended to use following option: from **Data** menu, select option **From Text/CSV**, then browse for correct file and click **Load** in newly opened window.

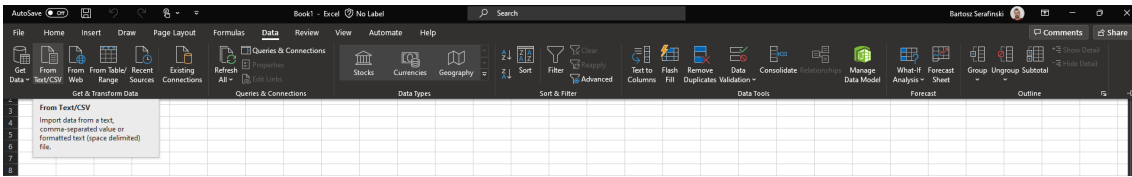

It is strongly recommended to check/adapt the column type for the result data to Decimal Number.

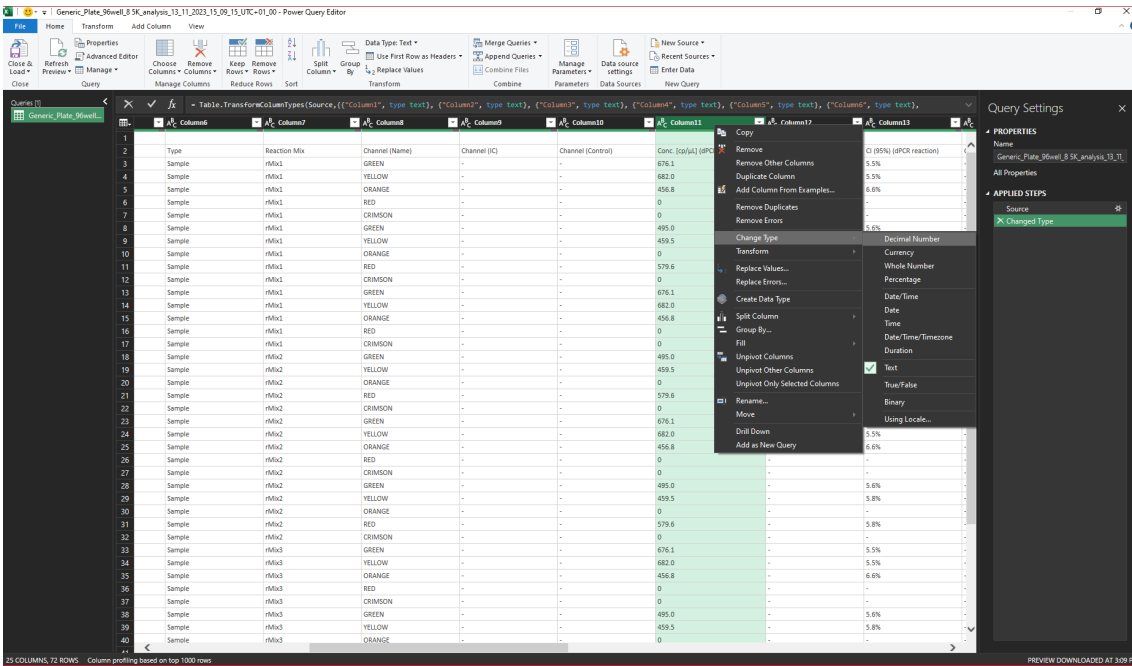

Signalmap tab for absolute quantification

The **Signalmap** tab provides the view that allows to differentiate positive partitions for target channels and valid partitions for the reference channel of selected wells. For each channel included in target or channel selection, one signal map view is created. The signal map views are sorted by channel position in imaging, separated by a horizontal line.

With this view, the user can visually check the influence of threshold settings on the partition distribution and consider the impact of artifacts that might have been discovered in the source image view.

Each signal map represents the plate layout for a selected channel where only the images of the selected wells are loaded. Remaining wells are displayed as gray squares. When the image of a well could not be calculated by the algorithm, a placeholder image is shown. On hovering the mouse over the well, the user is informed that the signal map for this well could not be created.

The title of a signal map shows the channel name and, in case that more than one well is selected, the number of selected wells.

When the user hovers with the mouse over a well, a tooltip is shown informing about the label of the given well, detected reference channel, and, in analysis per target, the associated target. On hovering the well image, the image is highlighted and the cursor changes to the zoom icon – user can click and enlarge the well.

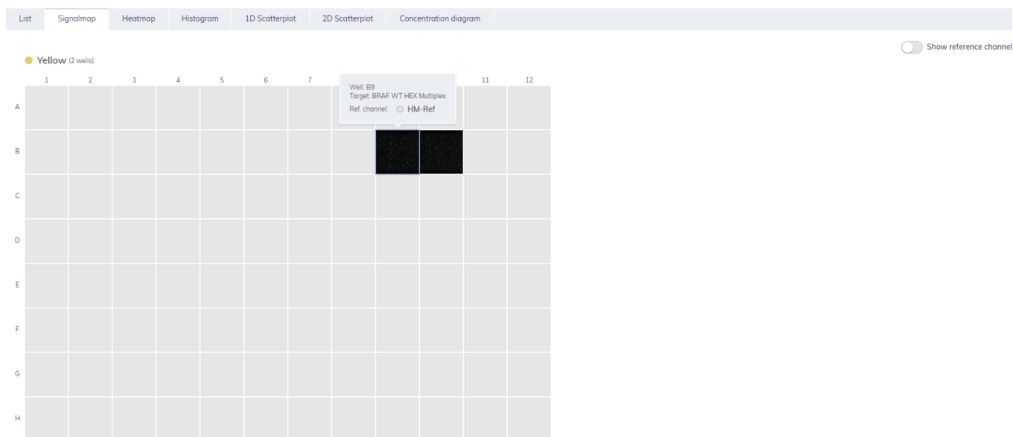

Signal map for a target channel.

On mouse-click, a modal window opens containing the well image providing the following tool options on top of the right side.

1. Zoom In
2. Zoom out
3. Download signal map of this well as picture
4. Close zooming window

The Zoom-In and Zoom-Out feature is also possible using the mouse wheel. On top of the left side, the well ID, channel name, and if defined the associated target name are shown. Below the signal map, there is a legend with color's description – positive partitions are always marked with green dots independently of channel.

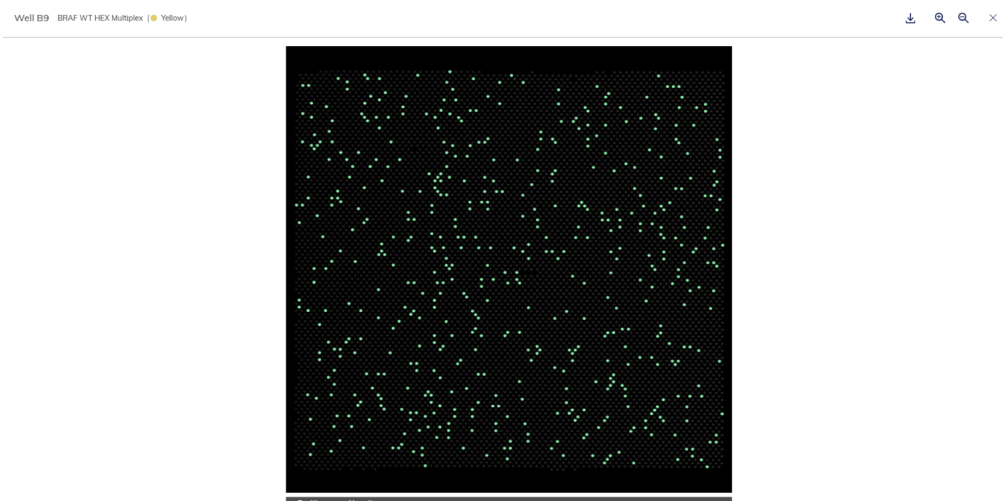

Enlarged signal map for a target channel Yellow with assigned target.

When amplitude multiplexing split is enabled, on enlarged view of particular well, partitions that are positive for channel low, positive for channel high, double positives, or negatives can be distinguished. Below the signal map, there is a legend with the color's description.

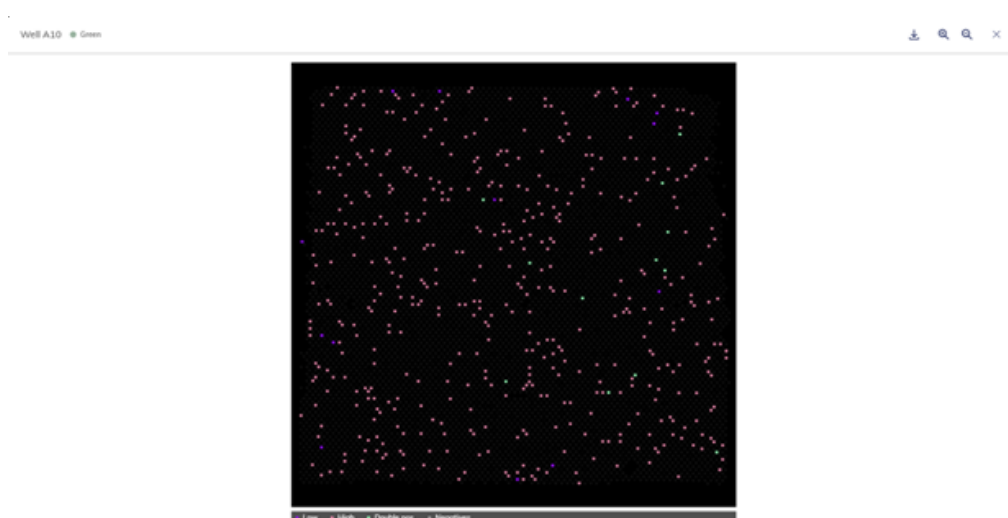

Signal map for enlarged well when amplitude multiplexing is applied.

The Software Suite provides a signal map view for the reference channel, which is hidden by default. To view the signal map for the reference channel in addition, click **Show reference channel**. The functionality of the signal map view for the reference channel is analog to the signal map views of the target channels but shows partitions that are marked with blue dots.

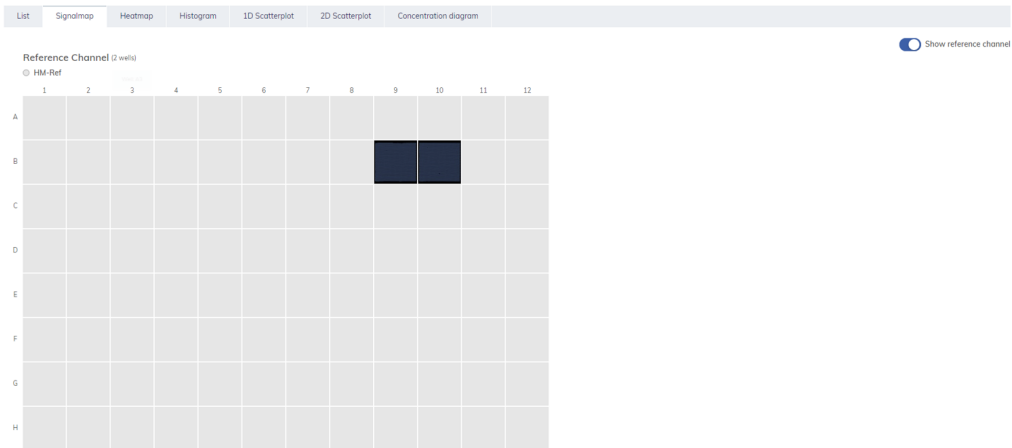

Signal map for a reference channel.

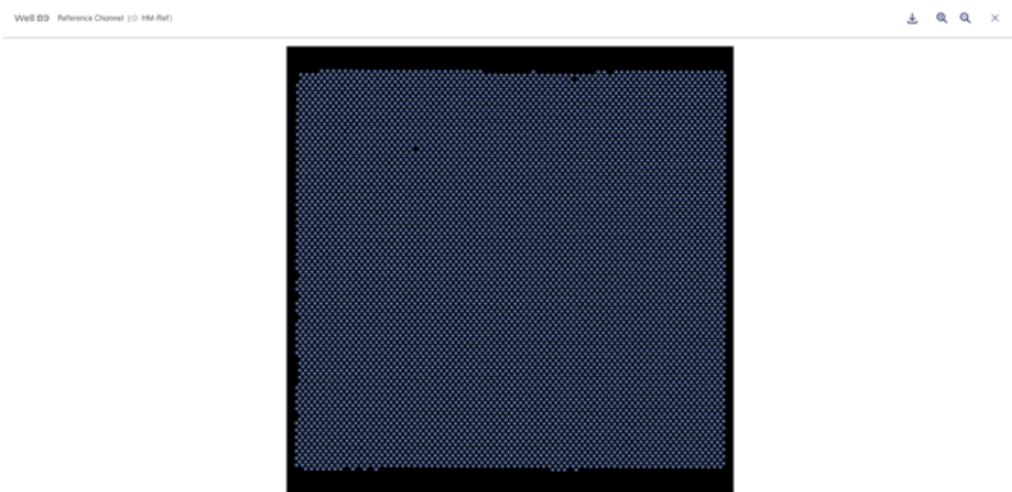

Enlarged signal map for a reference channel.

Heatmap tab for absolute quantification

The **Heatmap** tab shows the concentration of the selected targets or channels in each well. The values of all selected wells are also displayed in this tab. Values for disabled wells are not displayed. One heatmap view is created for each selected target or channel. The heatmap views are sorted by channel position in imaging ("Green", "Yellow", "Orange", "Red", "Crimson"), separated by a horizontal line.

When amplitude multiplexing is applied, separate heatmaps are generated for "Low" and "High" part of the channel.

If the target or channel shown in a heatmap is not relevant to one or more wells, those wells do not have a value displayed and their background color is gray.

Move the pointer over a well getting further detailed information of the corresponding well.

To view an additional toolbar that enables downloading the plot, hold the pointer over the diagram.

There are two views of each heatmap – the concentration view and the partitions view (see the following images). To switch between the views, click **Concentration** or **Partitions**. There are several additional options that user can select:

1. **Use sample dilution** – as described in section “Dilution calculation option”, enables calculations related to dilution factor. Results in undiluted sample is additionally presented on well tiles. Option is available both on concentration view and partition view.
2. **Use conversion factor** – enables conversion of results into unit given by user (described in section “Conversion factor”). Results in converted unit replace standard ones on well tiles. Option is only available in the concentration view (not supported in the partition view).
3. **Show mean values for replicates** – showing the mean concentration values for replicates in the concentration view (not supported in the partition view).

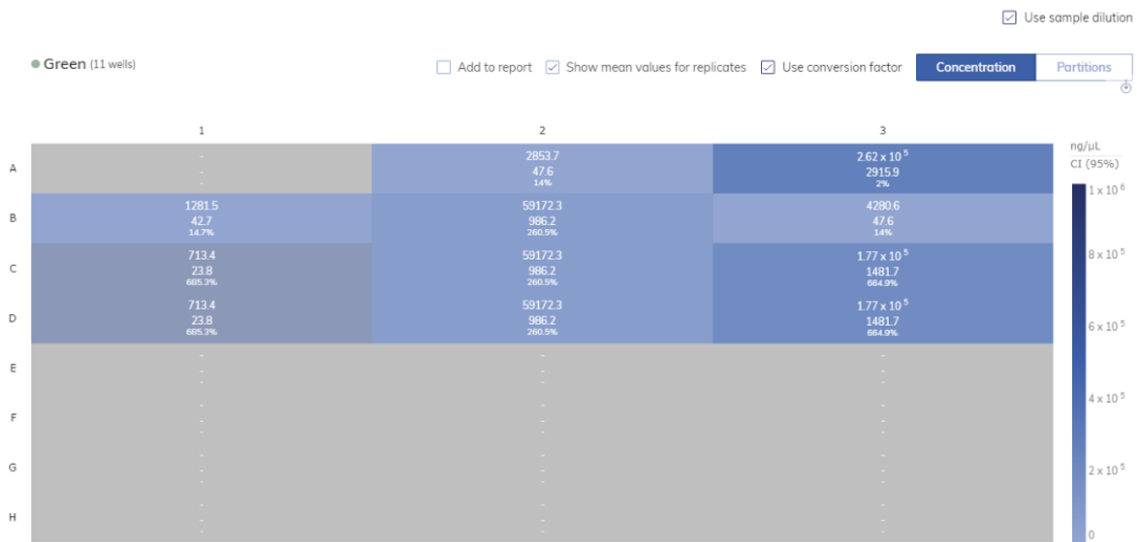

The concentration view for heatmap of a selected target (with selected mean values for replicates, conversion, and dilution factors).

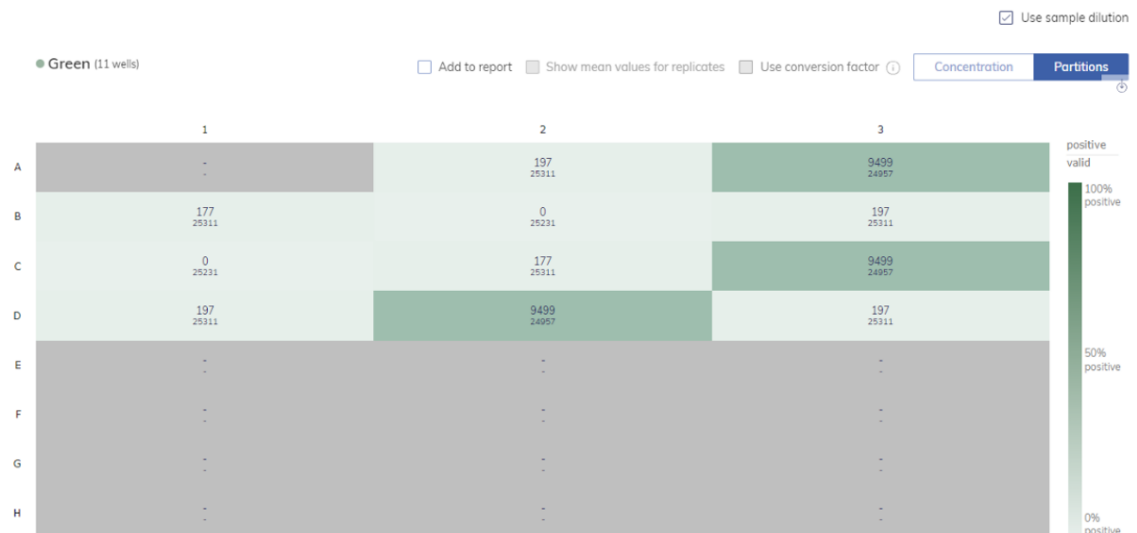

The partitions view for heatmap of a selected target.

To add any of the heatmaps to the report, click **Add to report** next to the relevant diagram. For more information on reports, see section “Reports”.

Heatmap for hyperwells

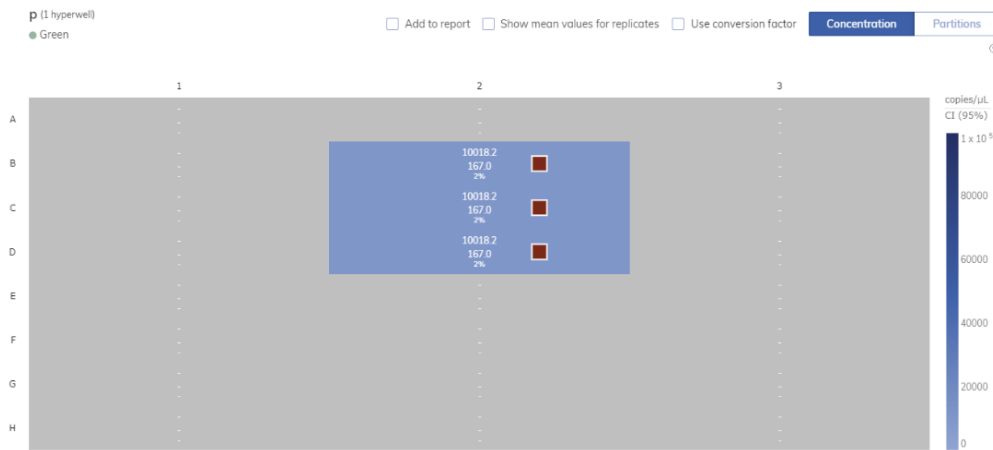

Histogram tab for absolute quantification

The **Histogram** tab displays graphs that visualize the fluorescence values of selected wells for the selected target or channel. One histogram view is created for each selected target or channel. The histograms are sorted by channel position in imaging (“Green”, “Yellow”, “Orange”, “Red”, “Crimson”), separated by a horizontal line.

Each histogram has two axes. The x axis represents the relative fluorescence intensity. The y axis represents the number of partitions having that fluorescence intensity. The values on the y axis have two available scales that can be selected using one of the buttons located below each graph: **lin** for linear or **log10** for logarithmic scale.

Furthermore, the user can change the range of the x axis by modifying the upper value of the fluorescence intensity on the x axis. The view of the histogram is adapted accordingly. Resetting the x axis to the default range is provided by using the related **Reset Axes** icon of the tool bar.

To view an additional toolbar that enables actions related to the diagram, such as downloading the plot, zoom, and pan, hold the pointer over the diagram. For more details about the toolbar, refer to section “Diagram options”.

The Threshold field shows the threshold value of the fluorescence intensity that is used to distinguish between positive and negative calls. If only one source well is selected, the value of the threshold is shown in the Threshold field and on the graph as a red line. If multiple source wells are defined and their automatically calculated threshold values are different, a threshold value is initially not shown in the histogram.

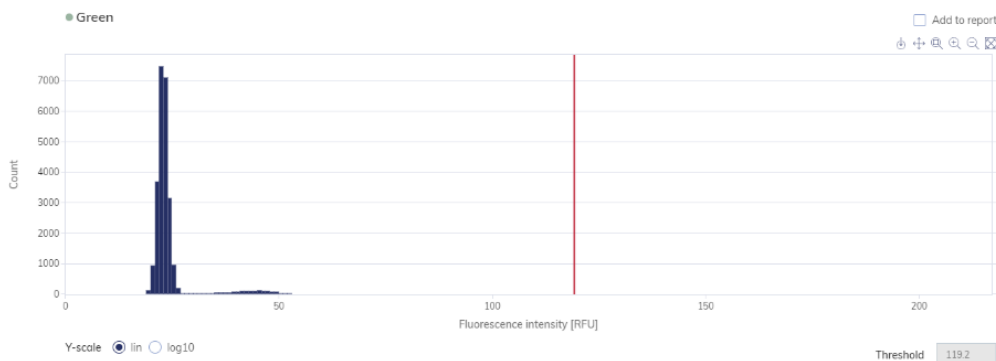

The Histogram tab.

To add any of the histograms to the report, click **Add to report** next to the relevant diagram. For more information on reports, see section "Reports".

Reference channel on histogram

The Software Suite also provides a histogram for the reference channel, which is hidden by default. To view the histogram for the reference channel in addition, click **Show reference channel**. The title of this histogram indicates that the histogram is related to the reference channel.

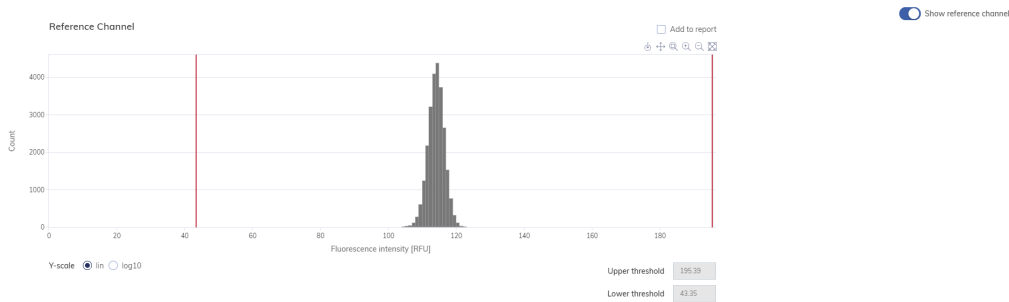

1D Scatterplot tab for absolute quantification

The **1D Scatterplot** tab shows one 1D Scatterplot view for each analyzed target or channel. If there are more than one scatterplot views, they are separated with a horizontal line. The 1D Scatterplot views are sorted by channel position in imaging ("Green", "Yellow", "Orange", "Red", "Crimson", "Far red").

The title of a 1D Scatterplot view shows the related channel name including the dot channel color indicator and, if defined, the target name. If more than one well is selected also the number of wells is shown.

Thus, a 1D Scatterplot view has two axes. The x axis represents the analyzed partitions, while the y axis represents the relative fluorescence intensity of each partition.

Note: For RFU values below 60, it is recommended to increase the exposure time of corresponding channel/s, and for RFU values above 150, it is recommended to decrease the exposure time of corresponding channel/s.

A 1D Scatterplot view concentrates the diagrams for each selected well in a horizontal way separated by a vertical line (column indicator). For each well diagram, a header is shown indicating the well coordination on the plate, sample name assigned to that well, reference channel detected by Algorithm (Std-Ref or HM-Ref), and temperature of this well if temperature gradient cycling was used. A red line represents the current threshold fluorescence intensity value (decimal value) that is used to distinguish between positive and negative partitions. Fluorescence values below the threshold are shown in gray, above the threshold in blue color.

User is able to select how many wells are presented per row using drop-down menu – 8, 12, 16 (by default), 20, or 24. Width of each well will depend on selected option and screen resolution.

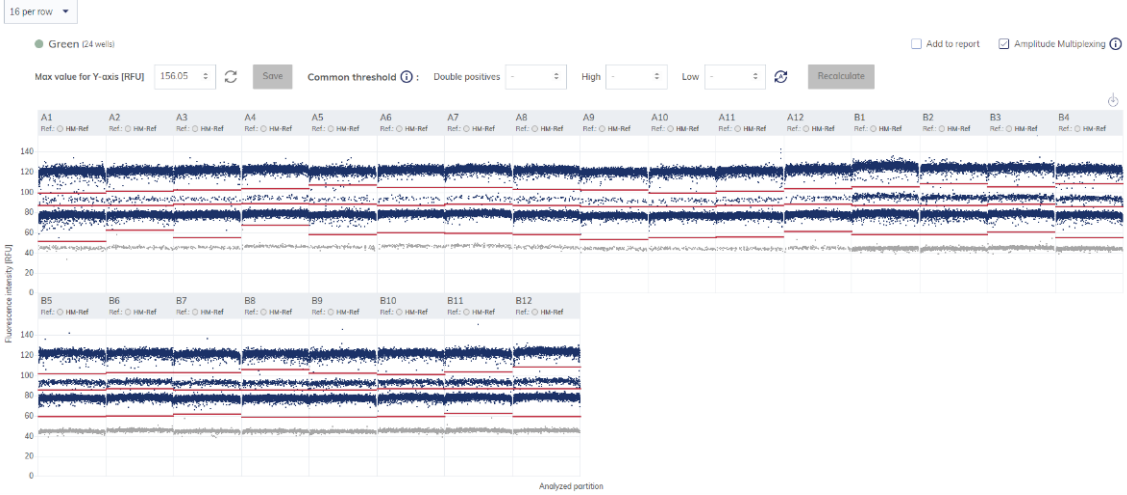

Example of 1D Scatterplot with enabled temperature gradient and 16 wells per row.



Example of 1D Scatterplot of hyperwells.

To open an individual plot, click the appropriate header of the 1D Scatterplot.

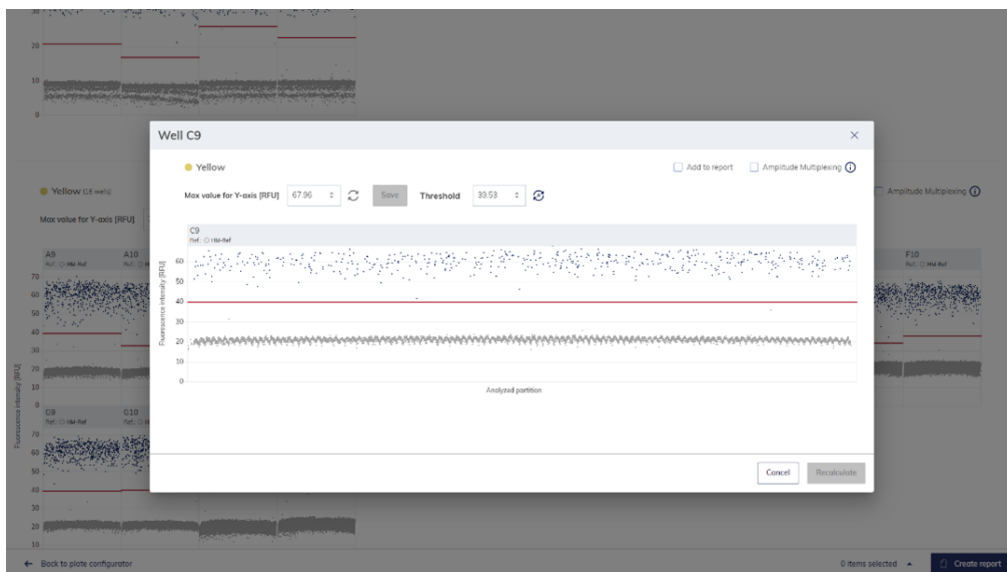

The user can change the range of the y axis by adjusting the value in the field Max value for the y axis (RFU) and clicking **Save**. For resetting the y axis to the default range, press the **Back to default** button. The view of the diagram is adapted accordingly.



Changing the threshold individually per well

1. To change the threshold individually per well, click the appropriate header of the well in the 1D Scatterplot view. A window opens and the threshold can be changed by pointing over the chart, which triggers the appearance of a dotted line.
2. Once the dotted line is in the appropriate spot, click the chart. The line becomes solid, and the threshold value is updated and shown in the Threshold field.
3. To change the value again using this method, click the red line, and drag it to the appropriate spot. Alternatively, user can also directly edit the value in the Threshold field. Use the **Auto-threshold** (🔄) button to set the threshold to the value, which is calculated by the analysis algorithm.

Note: The Threshold field and the **Auto-threshold** (🔄) button become only visible by moving the pointer in the range of the well diagram.

4. Click **Recalculate** to trigger the re-analysis of data and to close the window. Click **Cancel** to close the window without any changes.



Note: To add a single well diagram to the report, click **Add to report**. For more information on reports, see “Reports”.

Changing the thresholds for all selected wells (Common threshold)

The 1D Scatterplot view provides an option to set a common threshold value for all associated wells, using the Common threshold input field. Click the **Recalculate** button to trigger the re-analysis of data.

Use the **Auto-threshold** button to reset the threshold to the values, which is calculated by the analysis algorithm for each well. Click the **Recalculate** button to trigger the re-analysis of data.

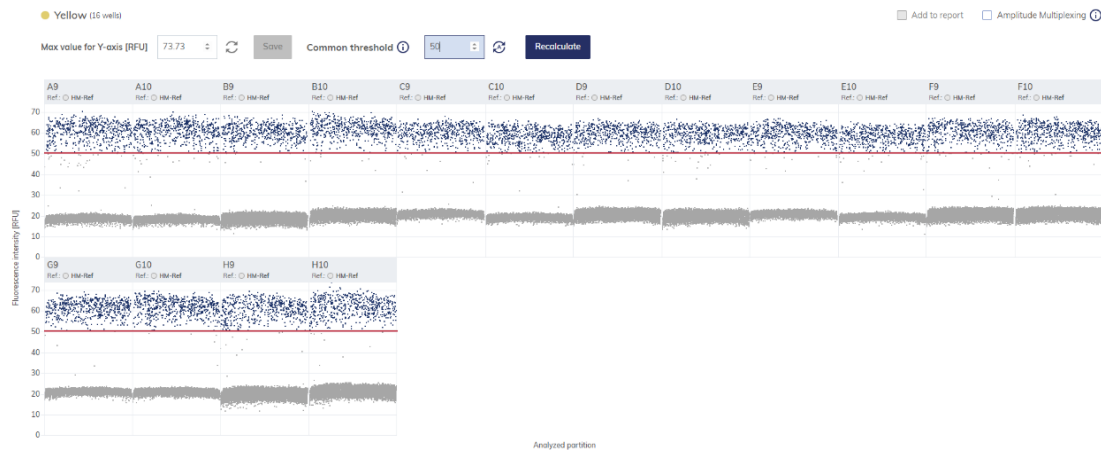

If user change thresholds and wants to leave the 1D Scatterplot view without triggering the **Recalculate** button, appropriate warning message windows opens.

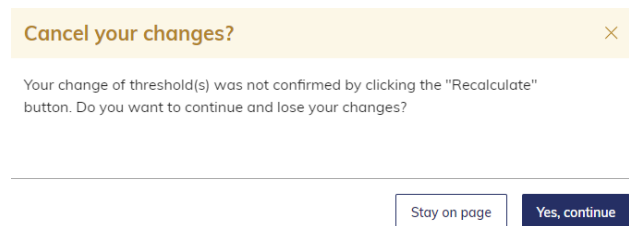

To add any of the 1D Scatterplot views to the report, click **Add to report** next to the relevant view. For more information on reports, see "Reports".

Setting amplitude multiplexing on 1D Scatterplot

1D Scatterplot allows to enable amplitude multiplexing split for a particular well, on a particular channel (Reaction mix with amplitude multiplexing split is not required).

Important: Amplitude multiplexing can be applied only for wells processed with the High Multiplexing Reference channel; otherwise when Standard Reference channel was used in particular Imaging step, this feature is not available.

Note: Amplitude multiplexing split cannot be applied for Reference channels: Standard Reference channel nor High Multiplexing Reference channel.

There are several methods to set amplitude multiplexing on different level:

1. Amplitude multiplexing drop-down menu allows to set AM split for all wells for selected channels at once. After checking the appropriate checkboxes (or choosing option **Select all**) and clicking the **Apply** button, changes are applied to all selected channels (auto-thresholds for Low, High, and Double positives are set) and there is no need to click the **Recalculate** button for each channel separately. Please note that this operation might take up to several minutes depending on selection.

Only channels selected in source selection are visible on the drop-down menu. When the checkbox for particular channel is ticked here, the checkbox in the particular channel section (described below) is ticked as well and vice versa – there is bi-directional interaction between them.

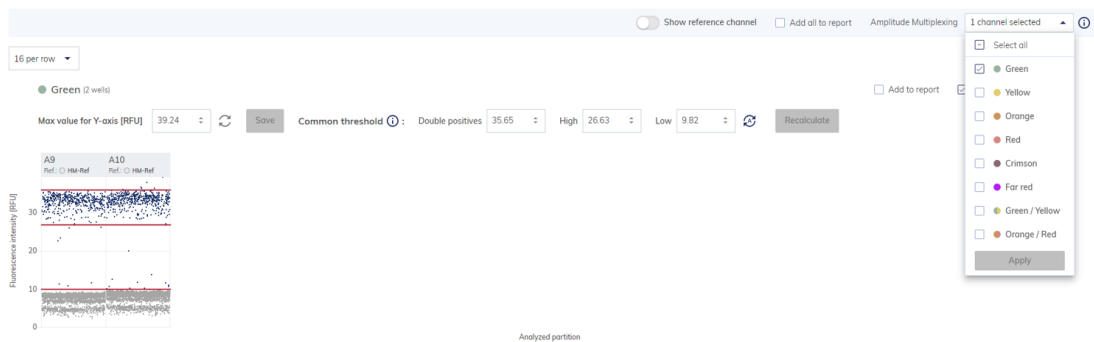

Example of 1D Scatterplot for channel Green with AM split applied via drop-down menu.

Note: When Std-Ref is used as a reference channel, amplitude multiplexing cannot be applied, then the **i** icon, next to drop-down menu, changes color from blue to yellow and, when user mouse hover it, appropriate information is displayed.

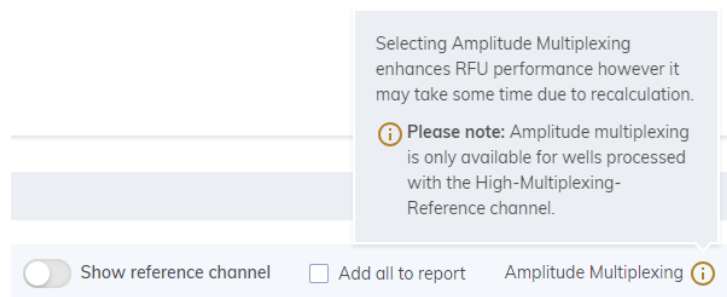

2. Amplitude multiplexing checkbox per channel – In each selected (in source selection) channel's section, there is the checkbox allowing to activate amplitude multiplexing mode.

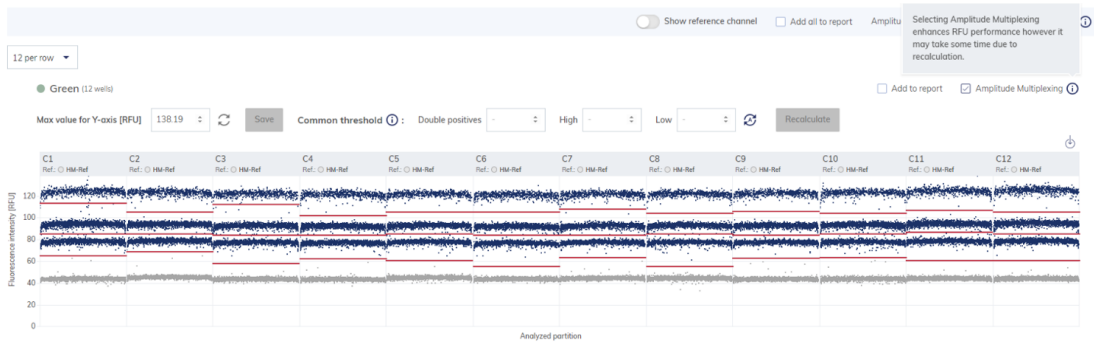

Example of 1D Scatterplot for channel Green with AM split applied via checkbox.

Each checkbox state is coupled with aforementioned drop-down menu. If AM cannot be enabled, the following information is presented:

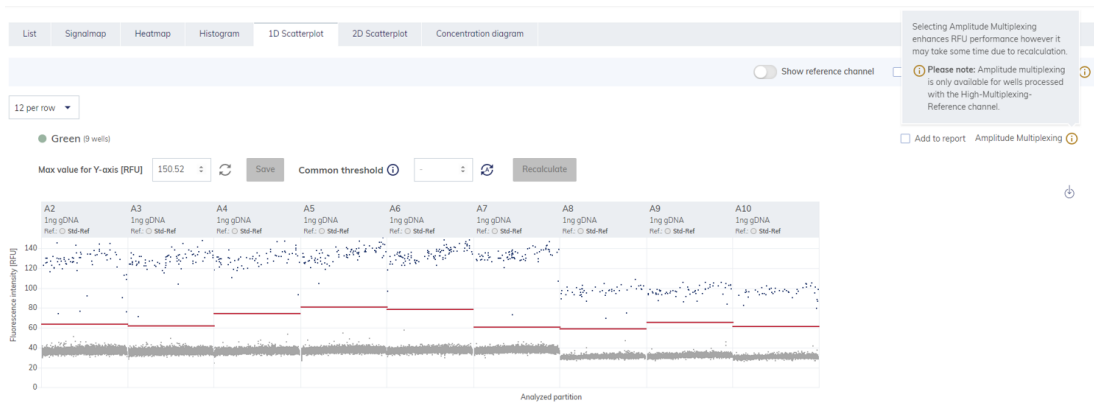

3. Enlarged view of well – User can enlarge well and apply AM split for single well on this view.

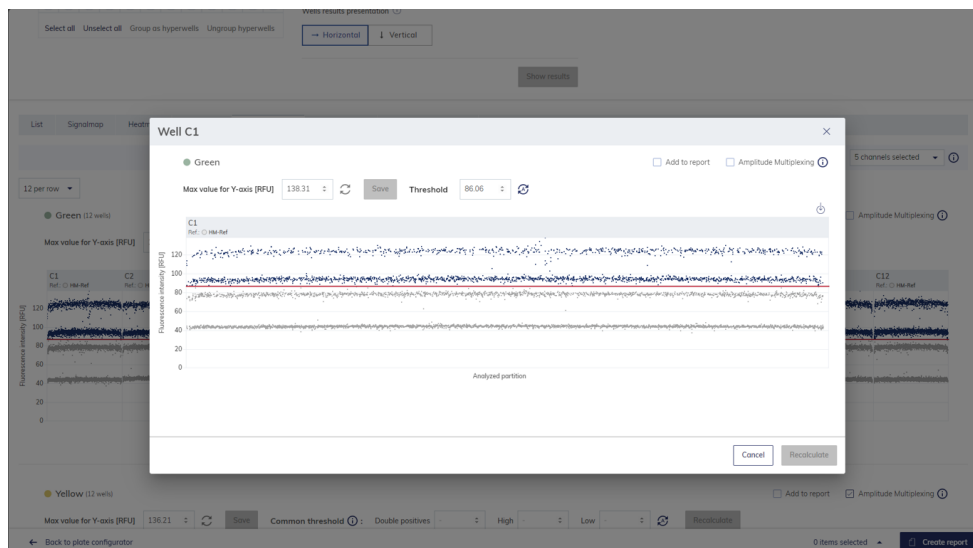

Also here, HM-Ref is required; otherwise, a warning is presented.

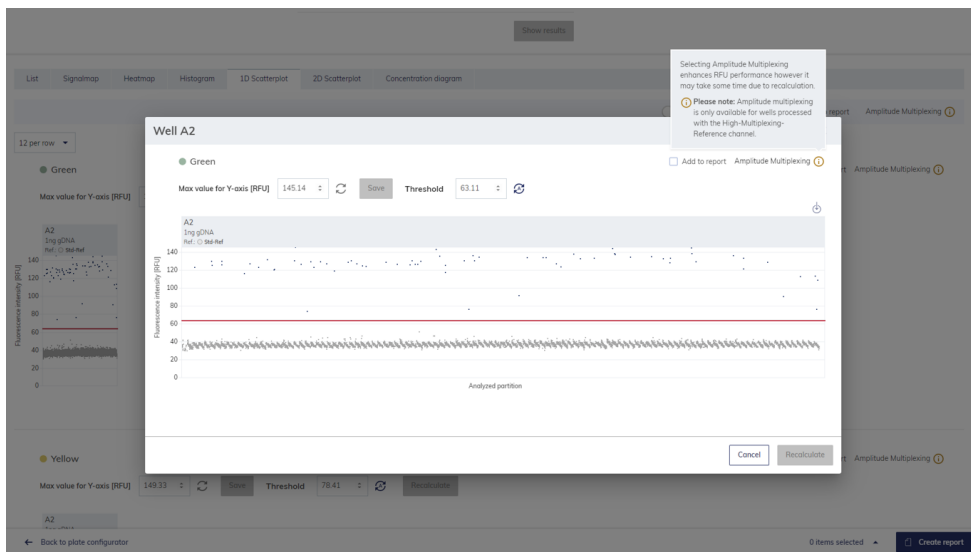

Please note that, after such operation, changed well becomes outlier comparing to the other selected wells on a particular channel. In such state, user cannot set common threshold nor apply AM for the rest of wells using checkbox nor via drop-down menu – the first well needs to be reverted to single threshold mode, following the opposite procedure as described above.

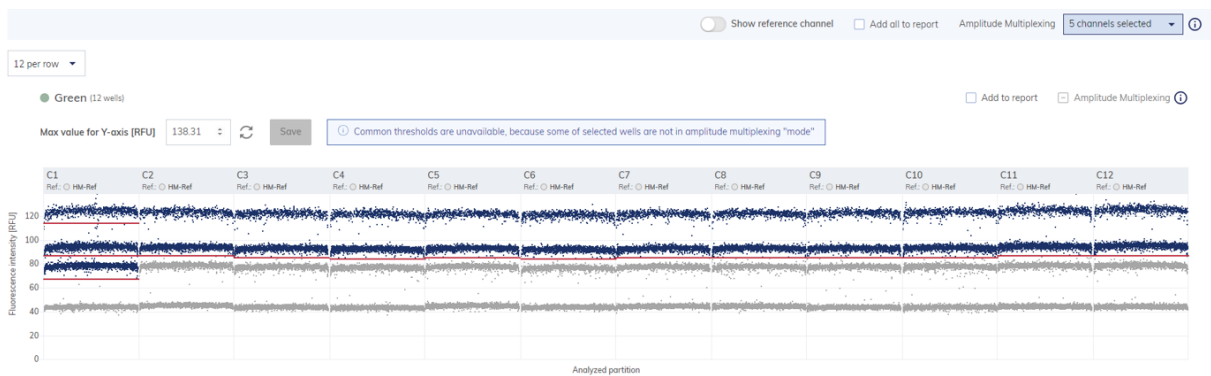

When amplitude multiplexing is applied, user can adjust threshold(s) in the same manner as for single thresholds but the difference is there are three text inputs and red lines instead of one. Moreover, recalibration is required at the end.

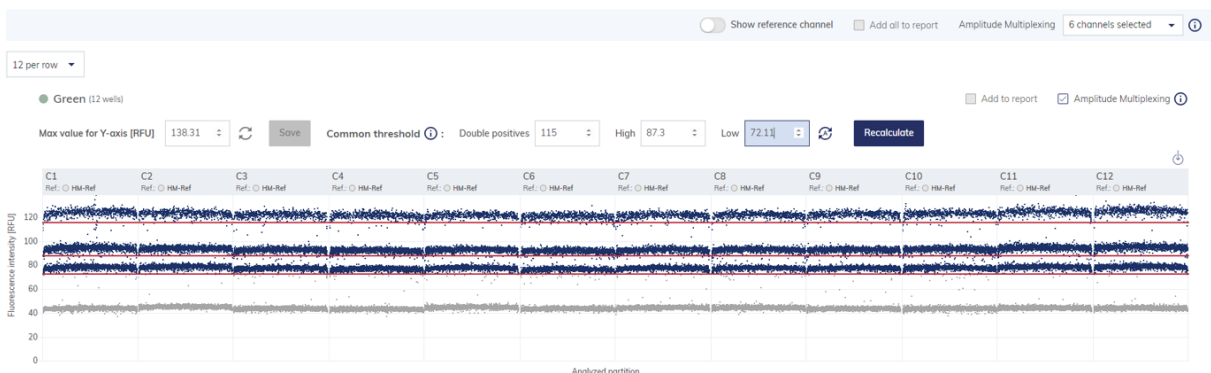

Reference channel on 1D Scatterplot

The Software Suite also provides a 1D Scatterplot view for the reference channel, which is hidden by default. To view the 1D Scatterplot for the reference channel in addition, click **Show reference channel**. The title of this 1D Scatterplot view indicates that the 1D Scatterplot is related to the particular reference channel – standard reference channel (Std-Ref) or high-multiplexing reference channel (HM-Ref). In case of mixed scenarios when two types of reference channels are detected by Algorithm, two separate plots are presented.

The graph for the reference channel provides the possibility to set a lower as well as an upper threshold to exclude partitions with too high/too low RFU. Setting the thresholds (individually per well or common lower and upper threshold for all selected wells) is analog to 1D Scatterplots for target channels. To apply the new threshold values for the analysis, click **Recalculate**. The 1D Scatterplot for the reference channel uses the same functions as the 1D Scatterplot views for non-reference channels.



2D Scatterplot tab for absolute quantification

The **2D Scatterplot** tab shows a 2D Scatterplot view that displays the fluorescence intensity from two selected channels or targets, allowing for a comparison and evaluation of the fluorescence from two sources.

To create a 2D Scatterplot, assign targets or channels to the x axis and y axis using the drop-down menus. When two of the selected sources for analysis are assigned, the 2D Scatterplot view is displayed.

Note: If reaction mix contains only two channels/targets, they will be automatically assigned to axis for 2D Scatterplot result view.

The axes represent the value of fluorescence intensity. The ranges of the axis are aligned with the maximal values presented from 0 to maximal fluorescence intensity of selected channel measured. The user can change the range of the x axis and the y axis by modifying the max value of the fluorescence intensity on the x axis and the y axis. For this, the user adjusts the value in the field to Max value for the x axis (RFU) or Max value for the y axis (RFU) and press **Save**. Resetting the x axis and the y axis to the default range is provided by using the **Back to Default** buttons.

The application also presents number of double positives (++) and double negatives (--), and number of partitions that are positives on one channel and negative on the other (+-, -+). To view updated results after changing threshold, click the **Recalculate** button.

To view an additional toolbar that enables you to perform actions related to the 2D Scatterplot view, such as downloading the plot, hold the pointer over the diagram. For more details about the toolbar, refer to “Diagram options”.

The Common threshold field for each axis shows the common threshold value for each selected well of the fluorescence intensity, which is used to distinguish between positive and negative partitions. If only one source well is selected, the values of the thresholds for the targets or channels on each axis are shown in the Common threshold fields and on the graph in the form of red lines. If multiple source wells are defined and their automatically calculated threshold values are different, a common threshold value is initially not shown.

Setting the common thresholds for all selected wells and each axis (channel)

The 2D Scatterplot view provides an option to set a common threshold value for the x axis and y axis for all associated wells. There are two ways to change the threshold. The first one involves pointing to the chart, which triggers the appearance of two perpendicular dotted lines. Once the dotted lines are in the appropriate spot, click the chart. The lines become solid, and the threshold value is updated, and shown in the Threshold field. To change the value again using this method, click one of the red lines and drag it to the appropriate spot. If needed, repeat this step with the second line. In addition to moving the lines, directly edit the value in the Common threshold field of the associated axis. Click the **Recalculate** button to trigger the re-analysis of data.

Note: Amplitude multiplexing is not available for 2D Scatterplot analysis, and channels that have this mode applied (via 1D Scatterplot) cannot be selected.

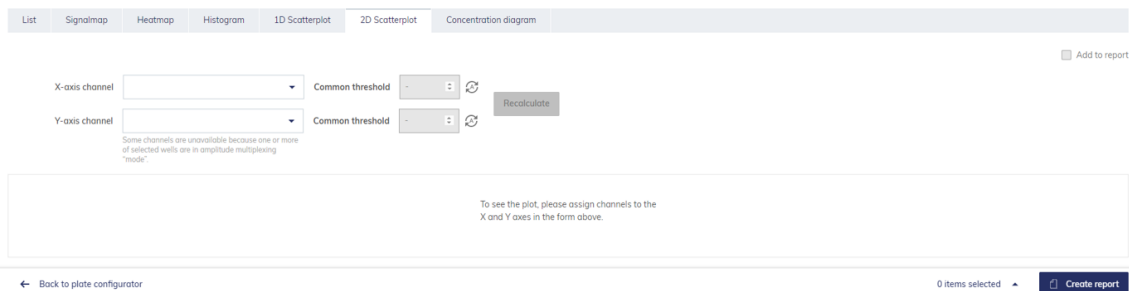

For each partition point the assignment to its group (++, +-, -+, or --) is derived from the threshold values. The partition number of each group is displayed on the top right, next to the diagram. The color of the point that represents the partition fluorescence measurement is assigned according to the group. A legend is shown on the left side below the 2D Scatterplot view:

1. On the 2D Scatterplot, only valid partitions are shown.
2. **Dark blue:** Partition is assigned for x axis and y axis channel as positive (++)
3. **Orange:** Partition is assigned to x axis channel as negative and for y axis channel as positive (-+).
4. **Light blue:** Partition is assigned to x axis channel as positive and for y axis channel as negative (+-).
5. **Gray:** Partition is assigned for x axis and y axis channel as negative (--).
6. The number of invalid partitions is shown in the legend at the right-hand side.

Invalid partitions on X mean the number of invalid partitions assigned to the x axis.

Invalid partitions on Y mean the number of invalid partitions assigned to the y axis.



2D Scatterplot view with two common thresholds.

Assigning partitions to a group using free hand (Polygon mode)

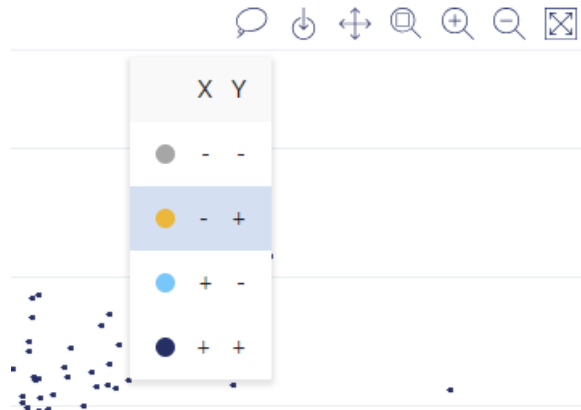

The user can select Polygon partitions measurement dots with a free-hand mode, so that he can use a more precise way to assign partitions to the group they should belong to. The polygon selection is available in menu above the diagram on hover.

1. When the **Polygon** icon () is clicked, the group (++, +-, --+, or ---) to which partitions should be assigned using the free-hand mode can be selected.

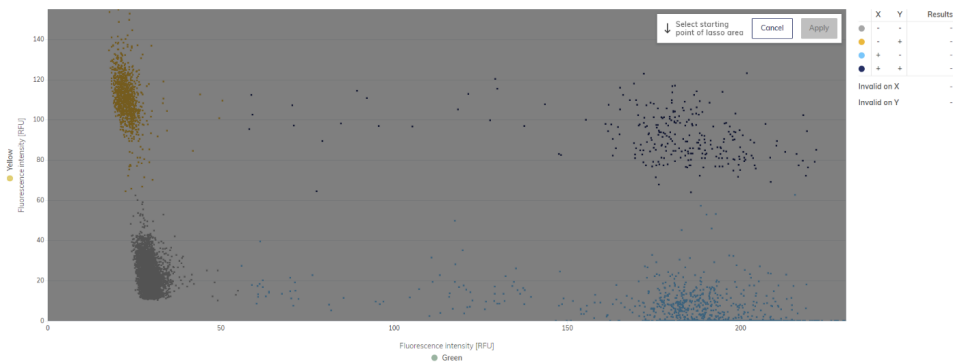

2. After selecting the group, plot area become dimmed, and legend is cleared, user can start drawing or exit polygon mode (click **Cancel** button).



3. User need to create polygon by placing its vertex on by one, until polygon become the closed area. After placing each vertex, there is possibility to undo last move (remove last vertex) using  icon or totally clear the polygon using  icon. Note that during drawing polygon lines cannot cross – in such case, dashed line become red and next vertex cannot be placed.

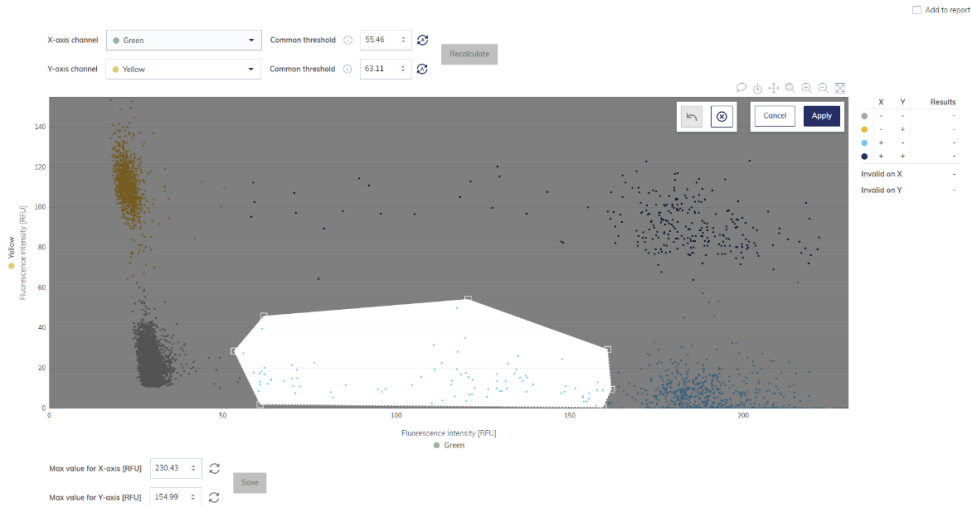

4. When polygon is drawn and closed, user can pan (move) the polygon over plot area if needed.
5. Finally, user should click the **Apply** icon (this icon become active) to apply the changes. Partitions on plot will change the color, but polygon is not reflected in results until user presses **Recalculate**. Until that moment, legend is cleared and appropriate communication is presented.

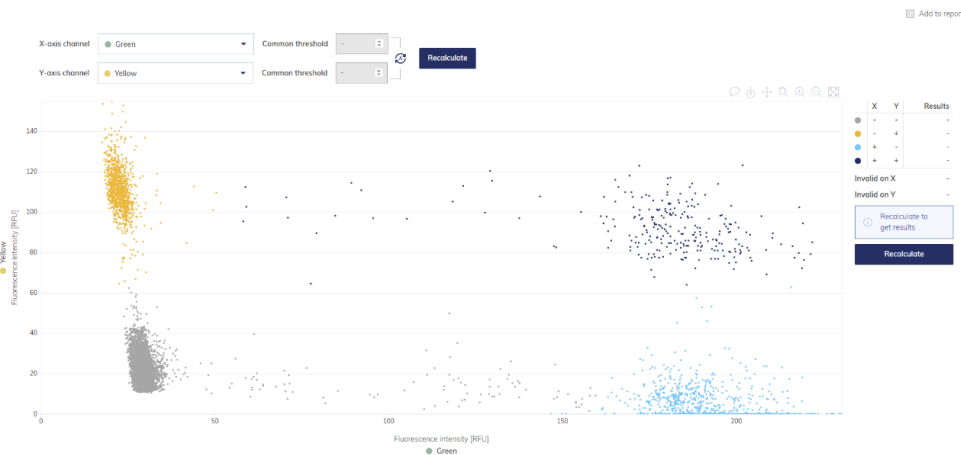

6. After selecting points by polygon, the user can set thresholds only by clicking the **Auto-threshold** icon. Clicking this icon reactivates the threshold behavior. The user can use either the polygon mode or threshold setting. A combination of both is not possible. When thresholds are changed and not confirmed by clicking the **Recalculate** button, and if some partitions are selected through polygon mode and recalculated, the threshold values are ignored. User can discard changes using **Auto-threshold** button, which become common for both axes.

Note: The points selection in polygon mode is additive. User can add points to the selected group or create new groups until **Recalculate** button is pressed.

7. After pressing the **Recalculate** button, user gets the results – legend is filled with results. Polygon selection in 2D Scatterplot also affects histogram and 1D Scatterplots views. For details, refer to “Histogram tab for absolute quantification” and “1D Scatterplot tab for absolute quantification” sections.

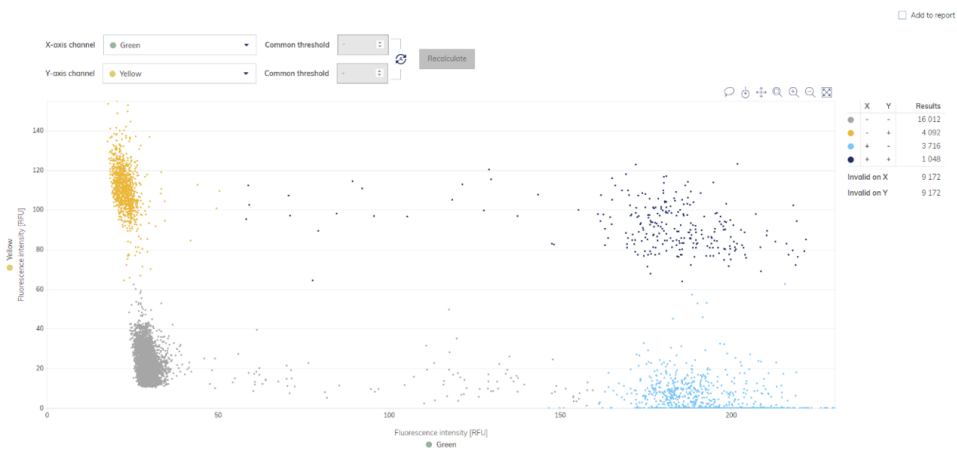

To adjust axis to ease drawing user can change values of x and y axis using panel below the plot:

Max value for X-axis [RFU]

Max value for Y-axis [RFU]

To add the 2D scatterplot to the report, click **Add to report**. For more information on reports, see section “Reports”.

2D Scatterplot Custom analysis

The user can click **Custom analysis** below main 2D Scatterplot graph to expand two modes of 2D Scatterplot analysis: All selected wells and Sample mode.

1. Mode All selected wells

In mode All selected wells, each well selected on source selection is represented by separate mini 2D Scatterplot. Merging of above mini plots creates main 2D Scatterplot described in above paragraphs – it means that any change (e.g., threshold change) introduced on main 2D Scatterplot will directly influence the mini plots and in opposite way – changes made on particular mini plot will impact main plot.



Each mini 2D Scatterplot title bar contains following information:

- Well ID
- Hyperwell ID (if wells has been grouped into hyperwell on source selection)
- Sample name (if assigned to well)
- Detected reference channel (Std-Ref or HM-Ref)
- Temperature in well (if gradient was applied)

Each mini 2D Scatterplot can be enlarged by clicking the gray title bar with above information. Then new window Well details appears. In new window, on enlarged mini plot, user can perform similar actions like on main 2D Scatterplot and additionally use navigation buttons to switch between mini plots particular wells presented on overview.



Important: In case of threshold changes – line threshold and lasso(polygon) or using auto-threshold function, changes on plot are automatically recalculated (and there is no need to additionally click any button).

In case user created some hyperwells in source selection, on analysis per target, mini 2D Scatterplots representing wells being part of hyperwells have colorful bar and hyperwell ID indicating particular hyperwells.

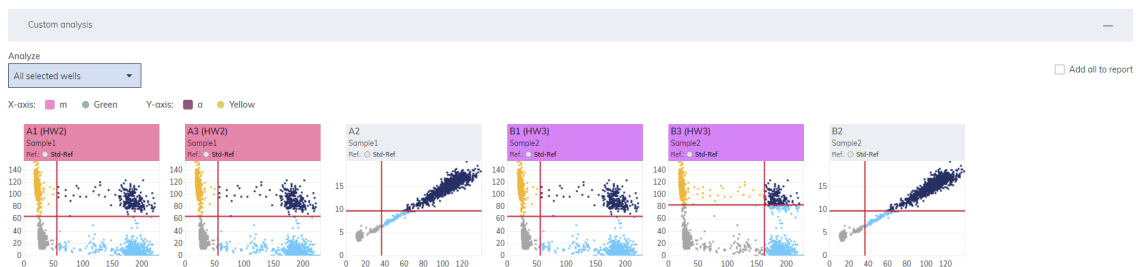

In this scenario, when user clicks the colorful bar to enlarge particular mini 2D Scatterplot instead of Well details, other modal window – **Hyperwell details** – is presented. This modal represents merged 2D Scatterplot of all wells being part of selected hyperwell; user operates on group of wells instead of single one. Rest of behaviors of this window remains the same as for Well details.

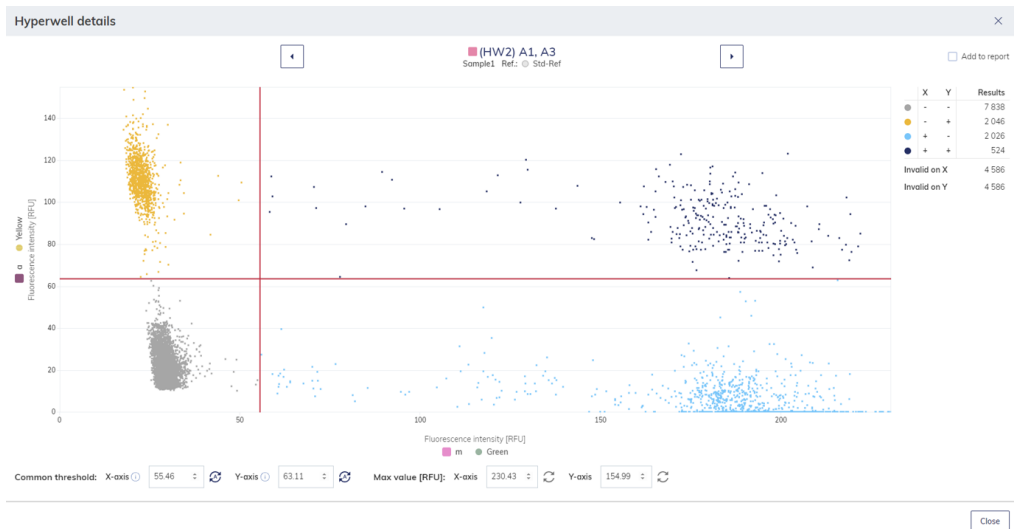

2. Mode Samples

In mode Samples, user additionally selects samples that will be presented:



Note: If no samples are assigned to selected wells, mode Samples will be inactive.

After selecting samples, the overview of Custom analysis is divided into horizontal sections – each section represents replicates of particular Samples of one reaction mix. Each section consists of grouped: 2D Scatterplot (merged one of particular mini 2D Scatterplots) and those mini plots itself.

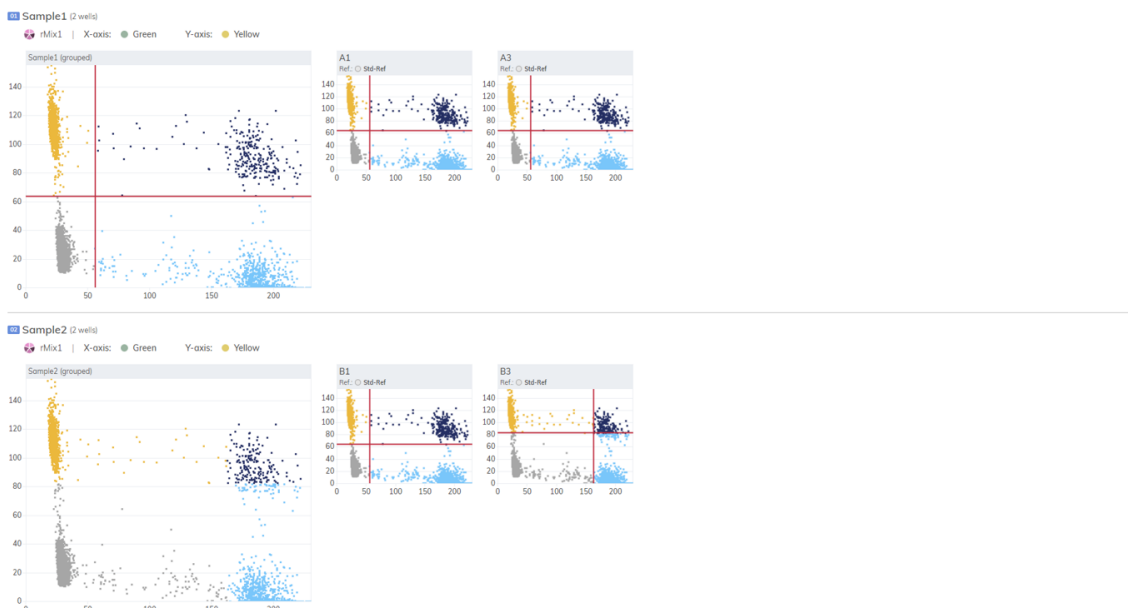

Any change, for example, threshold change introduced on mini 2D Scatterplot of particular sample, will affect grouped 2D Scatterplot of that sample and main 2D Scatterplot.

Each individual mini plot can be enlarged by clicking gray bar, but here Replicate details window appears and user navigates between particular replicates (mini 2D Scatterplots from particular sections).



Grouped plot can be also enlarged by clicking the title bar and then Sample details modal window appears. Here, the user navigates between grouped plots (if several Samples have been selected in Custom analysis).



Important: In case of threshold changes done on one Replicates window or Sample, data are automatically recalculated immediately

In case user created some hyperwells in source selection, on analysis per target, mini 2D Scatterplots representing replicates being part of hyperwells have colorful bar and hyperwell ID indicating particular hyperwells.



Clicking the bar enlarges the particular mini 2D Scatterplot. Hyperwell details is presented. This modal represents merged 2D Scatterplot of all wells being part of selected hyperwell – user operates on group of wells instead of single one.

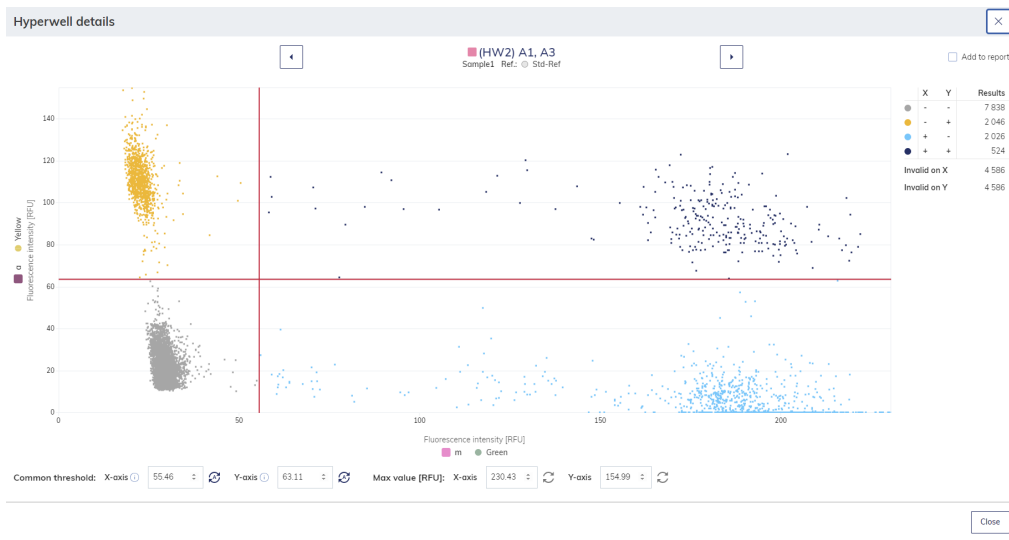

Concentration diagram tab for absolute quantification

The **Concentration Diagram** tab shows the diagrams that display the distribution of concentration values and confidence intervals. One diagram is created for each selected target or channel. A concentration diagram has two axes. The x axis shows the analyzed wells, and the y axis represents the concentration values for the selected targets or channels of each well. The values on the y axis have two available scales – linear and logarithmic.

When amplitude multiplexing is applied, separate concentration diagrams are generated for “Low” and “High” part of the channel.

To view an additional toolbar that enables user to perform actions related to the diagram, such as downloading the plot, hold the pointer over the diagram. For more details about the toolbar, refer to section “Diagram options”.

The y axis scale can be modified using the buttons located below each graph. The buttons are visible when you hold the pointer over a graph. To view the values on a linear scale, click **lin**. To view the values on a logarithmic scale, click **log10**.

Each diagram presents two values for each well – the concentration value, displayed as a bar, and the confidence interval, displayed as an error bar. To view the exact values, point to one of the bars. After a concentration diagram loads, the first 32 wells are shown in the diagram. To view other wells, use the slider located below the diagram.

To view the mean values for replicates on the diagram, click **Show mean values for replicates**. In this case, one bar is shown for a replicate group showing the mean concentration value and the mean CI value of the replicate group. To view exact values and a list of wells belonging to the replicate group point to the associated bar.

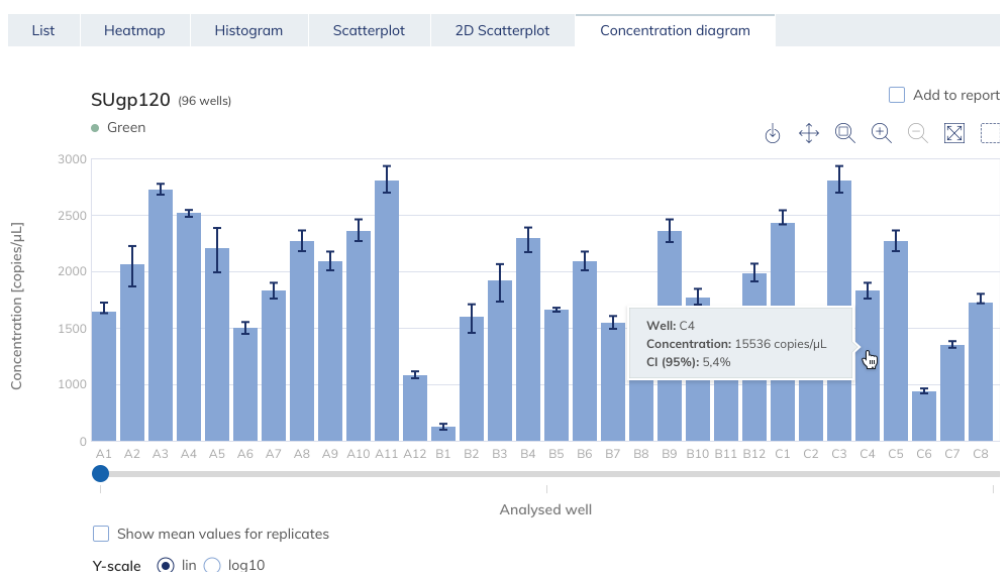

To add any of the concentration diagrams to the report, click **Add to report** next to the relevant diagram. For more information on reports, see section “Reports”.

7.6.16. Mutation detection

The Plate Analysis environment of the Software Suite includes the **Mutation Detection** tab. Mutation Detection analysis is based on the concentrations (see “Absolute quantification”). To use mutation detection, the definition of targets in the reaction mixes and samples is mandatory. For more information, see section “Setting up an experiment”.

The **Mutation Detection** tab is used to show the results of analyzing plate contents to detect mutations in the samples. The analysis results are put into list views, heatmaps, point diagrams, and concentration diagrams.

Note: Saving of mutation detection tests is not available.

Note: Amplitude multiplexing is not supported for Mutation Detection analysis – targets n amplitude multiplexing mode (“Low” and “High”) are disabled during selection.

Setting up a mutation detection analysis

1. Click the relevant wells in the Select wells pane. For more information, see “Selecting wells for analysis”.

Absolute Quantification **Mutation Detection** Genome Editing Copy Number Variation Gene Expression

Select source of mutation detection (0 wells)

	1	2	3	4	5	6	7	8	9	10	11	12
A	01	01	01	01	01	01	01	01	01	01	01	01
B	02	02	02	02	02	02	02	02	02	02	02	02
C	01	01	01	02	02	02	03	03	03	04	04	04
D	01	01	01	02	02	02	03	03	03	04	04	04
E	C	C	C	C	C	C	C	C	C	C	C	C
F	C	C	C	C	C	C	C	C	C	C	C	C
G	NTC	NTC	NTC	NTC	NTC	NTC	NTC	NTC	NTC	NTC	NTC	NTC
H	C	C	C	C	C	C	C	C	C	C	C	C

Select all Unselect all Group as hyperwells Ungroup hyperwells

Select imaging step

1 2

Wild type target*

Selection should cover min. 2 targets sharing the same sample

Mutant target*

Selection should cover min. 2 targets sharing the same sample

Show results







2. Select the applicable wild-type target from the **Wild type target** list.
3. Select the applicable mutant target from the **Mutant target** list.
4. To view the results of the analysis, click **Show results**.
5. The results are divided into several tabs. To view the contents of the tab, click the tab title.

List tab for mutation detection

The **List** tab contains a table with an overview of the analyzed wells. The following columns are available in the table.

- Well ID** – This column represents the well position in the plate layout. If gradient cycling was used the temperature is displayed in addition.
- Sample/NTC/Control** – This column shows the sample, NTC, or control name with its corresponding icon that identifies the sample or indicates whether the entry is an NTC or control.
- Reaction mix** – This column contains the icon and the name of the Reaction mix.
- Target** – This column shows all target names with its corresponding target type. Targets that were selected as wild type or mutant are marked accordingly.
- Conc. [copies/μL]** – This column shows the concentration assigned to each target.
- CI (95%)** – This column shows the value of the confidence interval at a 95% confidence level.
 - When checkbox “Show mean values for replicates” is checked, following two columns are displayed additionally:
 - Mean conc. [copies/μL] – This column shows the mean concentration assigned to each target or channel per well for replicates.
 - CI (95%) – This column shows the value of the confidence interval at a 95% confidence level for the mean concentration.

Note: Columns related to Concentration and Mean concentration can provide additionally sub-columns, depending if dilution factor and/or conversion factor (described in sections “Dilution calculation option” and “Conversion factor”, accordingly) have been selected.
- Mutation fraction** – This column shows the Mutant fraction value in percentage.
- CI (95%)** – This column shows the value of the confidence interval for mutant fraction at a 95% confidence level.

Sample/NTC/Control	Reaction Mix	Name	Target IC	Type	Conc. copy/μL	CI (95%)	Mutant fraction	CI (95%)
A2	 rMix1 Ref. channel:  Std-Ref	T2	-	MT	21.89	25.1%	46.5512%	18.6%
		T1	-	WT	25.14	23.4%	-	-
A3	 rMix1 Ref. channel:  Std-Ref	T2	-	MT	22.22	24.9%	44.9064%	18.7%
		T1	-	WT	27.25	22.5%	-	-
A4	 rMix1 Ref. channel:  Std-Ref	T2	-	MT	25.95	23.1%	52.9534%	16.1%
		T1	-	WT	23.05	24.5%	-	-

Replicates are treated different for multiplex and simplex test setup:

- Multiplex test (configured wild-type and mutant targets are part of the same reaction mix):
 - Replicates are analyzed as separate wells, but in addition the mean concentration and mean mutant fraction values together with the corresponding mean CI are provided on demand.
 - On the upper right side of the table above, there is checkbox that allows the user to show mean values for replicates in addition. By default, the button is unchecked, and results are displayed without mean values. When the button is

checked, the list view still shows independent rows for each selected well, but replicates are grouped together. Replicates from the same group are next to each other in the list view. The list view is extended by four columns indicating following mean values:

- Mean conc. [copies/ μ L] – mean concentration value
- CI (95%) – CI of mean concentration as percentage
- Mean mutation fraction as percentage
- CI (95%) – CI of mean mutation fraction as percentage

2. Simplex test (configured wild-type and mutant targets are part of different reaction mixes):

For tests having the configured targets in different wells/reaction mixes, the mean result is calculated and shown for replicates in the selection. The list view is extended by four columns indicating following mean values:

- Mean conc. [copies/ μ L] – mean concentration value
- CI (95%) – CI of mean concentration as percentage
- Mean mutation fraction as percentage
- CI (95%) – CI of mean mutation fraction as percentage
- The replicate results are shown in one row per replicate group. Individual replicate results are not available. The checkbox that allows the user to show mean values for replicates is checked and disabled.

To export the list view information as .csv file, click **Export to CSV** and select current results.

Heatmap tab for mutation detection

The **Heatmap** tab contains a heatmap that shows the mutant fraction as percentage in each of the wells. If a well is not selected as a source for the analysis, the value is not displayed on the heatmap and its background color is gray.

To view detailed information about a well, point the cursor over the well. A tooltip with detailed information opens.

To view an additional toolbar that enables actions related to the diagram, such as downloading the plot, hold the pointer over the diagram. For more details about the toolbar, refer to section “Diagram options”.

There are several additional options that user can select:

1. **Use sample dilution** – enables calculations related to dilution factor. Results in undiluted sample is additionally presented on well tiles. Described in section “Dilution calculation option”.
2. **Use conversion factor** – conversion of results into unit given by user. Results in converted unit replace standard ones on well tiles. See section “Conversion factor”.
3. **Show mean values for replicates** – showing the mean concentration values for replicates. For simplex tests, the mean values view is always shown for replicates and cannot be disabled.

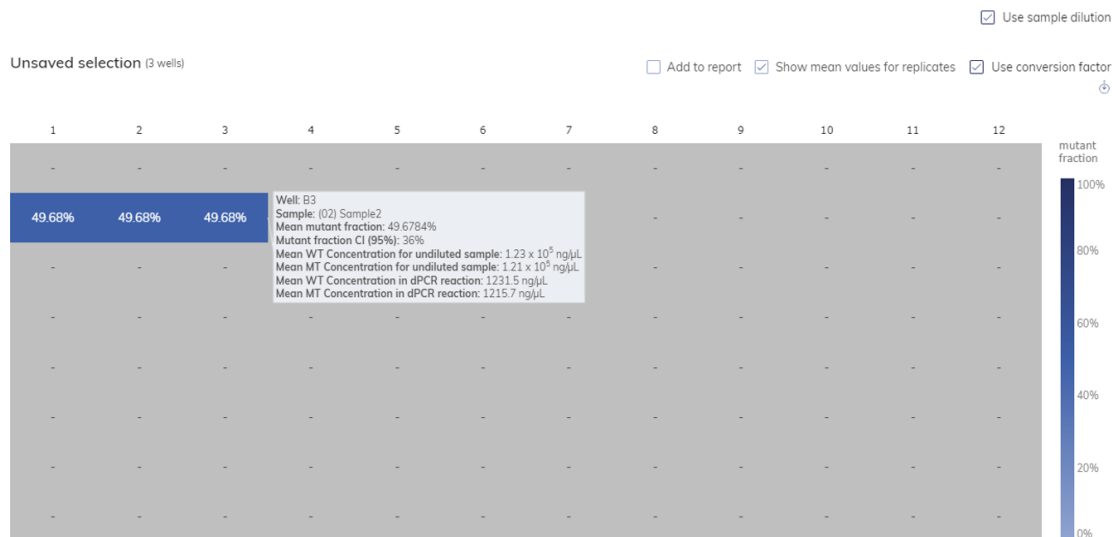

To add the heatmap diagram to the report, click **Add to report**. For more information on reports, see section “Reports”.

Point diagram tab for mutation detection

The **Point diagram** tab shows a diagram that displays the percentage of mutant fractions in each analyzed well. A point diagram has two axes. The x axis shows the analyzed wells and samples, and the y axis represents the mutant fraction, shown as a percentage.

To view an additional toolbar that enables actions related to the diagram, such as downloading the plot, hold the pointer over the diagram. For more details about the toolbar, refer to section “Diagram options”.

The y axis scale can be modified from linear to logarithmic scale using the buttons located on the left below the diagram. The buttons are visible when the pointer is held over a graph. To view the values on a linear scale, click **lin**. To view the values on a logarithmic scale, click **log10**.

Each combination of wild-type target and mutant target in one sample throughout the selected wells is represented in the diagram with one point showing the concentration value together with the confidence interval. To view detailed information, hold the mouse pointer over its corresponding point. A tooltip with detailed information opens.

To view the mean values for replicates for multiplex test, click **Show mean values for replicates**. If the user clicks into the checkbox to select the mean representation for replicates, the points of individual replicates disappear and only one point is shown at the sample label that represents the mean mutant fraction value of the replicates. When there are no replicates within selected wells for mutant target the points do not change. The corresponding well IDs of the replicates are shown on the x axis. This is also applied in same way by default to the view where targets are in different reaction mixes. In this case, individual replicate results are not available. Mean values are calculated and shown over all replicates that are included in the well selection only. If there are further replicates of the same sample which are not included in well selection, they are not considered in the calculated mean value and show their individual results values.

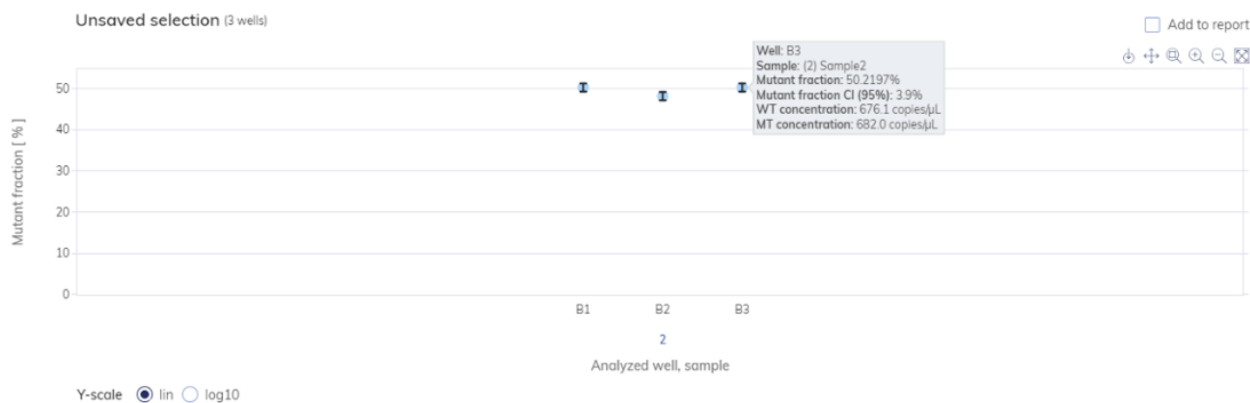

To add the point diagram to the report, click **Add to report**. For more information about reports, see section “Reports”.

Concentration diagram for mutation detection

The **Concentration diagram** tab shows a diagram that displays the distribution of concentration values in the wells together with their confidence intervals. A concentration diagram has two axes. The x axis shows the analyzed wells and samples, and the y axis represents the concentration values. The y axis scale can be modified using the buttons located below graph to view the values on a linear scale, click **lin**. To view the values on a logarithmic scale, click **log10**.

To view an additional toolbar that enables actions related to the diagram, such as downloading the plot, hold the pointer over the diagram. For more details about the toolbar, refer to section “Diagram options”.

Each combination of wild-type target and mutant target in one sample throughout the selected wells is represented in the diagram with one bar showing the concentration value together with the confidence interval. To view detailed information, hold the mouse pointer over its corresponding bar. A tooltip with detailed information opens.

To view the mean values for replicates on the concentration diagram, click **Show mean values for replicates**. If the user clicks into the checkbox to select the mean representation for replicates, the bars of individual replicates disappear and only one bar is shown at the sample label that represents the mean mutant fraction value of the replicates. When there are no replicates within selected wells for mutant target the bars do not change. The corresponding well IDs of the replicates are shown on the x axis. This is also applied in same way by default to the view where targets are in different reaction mixes. In this case individual replicate results are not available. Mean values are calculated and shown over all replicates that are included in the well selection only. If there are further replicates of the same sample that are not included in well selection, they are not considered in the calculated mean value and show their individual results values.

There are two additional options that user can select. First option is Use sample dilution, which as described in section “Dilution calculation option”, enables calculations related to dilution factor. Results in undiluted sample is additionally presented on well tiles, y axis scale is adjusted to results. Second option is Use conversion factor, which as described in section “Conversion factor”, enables conversion of results into unit given by user. Results in converted unit replace standard ones on well tiles, y axis scale is adjusted to results.

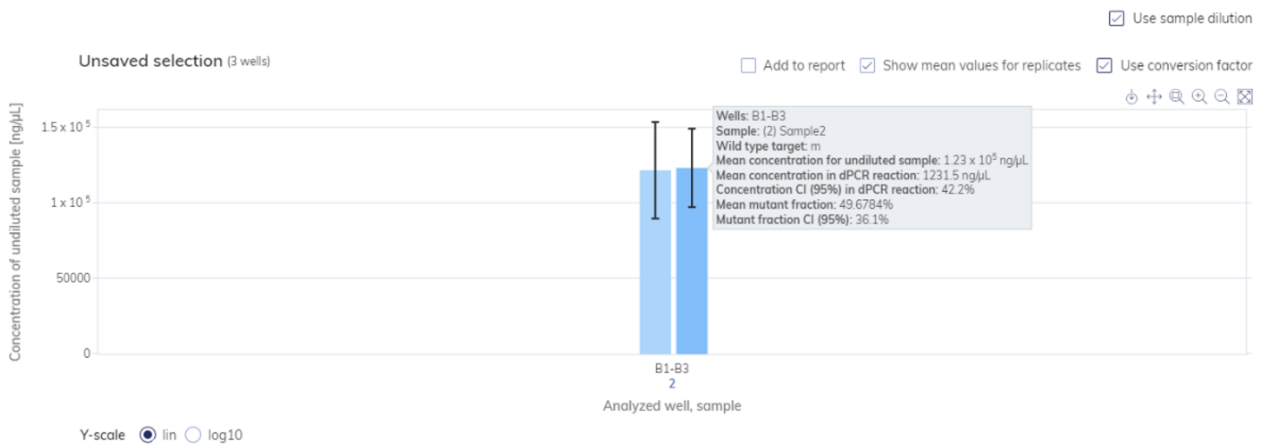

To add the concentration diagram to the report, click **Add to report**. For more information about reports, see section “Reports”.

7.6.17. Genome editing

The **Genome editing** tab contains views that provide insight into the number of edited genomes in analyzed wells. The analysis results are put into list views, heatmaps, point diagrams, and concentration diagrams.

Note: Saving genome editing tests is not yet provided.

Setting up a genome editing analysis

Note: Amplitude multiplexing is not supported for Genome editing analysis – targets in amplitude multiplexing mode (“Low” and “High”) are disabled during selection.

1. Click the applicable wells in the plate layout. For more information, see “Selecting wells for analysis”.

2. Select the applicable wild-type target from the **Wild type target** list.
3. Select the applicable edited target from the **Edited target** list.
4. To view the results of the analysis, click **Show results**.
5. The results are divided into several tabs. To view the contents of the tab, click the tab title.

List tab for genome editing

The **List** tab contains a table with an overview of the analyzed wells. The following columns are available in the table:

- Well ID** – Like A1, B2, when gradient was selected there is also temperature in the well (temperature range instead of single one, if hyperwells were selected).
 - Sample/NTC/Control** – This column shows the sample, NTC, or control name with its corresponding icon that identifies the sample or indicates whether the entry is an NTC or control.
 - Reaction mix** – This column contains the icon and the name of the reaction mix.
 - Target** – This column shows all target names with its corresponding target type. Targets that were selected as wild type or mutant are marked accordingly.
 - Conc. [copies/μL]** – This column shows the concentration assigned to each target.
 - CI (95%)** – This column shows the value of the confidence interval at a 95% confidence level.
 - When checkbox “Show mean values for replicates” is checked additionally two columns are displayed:
 - Mean conc. [copies/μL]** – This column shows the mean concentration assigned to each target or channel per well for replicates.
 - CI (95%)** – This column shows the value of the confidence interval at a 95% confidence level for the mean concentration.
- Note:** Columns related to Concentration and Mean concentration can be additionally divided into several sub-columns depending if dilution factor and/or conversion factor (described in sections “Dilution calculation option” and “Conversion factor”, accordingly) have been selected.
- Edited fraction** – This column shows the Mutant fraction value in %.
 - CI (95%)** – This column shows the value of the confidence interval for mutant fraction at a 95% confidence level.

List										
Heatmap Point diagram Concentration diagram										
<input type="checkbox"/> Add to report <input type="checkbox"/> Show mean values for replicates Export to CSV...										
Sample/NTC/Control	Reaction Mix	Target			Conc. [copies/μL]	CI (95%)	Edited fraction	CI (95%)		
		Name	IC	Type						
A2 1ng gDNA	rMix1 Ref. channel Std-Ref	T2	-	ET	21.89	25.1%	46.5512%	19%		
		T1	-	WT	25.14	23.4%	-	-		
A3 1ng gDNA	rMix1 Ref. channel Std-Ref	T2	-	ET	22.22	24.9%	44.9064%	19%		
		T1	-	WT	27.25	22.5%	-	-		
A4 1ng gDNA	rMix1 Ref. channel Std-Ref	T2	-	ET	25.95	23.1%	52.9534%	16%		
		T1	-	WT	23.05	24.5%	-	-		

Replicates are treated different for multiplex and simplex test setup:

1. Multiplex test (configured wild-type and edited targets are part of the same reaction mix):
 - a. Replicates are analyzed as separate wells but in addition the mean concentration and mean edited fraction values together with the corresponding mean CI are provided on demand.
 - b. On the upper right side of the table, there is checkbox that allows the user to show mean values for replicates in addition. By default, the button is unchecked, and results are displayed without mean values. When the button is checked the list view still shows independent rows for each selected well, but replicates are grouped together. Replicates from the same group are next to each other in the list view. The list view is extended by four columns indicating following mean values:
 - Mean conc. [copies/ μ L] – mean concentration value
 - CI (95%) – CI of mean concentration as percentage
 - Mean edited fraction as percentage
 - CI (95%) – CI of mean edited fraction as percentage
2. Simplex test (configured wild-type and edited targets are part of different reaction mixes):
 - a. For tests having the configured targets in different wells/reaction mixes, the mean result is calculated and shown for replicates in the selection. The list view is extended by four columns indicating following mean values:
 - Mean conc. [copies/ μ L] – mean concentration value
 - CI (95%) – CI of mean concentration as percentage
 - Mean edited fraction as percentage
 - CI (95%) – CI of mean edited fraction as percentage

The replicate results are shown in one row per replicate group. Individual replicate results are not available. The checkbox that allows the user to show mean values for replicates is checked and disabled. To export the list view information as a .csv file, click **Export to CSV**.

Heatmap tab for genome editing

The **Heatmap** tab contains heatmaps that show the edited fraction as percentage in each of the wells. If a well is not selected as a source for the analysis, the value is not displayed on the heatmap and its background color is gray.

To view detailed information about a particular well, point the cursor over the well. A tooltip with detailed information opens.

To view an additional toolbar that enables actions related to the diagram, such as downloading the plot, hold the pointer over the diagram. For more details about the toolbar, refer to “Diagram options”.

1. **Use sample dilution** – as described in section “Dilution calculation option”, enables calculations related to dilution factor. Results in undiluted sample is additionally presented on well tiles.
2. **Use conversion factor** – as described in section “Conversion factor”, enables conversion of results into unit given by user. Results in converted unit replace standard ones on well tiles.
3. **Show mean values for replicates** – showing the mean concentration values for replicates. For simplex tests the mean values, view is always shown for replicates and cannot be disabled.

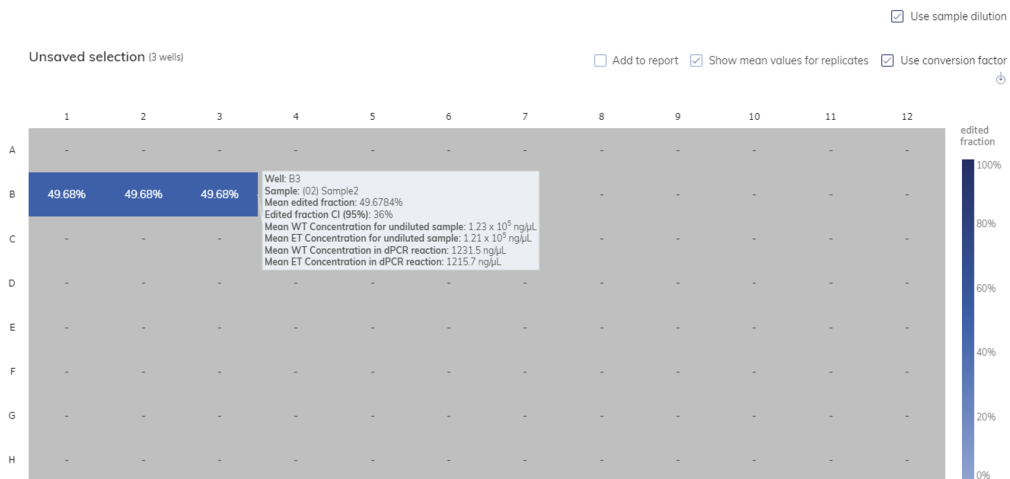

To add the heatmap to the report, click **Add to report**. For more information on reports, see section “Reports”.

Point diagram tab for genome editing

The **Point diagram** tab shows a diagram that displays the percentage of edited fractions in each analyzed well. A point diagram has two axes. The x axis shows the analyzed wells and samples, and the y axis represents the edited fraction, shown as a percentage.

To view an additional toolbar that enables actions related to the diagram, such as downloading the plot, hold the pointer over the diagram. For more details about the toolbar, refer to section “Diagram options”.

The y axis scale can be modified using the buttons located below each graph. The buttons are visible when the pointer is held over a graph. To view the values on a linear scale, click **lin**. To view the values on a logarithmic scale, click **log10**.

Each combination of wild-type target and edited target in one sample throughout the selected wells is represented in the diagram with one point showing the concentration value together with the confidence interval. To view detailed information, hold the mouse pointer over its corresponding point. A tooltip with detailed information opens.

To view the mean values for replicates, click **Show mean values for replicates**. If the user clicks into the checkbox to select the mean representation for replicates, the points of individual replicates disappear and only one point is shown at the sample label that represents the mean edited fraction value of the replicates. When there are no replicates within selected wells for edited target the points do not change. The corresponding well IDs of the replicates are shown on the x axis. This is also applied in same way by default to the view where targets are in different reaction mixes. In this case, individual replicate results are not available. Mean values are calculated and shown over all replicates that are included in the well selection only. If there are further replicates of the same sample that are not included in well selection, they are not considered in the calculated mean value and show their individual results values.

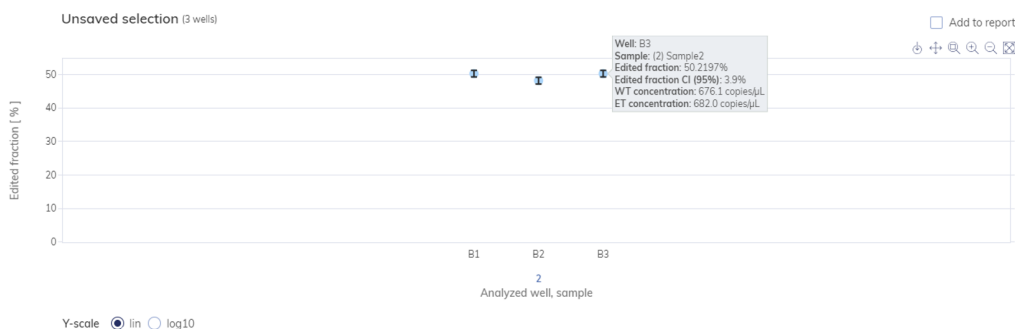

To add the point diagram to the report, click **Add to report**. For more information on reports, see section “Reports”.

Concentration diagram tab for genome editing

The **Concentration diagram** tab shows a diagram that displays the distribution of concentration values in the wells together with their confidence intervals. A concentration diagram has two axes. The x axis shows the analyzed wells and samples, and the y axis represents the concentration values. The y axis scale can be modified using the buttons located below each graph. The buttons are visible when you hold the pointer over a graph. To view the values on a linear scale, click **lin**. To view the values on a logarithmic scale, click **log10**.

To view an additional toolbar that enables actions related to the diagram, such as downloading the plot, hold the pointer over the diagram. For more details about the toolbar, refer to “Diagram options”.

Each combination of wild-type target and edited target in one sample throughout the selected wells is represented in the diagram with one bar showing the concentration value together with the confidence interval. To view detailed information, hold the mouse pointer over its corresponding bar. A tooltip with detailed information opens.

To view the mean values for replicates on the concentration diagram, click **Show mean values for replicates**. If the user clicks into the checkbox to select the mean representation for replicates, the bars of individual replicates disappear and only one bar is shown at the sample label that represents the mean edited fraction value of the replicates. When there are no replicates within selected wells for edited target, the bars do not change. The corresponding well IDs of the replicates are shown on the x axis. This is also applied in same way by default to the view where targets are in different reaction mixes. In this case, individual replicate results are not available. Mean values are calculated and shown over all replicates that are included in the well selection only. If there are further replicates of the same sample that are not included in the well selection, they are not considered in the calculated mean value and show their individual results values.

There are two additional options that user can select. First option is Use sample dilution – as described in section “Dilution calculation option”, enables calculations related to dilution factor. Results in undiluted sample is additionally presented on well tiles; y axis scale is adjusted to results. Second option is Use conversion factor – as described in section “Conversion factor”, enables conversion of results into unit given by user. Results in converted unit replace standard ones on well tiles; y axis scale is adjusted to results.

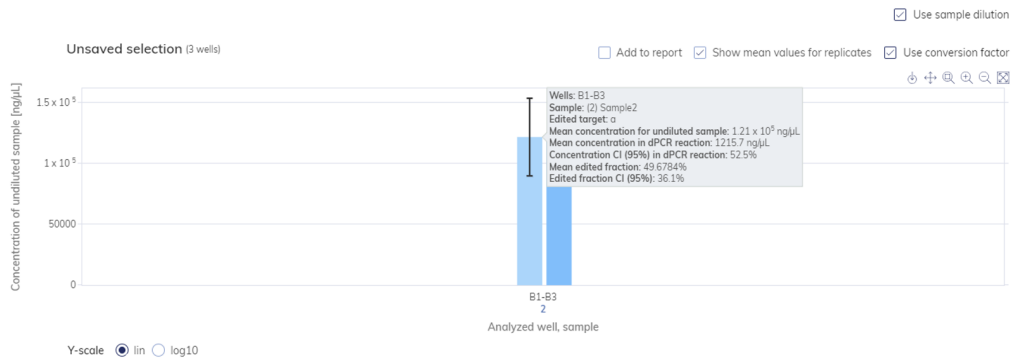

To add the Concentration diagram to the report, click **Add to report**. For more information on reports, see section “Reports”.

7.6.18. Copy number variation

The **Copy number variation** tab contains diagrams that visualize the data related to copied genes in targets of interest comparing to reference targets or reference sample. The analysis results are put into list views, heatmaps, point diagrams, and concentration diagrams.

Note: Amplitude multiplexing is not supported for Copy number variation analysis – targets associated in amplitude multiplexing mode (“Low” and “High”) are disabled during selection.

Setting up a copy number variation analysis with reference target

1. Click the applicable wells in the plate layout. For more information, see section “Selecting wells for analysis”.

2. Select the applicable reference target from the Reference target list.
3. Enter the number of copies per genome in the Copies/genome field for the target of interest in reference sample. The value should be between 1 and 99.
4. Select the applicable target that you want to investigate from the Target of interest list.
5. Select one or more reference targets from the Reference target(s) list.

Note: You can select more than one reference target.

- To view the results of the analysis, click **Show results**.
- The results are divided into several tabs. To view the contents of the tab, click the tab title.

Setting up a copy number variation analysis with reference sample

- Click the applicable wells in the plate layout. For more information, see section “Selecting wells for analysis”.

Absolute Quantification Mutation Detection Genome Editing **Copy Number Variation** Gene Expression

Select source of copy number variation (2 wells)

1 2 3 4 5 6 7 8 9 10 11 12

A B C D E F G H

Select all Unselect all Group as hyperwells Ungroup hyperwells

Select imaging step

1 2

CNV with reference sample CNV with reference target

CNV with reference sample allows checking how the copy number/genome of a target of interest varies from one sample to another in relation to the reference sample with a known copy number/genome for that particular target(s) of interest.

Reference sample * Copies/genome *

Select sample from the list

Target of interest *

Select reference sample first

Reference selection *

Select reference sample first

Reference target(s) *

Select reference sample first

Show results

- Select the applicable reference sample from the Reference sample list.
- Enter the number of copies per genome in the “Copies/genome” field for the target of interest in reference sample. The value should be between 1 and 99.
- Select the applicable target that you want to investigate from the Target of interest list.
- Select one or more reference targets from the Reference target(s) list.

Note: You can select more than one reference target.

- To view the results of the analysis, click **Show results**.
- The results are divided into several tabs. To view the contents of the tab, click the tab title.

List tab for copy number variation

The List tab contains a table with an overview of the analyzed wells. The following columns are available in the table:

- Well ID** – like A1, B2, when gradient was selected, there is also temperature in the well (temperature range instead of single one, if hyperwells were selected).
- Sample/NTC/Control** – This column shows the sample, NTC, or control name with its corresponding icon that identifies the sample or indicates whether the entry is an NTC or control. Reference samples are marked with the word “Ref”.
- Reaction mix** – This column contains the icon and the name of the Reaction mix.

4. **Target** – This column shows all target names with its corresponding target type.
5. **Conc. [copies/μL]** – This column shows the concentration assigned to each target or channel.

Note: Targets that were selected as target of interest (TOI) or reference target (Ref) are marked accordingly depending if CNV with reference target or sample is selected.
6. **CI (95%)** – This column shows the value of the confidence interval at a 95% confidence level.
 - a. When checkbox “Show mean values for replicates” is checked additionally two columns are displayed:
 - Mean conc. [copies/μL] – This column shows the mean concentration assigned to each target or channel per well for replicates.
 - CI (95%) – This column shows the value of the confidence interval at a 95% confidence level for the mean concentration.

Note: Columns related to Concentration and Mean concentration can be additionally divided into several sub-columns depending if dilution factor and/or conversion factor (described in sections “Dilution calculation option” and “Conversion factor”, accordingly) have been selected.
7. **Copies/genome** – This column shows the number of copies per genome in each of the targets of interest.
8. **CI (95%)** – This column shows the value of the confidence interval for the target of interest at a 95% confidence level.

List Heatmap Point diagram Concentration diagram Add to report Show mean values for replicates Export to CSV...

Sample/NTC/Control	Ref	Reaction Mix	Name	Target	IC	Type	Conc. [copies/μL]	CI (95%)	Copies/genome [copies/genome]	CI (95%)
A1 Sample1	Ref	iMix1 Ref. channel: ① 984-Ref	m	-	-	TOI	676.1	5.5%	99.0000	0%
			o	-	-	REF	682.0	5.5%	n.a.	-
			n	-	-	-	0.000	-	n.a.	-
			u	-	-	-	456.8	6.6%	n.a.	-
			y	-	-	-	0.000	-	n.a.	-
B1 Sample2		iMix1 Ref. channel: ① 984-Ref	m	-	-	TOI	676.1	5.5%	99.0000	11.0%
			o	-	-	REF	682.0	5.5%	n.a.	-
			n	-	-	-	0.000	-	n.a.	-
			u	-	-	-	456.8	6.6%	n.a.	-
			y	-	-	-	0.000	-	n.a.	-

List view for CNV with reference sample.

List Heatmap Point diagram Concentration diagram Add to report Show mean values for replicates Export to CSV...

Sample/NTC/Control	Ref	Reaction Mix	Name	Target	IC	Type	Conc. [copies/μL]	CI (95%)	Copies/genome [copies/genome]	CI (95%)
A1 Sample1		iMix1 Ref. channel: ① 984-Ref	o	-	-	TOI	682.0	5.5%	5.0441	7.8%
			m	-	-	REF	676.1	5.5%	5.0000	-
			n	-	-	-	0.000	-	n.a.	-
			u	-	-	-	456.8	6.6%	n.a.	-
			y	-	-	-	0.000	-	n.a.	-
B1 Sample2		iMix1 Ref. channel: ① 984-Ref	o	-	-	TOI	682.0	5.5%	5.0441	7.8%
			m	-	-	REF	676.1	5.5%	5.0000	-
			n	-	-	-	0.000	-	n.a.	-
			u	-	-	-	456.8	6.6%	n.a.	-
			y	-	-	-	0.000	-	n.a.	-

List view for CNV with reference target.

Replicates are treated different for multiplex and simplex test setup:

1. Multiplex test (configured target of interest and reference targets are part of the same reaction mix):
 - a. On the right side above the table, there is checkbox that allows the user to show mean values for replicates in addition. By default, the button is unchecked, and results are displayed without mean values. When the button is checked, the list view still shows independent rows for each selected well but replicates are grouped together. Replicates from the same group are next to each other in the list view. The list view is extended by four columns indicating following mean values:
 - Mean conc. [copies/ μ L] – mean concentration value
 - CI (95%) – CI of mean concentration as percentage
 - Mean copies/genome
 - CI (95%) – CI of mean mutation fraction as percentage

2. Simplex test (configured target of interest and reference targets are part of different reaction mixes):

For tests having the configured targets in different wells/reaction mixes, the mean result is calculated and shown for replicates in the selection. The list view is extended by four columns indicating following mean values:

- a. Mean conc. [copies/ μ L] – mean concentration value
- b. CI (95%) – CI of mean concentration as percentage
- c. Mean copies/genome
- d. CI (95%) – CI of mean mutation fraction as percentage

Note: If the selected analysis source contains replicates of the reference sample, the results can be calculated only by using mean results for replicates. In this case, the “Show mean values for replicates” checkbox is marked and cannot be changed. In this case, there is a warning message above the table and, when the user hovers on the checkbox, a tooltip appears to inform the user that selected analysis source contains replicates of the reference sample and result is calculated only by using mean results for replicates.

Note: When creating a report for this plate, the result list is automatically included in the report as soon as at least one dedicated diagram for copy number variation (heatmap, point diagram, and concentration diagram) is selected to be included. For more information on reports, see section “Reports”.

To export the results of the list view to an CSV file, click **Export to CSV**.

Heatmap tab for copy number variation

The **Heatmap** tab contains a heatmap that shows the number of copies per genome in each of the wells. If a well is not selected as a source for the analysis, the value is not displayed on the heatmap and its background color is gray.

To view an additional toolbar that enables actions related to the diagram, such as downloading the plot, hold the pointer over the diagram. For more details about the toolbar, refer to “Diagram options”.

To view detailed information about a particular well, point the cursor over the well. A tooltip with detailed information opens.

To view the mean values for replicates in multiplex tests, click **Show mean values for replicates**. For simplex tests, the mean values view is always shown for replicates and cannot be disabled.

Note: If the selected analysis source contains replicates of the reference sample, your results can be calculated only by using mean results for replicates. In this case, the “Show mean values for replicates” checkbox is marked and cannot be changed. When the user hovers on the checkbox, a tooltip appears to inform the user that selected analysis source contains replicates of the reference sample and result is calculated only by using mean results for replicates.

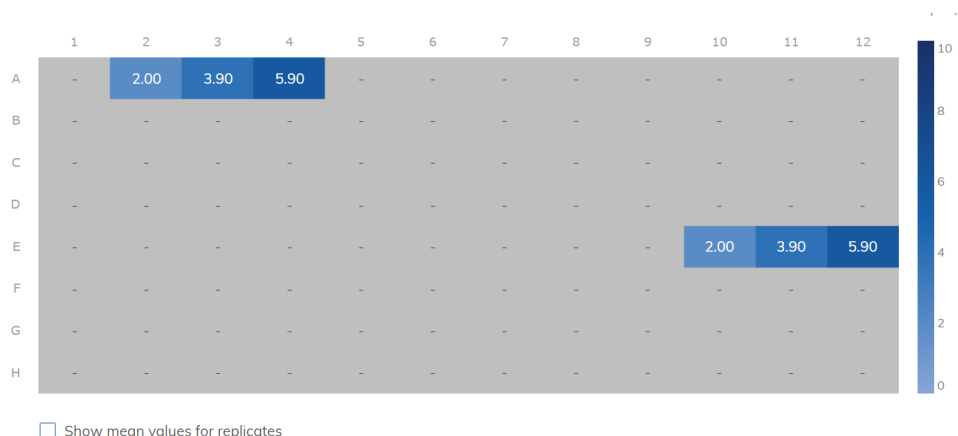

To add the heatmap to the report, click **Add to report**. For more information on reports, see section “Reports”.

Point diagram tab for copy number variation

The **Point diagram** tab shows the diagram that displays the number of copies per genome of the configured copy number variation test and the confidence intervals related to every value. A point diagram has two axes. The x axis shows the analyzed wells and samples, and the y axis represents the number of copies in each genome. A confidence interval displayed as an error bar is shown for each of the points on the diagram.

To view an additional toolbar that enables actions related to the diagram, such as downloading the plot, hold the pointer over the diagram. For more details about the toolbar, refer to “Diagram options”.

The y axis scale can be modified using the buttons located below each graph. To view the values on a linear scale, click **lin**. To view the values on a logarithmic scale, click **log10**.

The diagram shows the values as points with the CI as interval for the selected samples. In case that targets are in the same reaction mix, each sample is represented by 1 point. The point color reflects the color assigned to the corresponding target of interest.

The samples are sorted by sample ID but the reference sample of a test is always shown. The well IDs and sample IDs are labeled on the x axis.

In case that targets are in different reaction mixes each combination of target of interest and reference targets in one sample throughout the selected wells is shown in the diagram with a point for the result. To view detailed information, hold the mouse pointer over its corresponding point. A tooltip with detailed information opens.

To view the mean values for replicates, click **Show mean values for replicates**. If the user clicks into the checkbox to select the mean representation for replicates, the points of individual replicates disappear and only one point is shown at the sample label that represents the mean copies per genome value of the replicates. When there are no replicates within selected wells, the points do not change. The corresponding well IDs of the replicates are shown on the x axis. This is also applied in same

way by default to the view where targets are in different reaction mixes. In this case, individual replicate results are not available. Mean values are calculated and shown over all replicates that are included in the well selection only. If there are further replicates of the same sample that are not included in well selection, they are not considered in the calculated mean value and show their individual results values.

Note: If the selected analysis source contains replicates of the reference sample, the results can be calculated only by using mean results for replicates. In this case, the “Show mean values for replicates” checkbox is marked and cannot be changed. In this case, there is a warning message above the diagram title and, when the user hovers on the checkbox, a tooltip appears to inform the user that selected analysis source contains replicates of the reference sample and result is calculated only by using mean results for replicates.

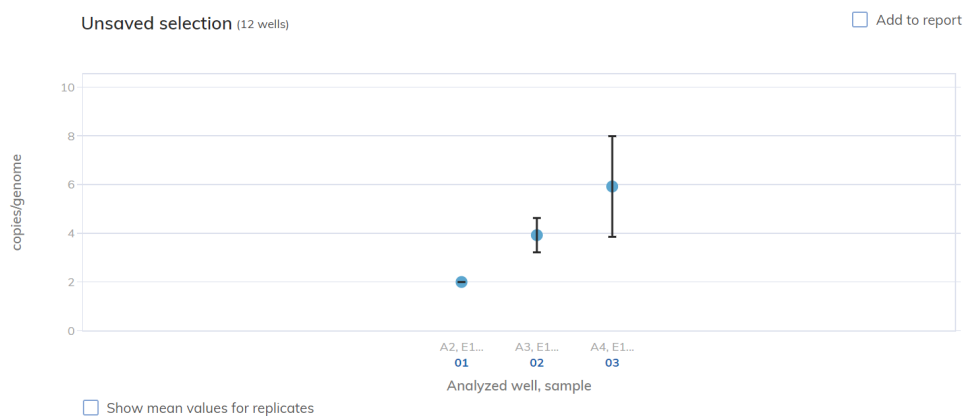

To add the point diagram to the report, click **Add to report**. For more information on reports, see section “Reports”.

Concentration diagram tab for copy number variation

The **Concentration diagram** tab shows the diagram that displays the concentration values of the configured copy number variation test and the confidence intervals related to every value. A concentration diagram has two axes.

1. X axis represents labels of wells and samples that it belongs to.
2. Y axis represents the concentration values for selected targets or channels for each well. A confidence interval displayed as an error bar is shown for each of the bars on the diagram.

The y axis scale can be modified using the buttons located below each graph. To view the values on a linear scale, click **lin**. To view the values on a logarithmic scale, click **log10**.

To view an additional toolbar that enables actions related to the diagram, such as downloading the plot, hold the pointer over the diagram. For more details about the toolbar, refer to “Diagram options”.

The Concentration diagram is a bar plot that presents two values:

1. Concentration value as bar
2. CI value as error bar

The diagram consists of all possible combinations. Each sample on the diagram is represented by the number of bars according to targets that was selected as a target of interest and reference targets. Samples on the diagram are sorted by the

sample ID. Target bars in the sample show one concentration bar for target of interest at first position and concentration bars for reference targets sorted by their well ID. The bar color reflects the color assigned to the corresponding targets. The sample ID is shown center-aligned below the bars.

The bar size is fixed if:

1. The reference targets and target of interests are situated on one well there is one well label for all that belongs to the same well.
2. The reference targets and target of interests are situated on two wells or more wells there are one well label per targets that are within this well.

When hovering over a bar in the diagram, a tooltip appears presenting details about the actual values of concentration and CI and results of tests.

To view the mean values for replicates on the diagram, click **Show mean values for replicates**. When this checkbox is checked, the concentration diagram shows bars that represents mean concentration value for replicates within the well selection. The label below the bar shows well positions that are included in the replicates value of mean concentration. On hovering on the bar, there is a tooltip with details about wells, sample, and target that are part of replicate group and the results are shown as mean result values with a corresponding mean label. This is also applied in same way by default to the view where targets are in different reaction mixes. In this case, individual replicate results are not available. When selected well has no replicates within all selected wells, individual result values are shown.

Note: If the selected analysis source contains replicates of the reference sample, your results can be calculated only by using mean results for replicates. In this case the “Show mean values for replicates” checkbox is marked and cannot be changed. In this case there is a warning message above the diagram title and, when the user hovers on the checkbox, a tooltip appears to inform the user that selected analysis source contains replicates of the reference sample and result is calculated only by using mean results for replicates.

3. There are two additional options that user can select. First option is Use sample dilution – as described in section “Dilution calculation option”, enables calculations related to dilution factor. Results in undiluted sample is additionally presented on well tiles, y axis scale is adjusted to results. Second option is Use conversion factor – as described in section “Conversion factor”, enables conversion of results into unit given by user. Results in converted unit replace standard ones on well tiles, y axis scale is adjusted to results.



To add the Concentration diagram to the report, click **Add to report**. For more information on reports, see section “Reports”.

7.6.19. Gene expression

The Software Suite analyzes the gene expression of the samples. The analysis results are put into list views, heatmaps, point diagrams, and concentration diagrams.

Note: Saving gene expression tests is not yet provided.

Note: Amplitude multiplexing is not supported for Gene expression analysis – targets in amplitude multiplexing mode (“Low” and “High”) are disabled during selection.

Setting up a gene expression analysis

1. Click the applicable wells in the plate layout.

The screenshot displays the software interface for setting up a gene expression analysis. At the top, there are tabs for 'Absolute Quantification', 'Mutation Detection', 'Genome Editing', 'Copy Number Variation', and 'Gene Expression', with 'Gene Expression' being the active tab. Below the tabs is a header 'Select source of gene expression (3 wells)'. The main area shows a 96-well plate layout with columns numbered 1 to 12 and rows labeled A to H. Each well contains a small circular icon representing a sample or control. To the right of the plate layout, there are several dropdown menus and buttons for configuration: 'Select imaging step' (with buttons for 1 and 2), 'Reference sample *' (with a dropdown menu and an information icon), 'Target of interest *' (with a dropdown menu and an information icon), 'Reference selection *' (with a dropdown menu and an information icon), and 'Reference target(s) *' (with a dropdown menu and an information icon). At the bottom right, there is a 'Show results' button.

2. Select the applicable reference sample from the Reference sample list.
3. Select the applicable target from the Target of interest list.
4. Select one or more reference targets from the Reference target(s) list.
5. To view the results of the analysis, click **Show results**.
6. The results are divided into several tabs. To view the contents of the tab, click the tab title.

List tab for gene expression

The List tab contains a table with an overview of the analyzed wells. The following columns are available in the table:

1. **Well ID** – like A1, B2, when gradient was selected there is also temperature in the well (temperature range instead of single one, if hyperwells were selected).
2. **Sample/NTC/Control Name** – This column shows the sample, NTC, or control name with its corresponding icon that identifies the sample or indicates whether the entry is an NTC or control. Reference samples are marked with the word “Ref”.
3. **Reaction mix** – This column contains the icon and the name of the reaction mix.

4. **Target** – This column shows all target names with its corresponding target type. Targets that were selected as target of interest (TOI) or reference target (Ref) are marked accordingly.
5. **Conc. [copies/μL]** – This column shows the concentration assigned to each target.
6. **CI (95%)** – This column shows the value of the confidence interval at a 95% confidence level.
 - a. When checkbox “Show mean values for replicates” is checked, additional two columns are displayed:
 - Mean conc. [copies/μL] – This column shows the mean concentration assigned to each target or channel per well for replicates.
 - CI (95%) – This column shows the value of the confidence interval at a 95% confidence level for the mean concentration.

Note: Columns related to Concentration and Mean concentration can be additionally divided into several sub-columns depending if dilution factor and/or conversion factor (described in sections “Dilution calculation option” and “Conversion factor”, accordingly) have been selected.

1. **Fold change** – This column shows the change in the level of gene expression in the sample.
2. **CI (95%)** – This column shows the value of the confidence interval for the fold change at a 95% confidence interval.
3. **Fold regulation** – This column shows the change in the level of gene expression compared to the reference sample.

Sample/NTC/Control	Ref	Reaction Mix	Name	Target IC	Type	Conc. [copies/μL]	CI (95%)	Fold change	CI (95%)	Fold regulation
A1 Sample1	Ref	mMix1 Ref channel (S) 98-Ref	m	-	TOI	67E.1	5.5%	1.0000	0%	1.0000
			a	-	REF	682.0	5.5%	n.a.	-	n.a.
			n	-	-	0.000	-	n.a.	-	n.a.
			u	-	-	45E.8	6.6%	n.a.	-	n.a.
			y	-	-	0.000	-	n.a.	-	n.a.
B1 Sample2		mMix1 Ref channel (S) 98-Ref	m	-	TOI	67E.1	5.5%	1.0000	11.0%	1.0000
			a	-	REF	682.0	5.5%	n.a.	-	n.a.
			n	-	-	0.000	-	n.a.	-	n.a.
			u	-	-	45E.8	6.6%	n.a.	-	n.a.
			y	-	-	0.000	-	n.a.	-	n.a.

Replicates are treated different for multiplex and simplex test setup:

1. Multiplex test (configured target of interest and reference targets are part of the same reaction mix):
 - a. On the right side above the table, there is checkbox that allows the user to show mean values for replicates in addition. By default, the button is unchecked, and results are displayed without mean values. When the button is checked, the list view still shows independent rows for each selected well, but replicates are grouped together. Replicates from the same group are next to each other in the list view. The list view is extended by five columns indicating following mean values:
 - Mean conc. [copies/μL] – mean concentration value
 - CI (95%) – CI of mean concentration as percentage
 - Mean fold change

- CI (95%) – CI of mean fold change as percentage
- Mean fold regulation

2. Simplex test (configured target of interest and reference targets are part of different reaction mixes):

- For tests having the configured targets in different wells/reaction mixes, the mean result is calculated and shown for replicates in the selection. The list view is extended by four columns indicating following mean values:
 - Mean conc. [copies/ μ L] – mean concentration value
 - CI (95%) – CI of mean concentration as percentage
 - Mean fold change
 - CI (95%) – CI of mean fold change as percentage
 - Mean fold regulation

Note: If the selected analysis source contains replicates of the reference sample, the results can be calculated only by using mean results for replicates. In this case, the “Show mean values for replicates” checkbox is marked and cannot be changed. In this case, there is a warning message above the table, and when the user hovers on the checkbox, a tooltip appears to inform the user that selected analysis source contains replicates of the reference sample and result is calculated only by using mean results for replicates.

To export the results to an CSV file, click **Export to CSV** and select **Current results**.

Heatmap for gene expression

The **Heatmap** tab contains a heatmap view that shows the fold change in each of the wells. If a well is not selected as a source for the analysis, the value is not displayed on the heatmap and its background color is gray. In case that a fold change is not applicable for a well, n.a. is shown.

To view an additional toolbar that enables actions related to the diagram, such as downloading the plot, hold the pointer over the diagram. For more details about the toolbar, refer to “Diagram options”.

To view detailed information about a particular well, point the cursor over the well. A tooltip with detailed information opens.

To view the mean values for replicates in multiplex tests, click **Show mean values for replicates**. For simplex tests, the mean values view is always shown for replicates and cannot be disabled.

Note: If the selected analysis source contains replicates of the reference sample, the results can be calculated only by using mean results for replicates. In this case, the “Show mean values for replicates” checkbox is marked and cannot be changed. When the user hovers on the checkbox, a tooltip appears to inform the user that selected analysis source contains replicates of the reference sample and result is calculated only by using mean results for replicates.

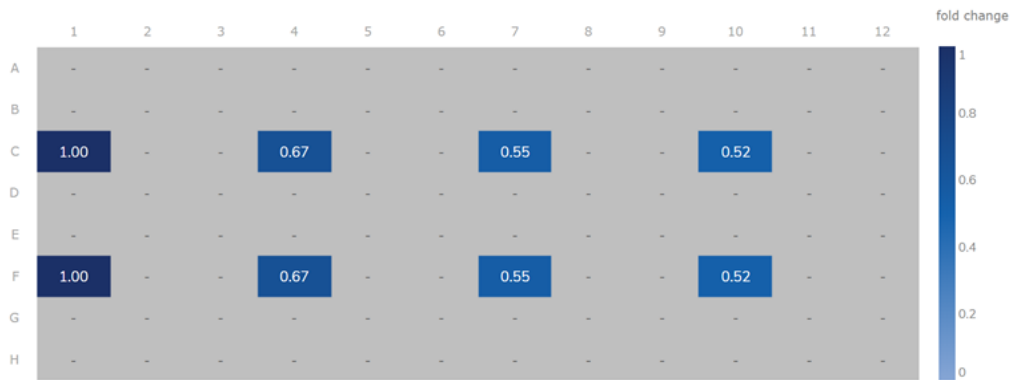

To add the heatmap to the report, click **Add to report**. For more information on reports, see section “Reports”.

Point diagram for gene expression

The **Point diagram tab** shows a point diagram view that displays the fold change values of configured gene expression test and the confidence intervals related to every value. A point diagram has two axes. The x axis shows the analyzed wells and samples, and the y axis represents the fold change. A confidence interval displayed as an error bar is shown for each of the points on the diagram.

To view an additional toolbar that enables actions related to the diagram, such as downloading the plot, hold the pointer over the diagram. For more details about the toolbar, refer to “Diagram options”.

The y axis scale can be modified using the buttons located below each graph. The buttons are visible when you hold the pointer over a graph. To view the values on a linear scale, click **lin**. To view the values on a logarithmic scale, click **log10**.

The diagram shows the values as points with the CI as interval for the selected samples. In case that the targets are in the same reaction mix, each sample is represented by 1 point. The point color reflects the color assigned to the corresponding target of interest.

The samples are sorted by sample ID but the reference sample of a test is always shown first. The well IDs and sample IDs are labeled on the x axis.

In case that targets are in different reaction mixes, each combination of target of interest and reference targets in one sample throughout the selected wells is shown in the diagram with a point for the result. To view detailed information, hold the mouse pointer over its corresponding point. A tooltip with detailed information opens.

To view the mean values for replicates, click **Show mean values for replicates**. If the user clicks into the checkbox to select the mean representation for replicates, the points of individual replicates disappear and only one point is shown at the sample label that represents the mean fold change value of the replicates. When there are no replicates within selected wells the points do not change. The corresponding well IDs of the replicates are shown on the x axis. This is also applied in same way by default to the view where targets are in different reaction mixes. In this case, individual replicate results are not available. Mean values are calculated and shown over all replicates that are included in the well selection only. If there are further replicates of the same sample that are not included in well selection, they are not considered in the calculated mean value and show their individual results values.

Note: If the selected analysis source contains replicates of the reference sample, the results can be calculated only by using mean results for replicates. In this case, the “Show mean values for replicates” checkbox is marked and cannot be changed. In this case, there is a warning message above the diagram title and, when the user hovers on the checkbox, a tooltip appears to inform the user that selected analysis source contains replicates of the reference sample and result is calculated only by using mean results for replicates.

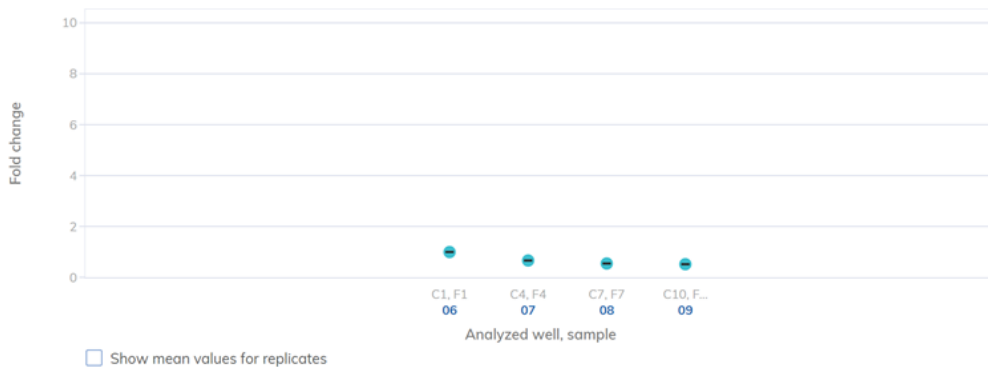

To add any of the point diagrams to the report, click **Add to report** next to the corresponding diagram. For more information on reports, see section “Reports”.

Concentration diagram for gene expression

The concentration diagram tab shows the diagram that displays the concentration values of the configured gene expression test and the confidence intervals related to every value. A concentration diagram has two axes.

1. X axis represents labels of wells and samples that it belongs to.
2. Y axis represents the concentration values for selected targets or channels for each well. A confidence interval displayed as an error bar is shown for each of the bars on the diagram.

The y axis scale can be modified using the buttons located below each graph. The buttons are visible when you hold the pointer over a graph. To view the values on a linear scale, click **lin**. To view the values on a logarithmic scale, click **log10**.

To view an additional toolbar that enables actions related to the diagram, such as downloading the plot, hold the pointer over the diagram. For more details about the toolbar, refer to “Diagram options”.

The Concentration diagram is a bar plot which presents two values:

1. Concentration value as bar
2. CI value as bar

The diagram consists of all possible combinations. Each sample on the diagram is represented by the number of bars according to targets that was selected as a target of interest and reference targets. Samples on the diagram are sorted by the sample ID. Target bars in the sample show one concentration bar for target of interest at first position and concentration bars for reference targets sorted by their well ID. The bar color reflects the color assigned to the corresponding targets. The sample ID is shown center-aligned below the bars.

The bar size is fixed if:

1. The reference targets and target of interests are situated on one well there is one well label for all that belongs to the same well.
2. The reference targets and target of interests are situated on two wells or more wells there are one well label per targets that are within this well.

When hovering over a bar in the diagram, a tooltip appears presenting details about the actual values of concentration and CI and results of tests.

To view the mean values for replicates on the diagram, click **Show mean values for replicates**. When this checkbox is checked, the concentration diagram shows bars that represents mean concentration value for replicates within the well selection. The label below the bar shows well positions that are included in the replicates value of mean concentration. When hovering on the bar, there is a tooltip with details about wells, sample and target that are part of replicate group and the results are shown as mean result values with a corresponding mean-label. This is also applied in same way by default to the view where targets are in different reaction mixes. In this case individual replicate results are not available. When selected well has no replicates within all selected wells, individual result values are shown.

Note: If the selected analysis source contains replicates of the reference sample, the results can be calculated only by using mean results for replicates. In this case, the “Show mean values for replicates” checkbox is marked and cannot be changed. In this case, there is a warning message above the diagram title and, when the user hovers on the checkbox, a tooltip appears to inform the user that selected analysis source contains replicates of the reference sample and result is calculated only by using mean results for replicates.

3. There are two additional options that user can select. First option is “Use sample dilution” – as described in section “Dilution calculation option”, enables calculations related to dilution factor. Results in undiluted sample is additionally presented on well tiles, y axis scale is adjusted to results. Second option is “Use conversion factor” – as described in section “Conversion factor”, enables conversion of results into unit given by user. Results in converted unit replace standard ones on well tiles, y axis scale is adjusted to results.

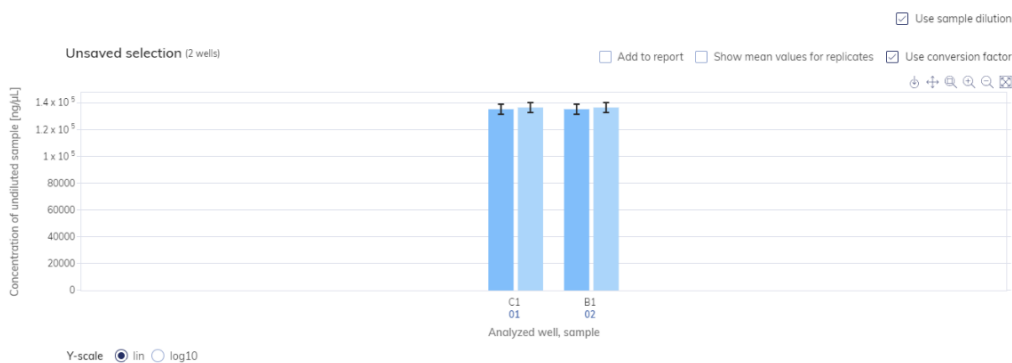

To add the concentration diagram to the report, click **Add to report**. For more information on reports, see section “Reports”.

7.7. Reports

In the QIAcuity Software Suite, user can create reports about your analysis results of a plate. All created reports remain accessible in the Software Suite and can be downloaded. Only unsigned reports can be deleted.

7.7.1. Creating a new report for a plate from the analysis environment

To create a new report from your analysis results, follow these steps:

1. Enter the Analysis environment of a finished plate. For more information about analyzing a plate, see “Analysis”.
2. To include a diagram or table of the analysis in the report, check the **Add to report** box of the corresponding diagram you want to include. Checking this box saves and pre-selects the corresponding diagram in the report.



Example of a diagram to be included in a report.

Note: In case of Custom analysis of 2D Scatterplot, user can add/remove whole overview as one element to report.

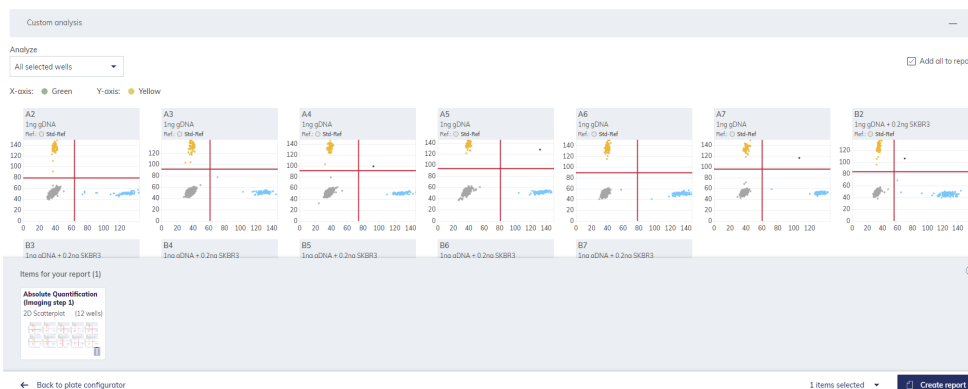

Example of a 2D Scatterplot Custom analysis overview to be included in a report.

Note: The total number of pre-selected diagrams for the report is always shown in the footer. The number of diagrams/tables to be included in one report for a plate is not limited but impact report generation time.

After reaching 301 items in report system will present warnings, that report generation will take several minutes and user should not log out and ensure system will not automatically log that user out.

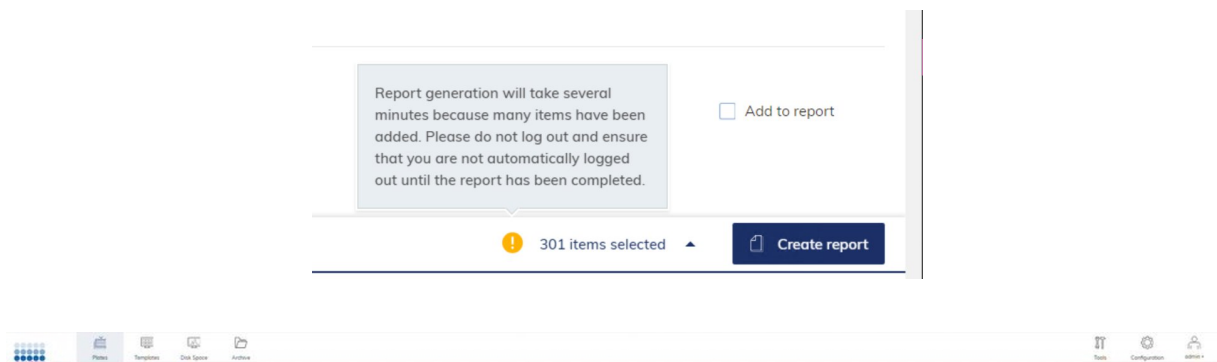

3. To remove the pre-selection of diagram, clear the **Add to report** box.
4. Click the arrow icon ▲ next to the number of selected graphs in the footer to open a preview window of all the preselected diagrams and use the 🗑️ icon to delete a diagram from the list of your diagrams to be included in the report. Use the ✕ icon in the preview window or ▼ icon in the footer to close the preview window.
Note: Clicking the ⬅️ Back to plates icon opens the plates overview screen and preselected diagrams for this plate will be lost.
Important: Once in the Create report window to perform the next step, going back to the analysis view of the plate loses the list of preselected diagram.
5. Click **Create report**.
6. In the Create report dialog box, select which information to include in the report. By default, all options are selected.

Create Report

Report name * Characters left: 113

Plate report

Select report elements

Run details
Author, Start and end time, Run steps, Run status, Software & Instrument version

Plate general data
Plate name, type, description, labels, plate owners, barcode

Plate layout
List of all the elements added to each well

Reaction mixes list
List of all your defined reaction mixes with details about each target

Comments
More information/ details / description about the report Characters left: 256

ⓘ During report generation new browser window will open. You can continue using your browser, but don't close this new window until report is done generating.

Create Report view for a plate.

7. Use this table as a guide in selecting which information to include in the report.

Table 15. Report elements

Element	Description
Report name	Every Report needs a specific name, without special characters ~ ' " ! @ ^ () = [] { } ; , < > \ .
Run details	Author, Start and end time, Run steps, Run status, Software & Instrument version
Plate general data	Plate name, type, description, plate owners, labels, barcode
Plate layout	List of all the elements added to each well
Reaction mixes list	List of all your defined reaction mixes with details about each target
Comments	More information/details/descriptions

Important: Clicking the  icon opens the plate analysis view but the preselected diagrams will be lost!

- To finish creating the report, click **Generate report PDF**.
- New window will appear where report is created and automatically downloaded in the download folder of the PC as a PDF file. In meantime user can normally operate the application. After successful generation, user is informed and window should be closed.

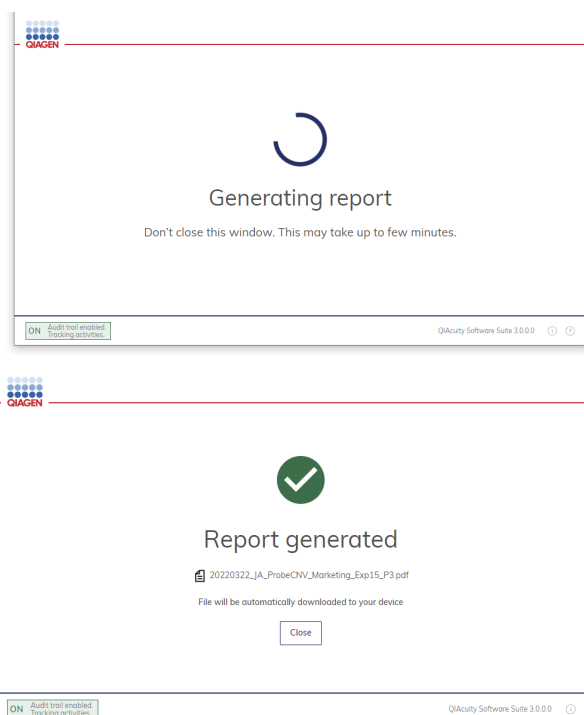

- The report is stored in the Software Suite and accessible via the report environment of the plate.

7.7.2. Managing reports of a plate in the report environment

The report environment of a plate provides an overview of all created reports for this plate. User can use this environment to manage the created reports. To enter the report environment of a plate, go to the plate tile in the plates overview. Click the three-dotted icon, then click **Reports**.

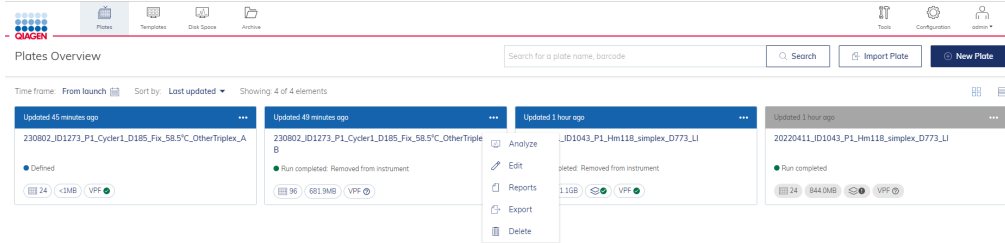

Note: Alternatively, click the plate name in the tile to enter the plate configurator view, then click **Reports** in the context menu.

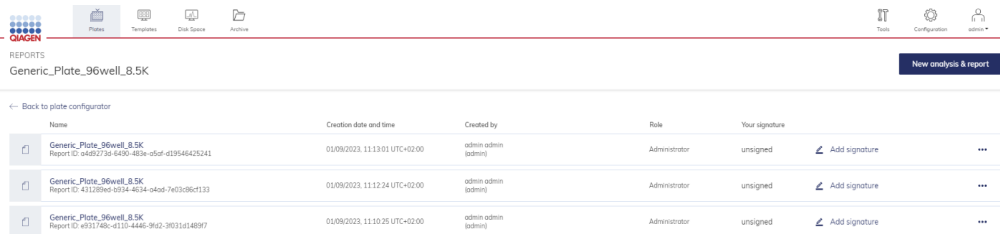

Use the following table as a guide in managing your created reports for a specific plate.

Table 16. Action button in report environment

Action	Description
Download as PDF	Downloads the report in PDF format
Delete report	Delete the report
New analysis & report	Back to Analysis view of this plate
Back to plates	Back to plates overview screen
Add signature	Add signature to the report
Check signers	List signers: user name, role, date, and reason

7.7.3. Sign report

To support GMP/GLP requirements, the QIAcuity system provides an option to electronically sign existing reports. To do so, the user has to follow the steps given below.

1. Go to report list view.

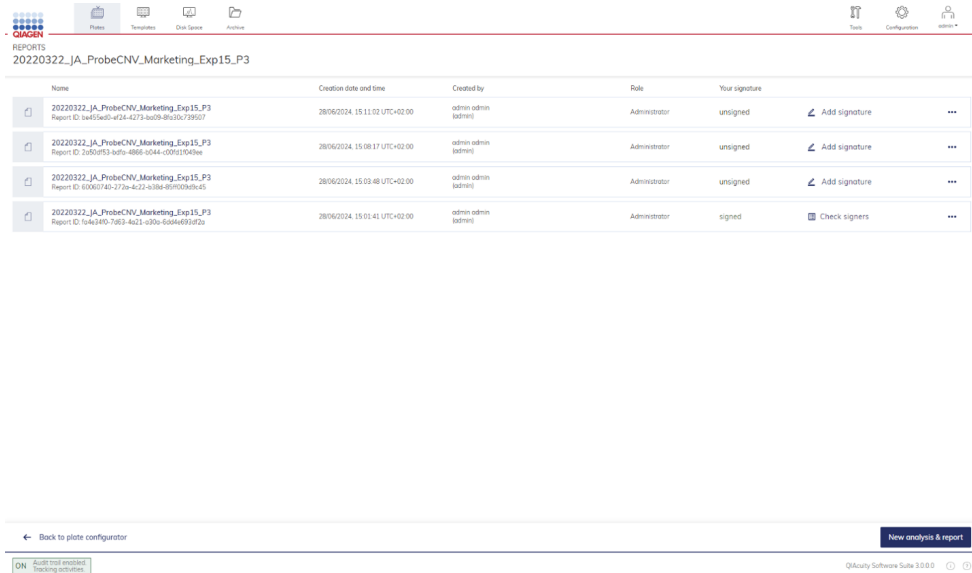

2. Select the **Add signature** button.

 Add signature

3. A pop-up window will appear with confirmation request. User needs to download and read report, then:
 - a. Add user login
 - b. Add password
 - c. Add reason for signing and finally click **Sign the report** button.

Sign the report

After signing the report removing the signature and signed report will not be possible. The signature will contain your name, surname, role, date and reason for signing. All this information will be added to the report (PDF).

- 1 Download and read report *
[Download report](#)
- 2 Add login *

Provide your login used for QIAcuity access
- 3 Add password *

Provide your password used for QIAcuity access
- 4 Add reason for signing * Characters left: 30

[Cancel](#) [Sign the report](#)

If wrong password will be typed user will be presented with following information:

Sign the report ✕

After signing the report removing the signature and signed report will not be possible. The signature will contain your name, surname, role, date and reason for signing. All this information will be added to the report (PDF).

- 1. Download and read report ***
- 2. Add login ***

Provide your login used for QIAcuity access
- 3. Add password ***
 👁
The password is incorrect.

❌ **Incorrect password**
 You've got 2 more attempts before you are logged out.
- 4. Add reason for signing *** Characters left: 16

After three incorrect attempts in adding password, user will be automatically logged out and a corresponding event is tracked in the audit trail.

1. When the report is signed, an appropriate message will be presented on the report list and the **Add signature** button will be disabled.
2. It is enabled in the system if more than one user can sign the report, but the user cannot overwrite his signature for an already signed report.

☐	Name	Creation date and time	Created by	Role	Your signature	
☐	Generic_Plate_96well_8.SK <small>Report ID: 04820734-6430-4534-9a5d-4d1956812821</small>	01/09/2023 11:13:01 UTC+02:00	admin (admin admin)	Administrator	signed	Check signers
☐	Generic_Plate_96well_8.SK <small>Report ID: 41123800-3934-4624-e48e-7d93e90c1232</small>	01/09/2023 11:12:24 UTC+02:00	admin (admin admin)	Administrator	unsigned	Add signature
☐	Generic_Plate_96well_8.SK <small>Report ID: 4931-748e-4130-4448-9f62-3c331d54897</small>	01/09/2023 11:10:25 UTC+02:00	admin (admin admin)	Administrator	unsigned	Add signature

When the report is signed, a user has an option to check who has performed such action. To do so, follow the instructions below:

1. Go to report list view.
2. Click the **Check signers** button.
3. A pop-up window will appear with information about signers.
 - a. Name and surname (Login in brackets)
 - b. Role
 - c. Date and time of signature (taking into account UTC timezones)

d. Reason (of signing)

Signers			
Name	Role	Date and time	Reason
1. John Doe (jodoe)	Administrator	01/09/2023, 11:56:23 UTC+02:00	my reason 1
2. admin admin (admin)	Administrator	01/09/2023, 11:56:55 UTC+02:00	my reason 2

[Close](#)

Moreover, during PDF export of the signed report, an additional page with information about signers (same as the list above) is added at the end of the document: name and surname (login name), role, and date of signature.



Signers

Name	Role	Date and time	Reason
1. John Doe (jodoe)	Administrator	01/09/2023, 11:56:23 UTC+02:00	my reason 1
2. admin admin (admin)	Administrator	01/09/2023, 11:56:55 UTC+02:00	my reason 2

Sample To Insight

Generated by admin admin (admin) on 01.09.2023 11:12:24 UTC+02:00
via QIAcuity Software Suite 2.5

7.7.4. Run details in report

On the first page of report in section Run details, all information about particular run steps are listed in table:



TestPlate

23/10/2023, 15:59:49 UTC+02:00

Plate ID: 2e65b2b1-0bf1-4527-b101-ca73eb7fa759
 Report ID: fb8bc923-a0e2-489b-86fa-d3db6ea19546
 Author: admin admin (admin)

Run details

	Run step	Software Suite version	Instrument ID	CSW version	Date and time
1	Run started	2.5.0.0	qiacity-00485	CSW 2.5.0.24	23/10/2023, 14:48:55 UTC+02:00
2	Priming started	2.5.0.0	qiacity-00485	CSW 2.5.0.24	23/10/2023, 14:51:56 UTC+02:00
3	Priming completed	2.5.0.0	qiacity-00485	CSW 2.5.0.24	23/10/2023, 14:56:57 UTC+02:00
4	Cycling started	2.5.0.0	qiacity-00485	CSW 2.5.0.24	23/10/2023, 15:02:12 UTC+02:00
5	Cycling completed	2.5.0.0	qiacity-00485	CSW 2.5.0.24	23/10/2023, 15:08:59 UTC+02:00
6	Imaging started	2.5.0.0	qiacity-00485	CSW 2.5.0.24	23/10/2023, 15:09:32 UTC+02:00
7	Imaging completed	2.5.0.0	qiacity-00485	CSW 2.5.0.24	23/10/2023, 15:17:03 UTC+02:00
8	Run completed	2.5.0.0	qiacity-00485	CSW 2.5.0.24	23/10/2023, 15:19:04 UTC+02:00

Where Instrument ID is the name if the instrument connected to the Software Suite:



Plates
Templates
Disk Space
Archive

Tools
Configuration
Users

Configuration

Instrument name	Instrument name	
Archive	Instrument ID	Device name
User Management	instrument550	CSW10
Audit Trail		

ON Audit trail enabled. Tracking activities.

QIAcuity Software Suite 2.5 ⓘ ?

While some plate general data are now presented on second page of the report:



Generic_Plate_96well_8.5K

Plate general data

Plate name Generic_Plate_96well_8.5K
● Plate upgraded
Plate type Nanoplate 8.5K 96-well
Barcode -
Labels -
VPF ● Not applied
Description -

Plate Owners

User name	User login	Status
admin admin	admin	active

Sample To Insight
2 / 21
Generated by admin admin (admin) on 01/09/2023, 11:10:25 UTC+02:00
via QIAcuity Software Suite 2.5

Note: For plates from older Software Suite versions, information in columns Software Suite version, Instrument ID, and CSW version are not available – only run steps and date and time are presented:



23044553637

01/09/2023, 14:52:32 UTC+02:00

Plate ID: eac30502-3cfe-4817-9705-62648cc4519a
 Report ID: a0f2b80e-acb8-4168-883f-067eb5454ce7
 Author: admin admin (admin)

Run details

	Run step	Software Suite version	Instrument ID	CSW version	Date and time
1	Run started	n/a ¹⁾	n/a ¹⁾	n/a ¹⁾	25/04/2023, 14:02:54 UTC+02:00
2	Priming started	n/a ¹⁾	n/a ¹⁾	n/a ¹⁾	25/04/2023, 14:04:19 UTC+02:00
3	Priming completed	n/a ¹⁾	n/a ¹⁾	n/a ¹⁾	25/04/2023, 14:22:08 UTC+02:00
4	Cycling started	n/a ¹⁾	n/a ¹⁾	n/a ¹⁾	25/04/2023, 14:28:31 UTC+02:00
5	Cycling completed	n/a ¹⁾	n/a ¹⁾	n/a ¹⁾	25/04/2023, 15:24:26 UTC+02:00
6	Imaging started	n/a ¹⁾	n/a ¹⁾	n/a ¹⁾	25/04/2023, 15:30:24 UTC+02:00
7	Imaging completed	n/a ¹⁾	n/a ¹⁾	n/a ¹⁾	25/04/2023, 15:51:13 UTC+02:00
8	Run completed	n/a ¹⁾	n/a ¹⁾	n/a ¹⁾	25/04/2023, 15:51:29 UTC+02:00

1) SW version, Instrument ID and CSW version before software version 2.5 are not available

Sample To Insight
1 / 8
Generated by admin admin (admin) on 01/09/2023, 14:52:32 UTC+02:00
via QIAcuity Software Suite 2.5

7.8. Archive

In the QIAcuity Software Suite, user can set up an archive on an external drive. This will allow you to store the old plates and save disk space on the laptop.

Only the user with Administrator role can set up an archive; to do so, go to **Configuration** and select the **Archive** tab:

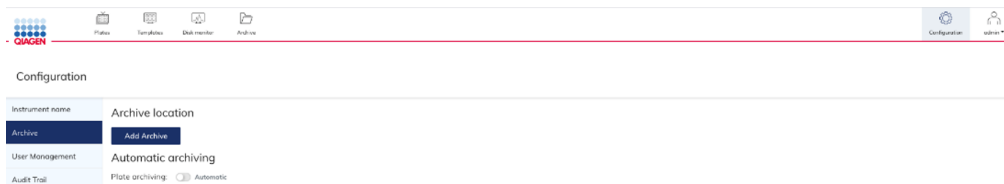

When **Add archive** is clicked, the user can provide a path to the external drive and click **Save**.

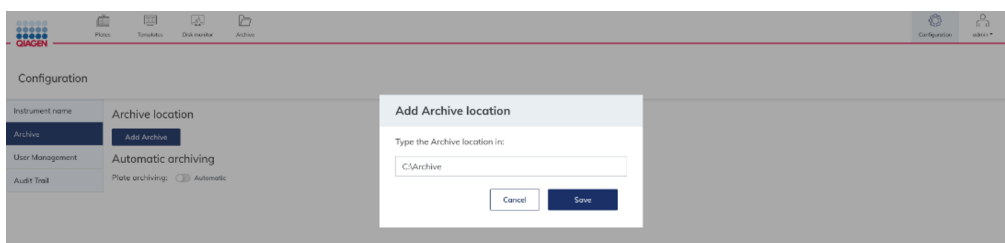

When the archive is configured, suitable information is presented on the Archive configuration screen.

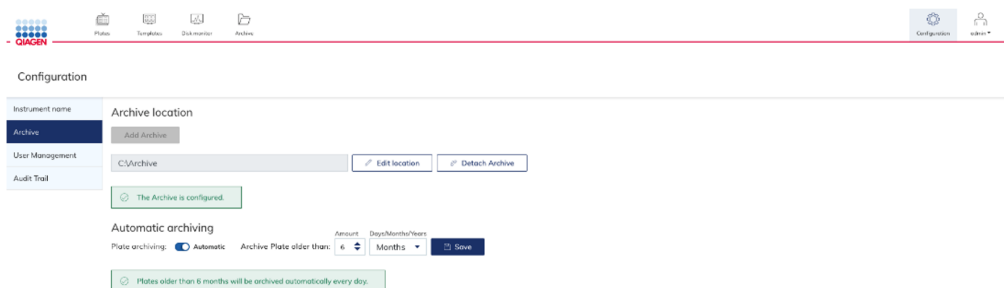

Configuring network drive as archive

User can set network as archive location. It is required to make several changes in operating system first:

1. On the PC where the archive folder will be stored, right-click the shared folder and go to **Properties**, then go to **Sharing** tab and update in following way:

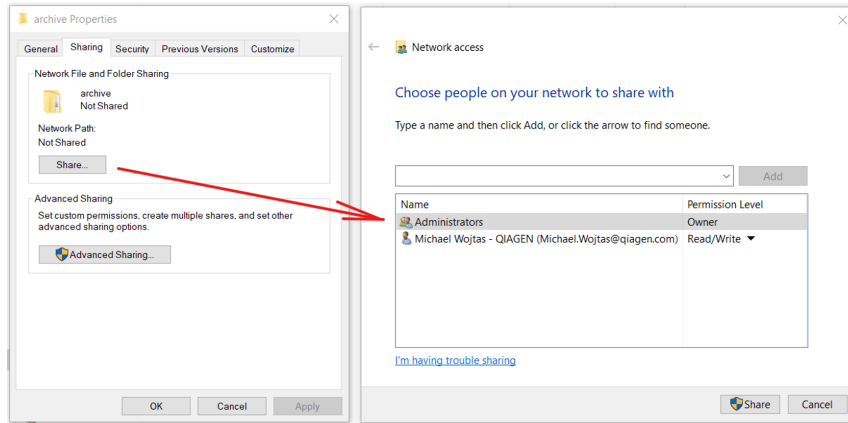

It is required to create new user and add it to permissions. User can be created through standard Windows user management or using drop-down from picture above and choose **Add**.

Created user can have basic permissions and does not need to have administrator rights, but it is required to set the permission level while sharing to "Read/Write" (as on the picture above). The credentials should be remembered, as those will be used to access the network drive from the QIAcuity Software Suite server.

2. On the QIAcuity Software Suite server machine (where the Software Suite is installed), the Software Suite must be set up to run as a user who has access to the network drive. To do so:
 - a. Open the Properties window for the **C:\Program Files (x86)\QIAcuity Software Suite** directory. Go to **Security** tab, then press **Edit**.

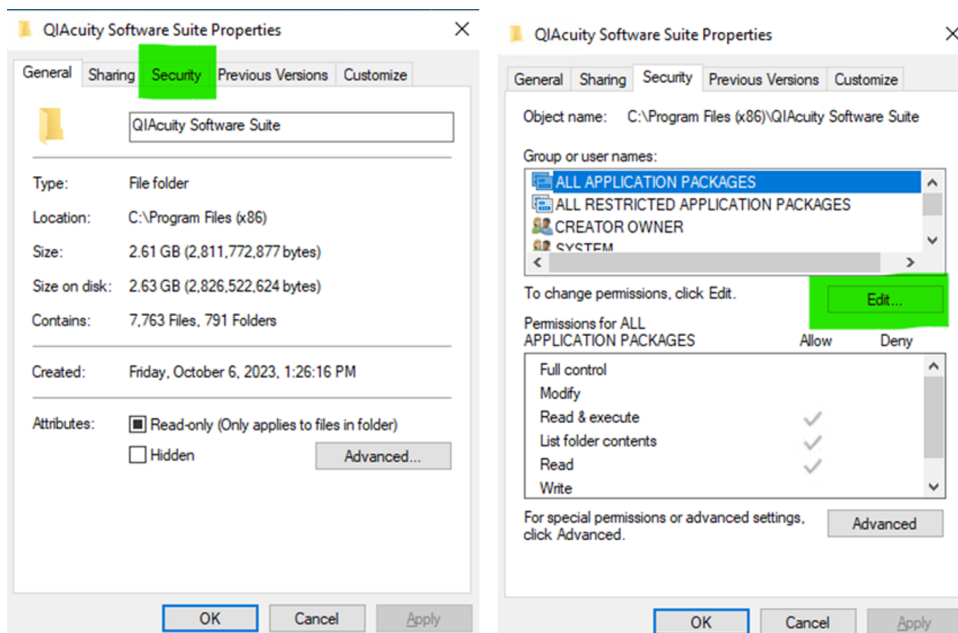

- b. Press **Add**. In the new pop-up window, enter the Windows User that will be used to run the Software Suite and click **Check names** to make sure the name is correct and then press **OK**.

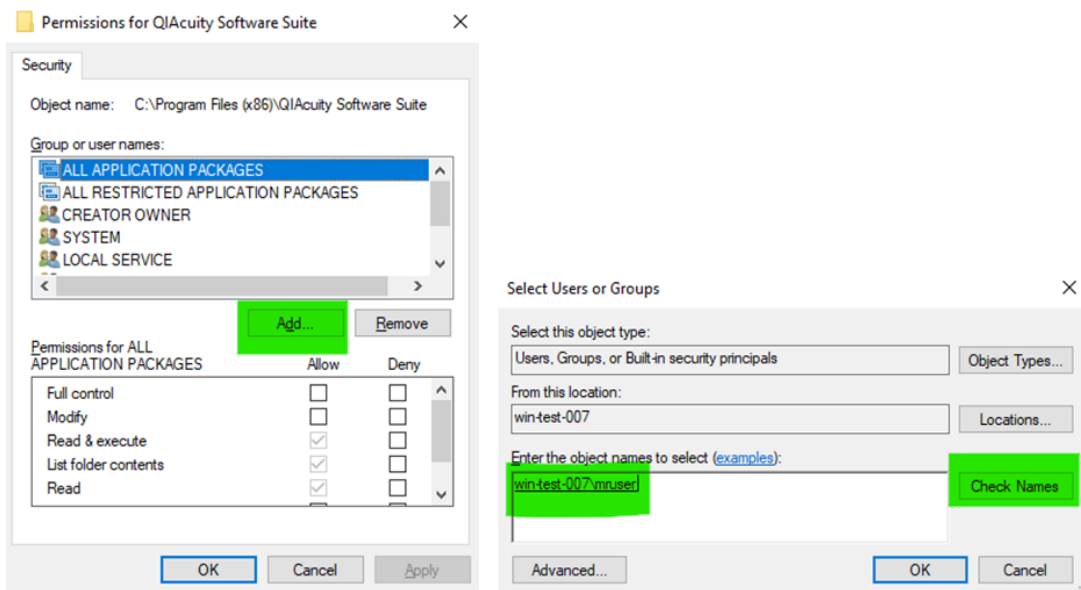

- c. Back in the Security window, check "Full control" permission for the added user and press **OK**.

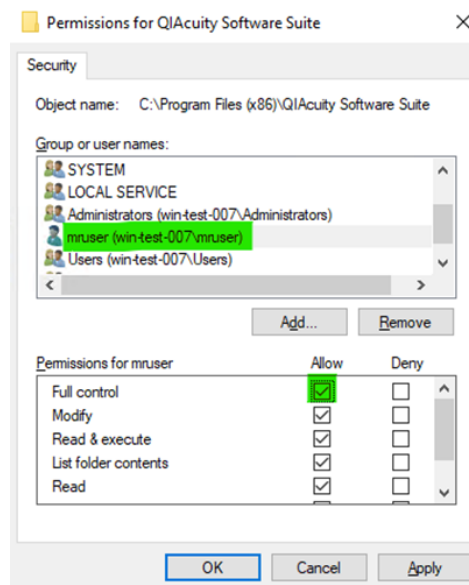

- d. Open the Services application: press the windows key, type "Services" and press the Enter key. Locate "QlAcuitySuite Service", right click, and choose **Properties**:

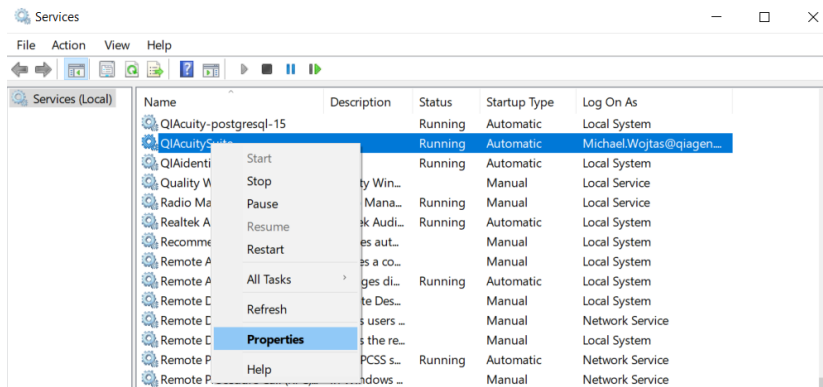

- e. In the new window, go to **Log On** tab and click **Browse** button:

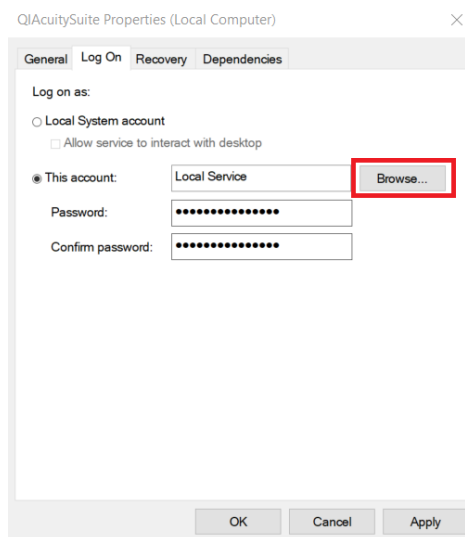

- f. In the new pop-up window, select the same user as in step 2b, click **Check names** and click **OK**. Provide password and confirm password in the inputs and click **OK**.

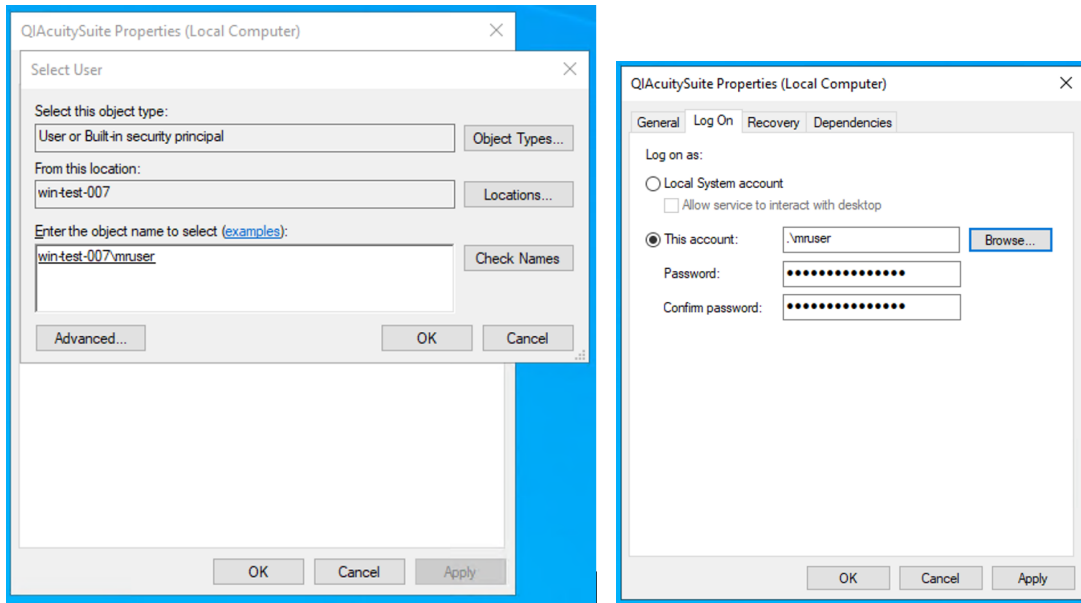

- g. Restart the service, by right clicking the QIAcuity Software Suite service in the Services window and click Restart (if the services window is not present, press CTRL + SHIFT + ESC on the keyboard). Wait a while (~5 min), for the service to boot up.

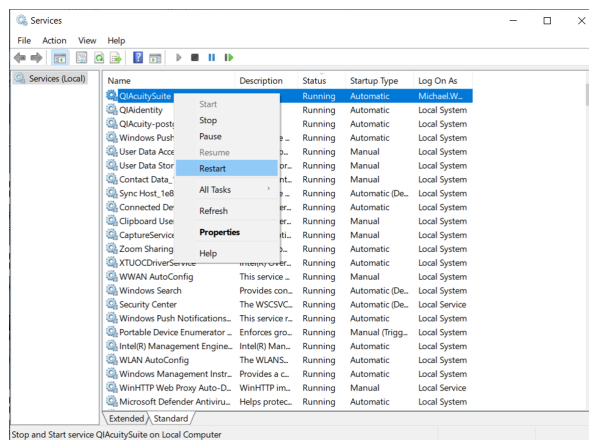

- On the QIAcuity Software Suite server machine (where the Software Suite is installed), press the windows button on keyboard, type credential manager, and press enter. In the newly opened window, choose **Windows Credentials** and click **Add a Windows Credential**.

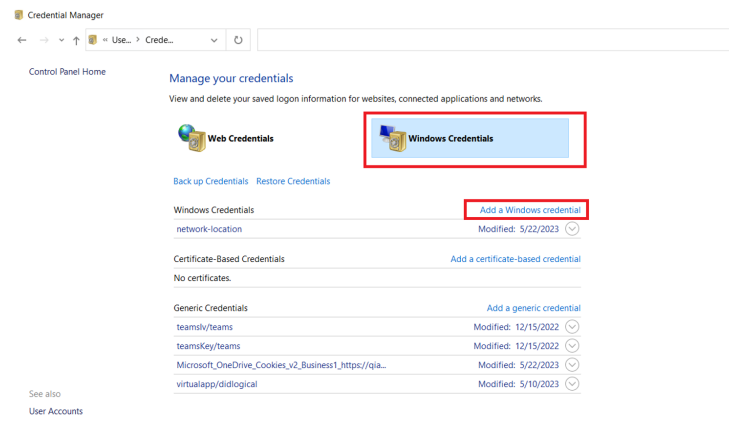

- In the newly opened window, provide server UNC (Universal Naming Convection) address and reuse credentials user name and password given above. It is important to specify only the server's name, without detailed path to archive folder.

For example, the path to archive is `\\DESKTOP-ABD324\someFolder\anotherFolder`, then in the Internet or network address only `\\DESKTOP-ABD324` should be typed:

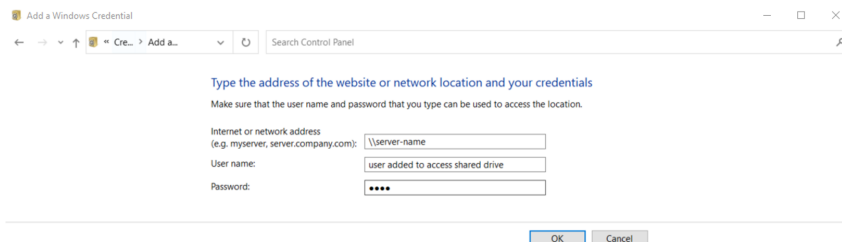

- Finally, in the Software Suite, in **Archive** tab in configuration, specify the network drive/folder using UNC format (`\\<server name>\<share point>\<path to resource>`) and click **Save**.

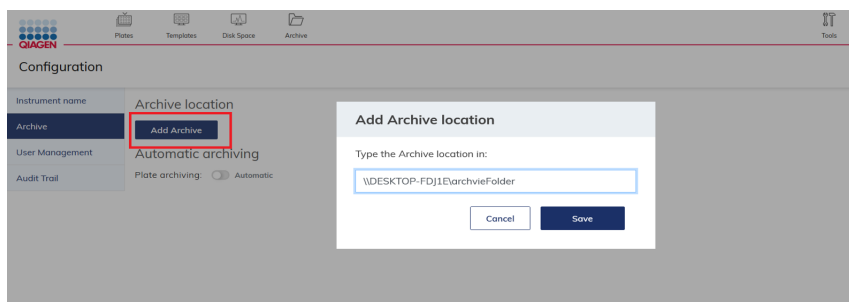

7.8.1. Automatic archiving

When the archive is set up, the administrator can turn on automatic plate archiving. It will automatically move plates older than the selected time duration to the archive. The default value is 6 months. When automatic archiving is turned on, suitable information is displayed on the Archive Configuration screen.

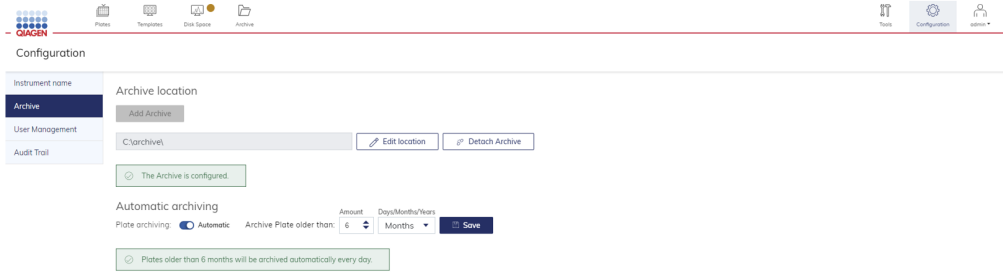

Note: Automatic archiving is running at 1 am every day.

7.8.2. Manual plate archiving

When the archive is set up, the user can manually move the plate to the archive. To do so, click the three dots (...) on any of the plates on the Plates Overview screen and select **Archive**. The plate will be moved to the archive.

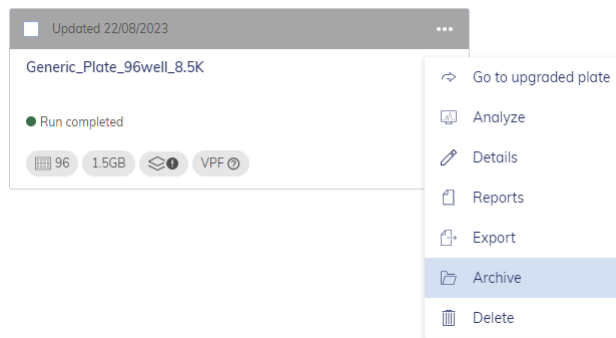

Note: Archiving plates can take a while depending on the speed of data transfer to the external drive.

7.8.3. Bulk plate archiving

From the Software Suite version 2.5 onwards, there is possibility to bulk archive plates. To bulk archive plates, user needs to select plates:

1. One by one, using checkboxes in upper left corner of each plate:

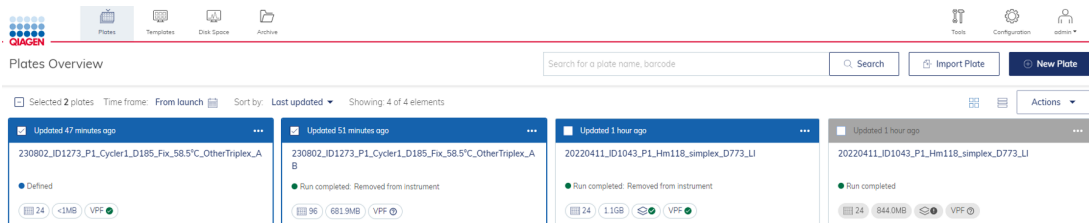

2. Using checkbox "Select all plates" selects all plates on plate overview and then adjust selection using checkboxes on plates:

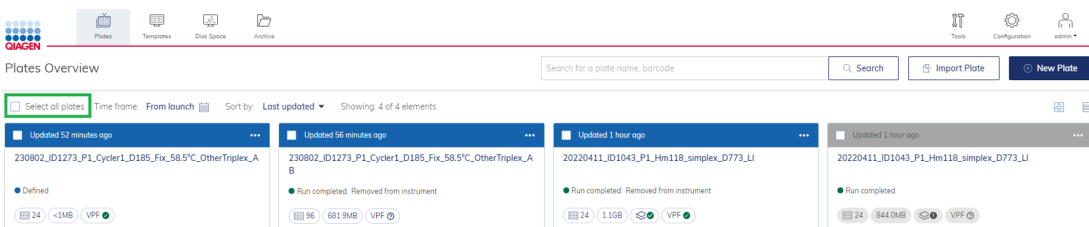

3. When all plates intended to be archived are selected, user should click **Actions** button and select **Archive** from drop-down menu:

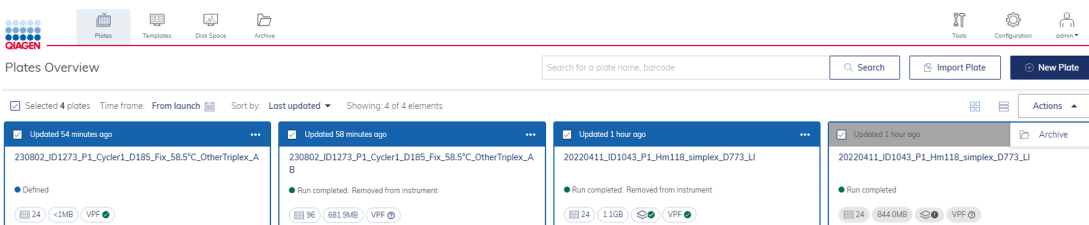

4. Archiving process should start as usually.

Note: Plates exhibiting the status Drafted and Running during upgrade and plates locked by instrument, cannot be archived and remain in Plate Overview.

7.8.4. Archive and recovering a plate from the archive

User can browse and search plates in the archive. Go to **Archive** on the navigation bar. User can then see all your archived plates.

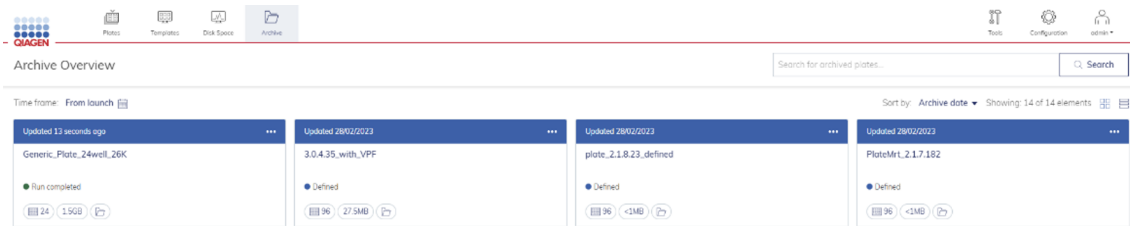

On plate tile there is option to check who (user login) archived the plate:

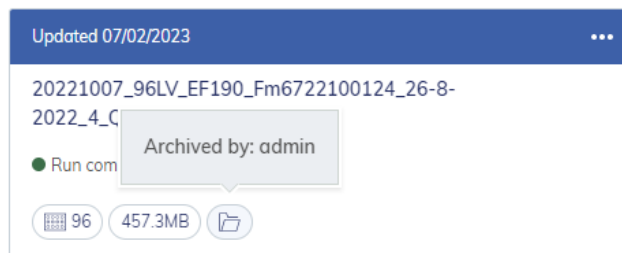

To restore plates from the archive, go to the Archive screen and click the three dots (...) on any of the plates on the Archive screen and select **Restore**. This operation can take a while depending on the plate size and speed of data transfer from the external drive.

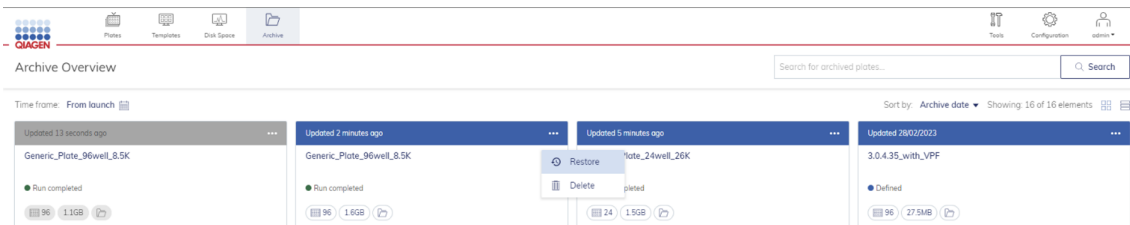

User should confirm the decision on the pop-up window, and restoring process will start, which will be indicated with blue pulse indicator:

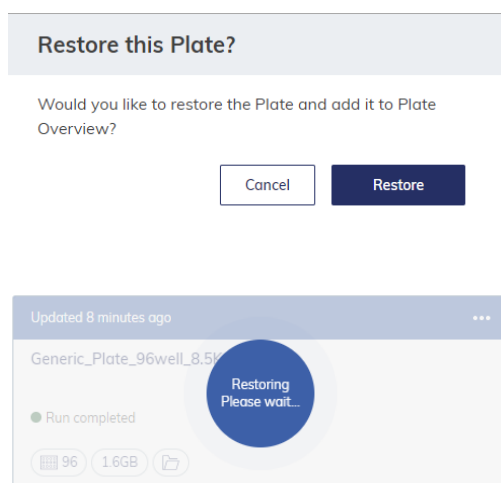

Note: All imported and restored, plates will automatically receive the VPF assignment, if a VPF is loaded in the system.

7.9. Audit trail

The Audit trail is a functionality in the QIAcuity Software Suite, which supports users meeting Good Manufacturing Practice (GMP)/Good Laboratory (GLP) regulations. The default setting of the QIAcuity Software Suite is the Audit trail tracker switched on. This functionality may be switched off by an Administrator if the QIAcuity systems are not operated in a GMP/GLP lab.

Important: The audit trail may only be switched off when GMP compliance is not required, for example, in molecular biology (MBA) labs. There is no data (events) stored and displayed when the tracker is turned OFF. In GMP environments, this toggle must not be set to OFF to maintain 21 CFR Part 11 compliance support.

When switched on, the Audit Trail records all actions that happened in the system. Each record consists of the following:

1. Time stamps: day, month, year, hour), minutes, second, and UTC Offset
2. User login that initiated the event that happened in the system
3. Category of the event (Instrument, Suite, or Plate)
4. Event type, what/who was affected by the action (Plate ID, User login, or Instrument ID)
5. Description of details after a change in table format

7.9.1. Audit trail tracker settings

1. To turn the Audit trail tracker ON/OFF, on the main toolbar, click the **Configuration** tab.



2. On the left-hand side, you can see the tabs menu. Click the **Audit Trail** tab. On the center of the page is the second tabs menu panel, click the **Audit trail tracker settings** tab.

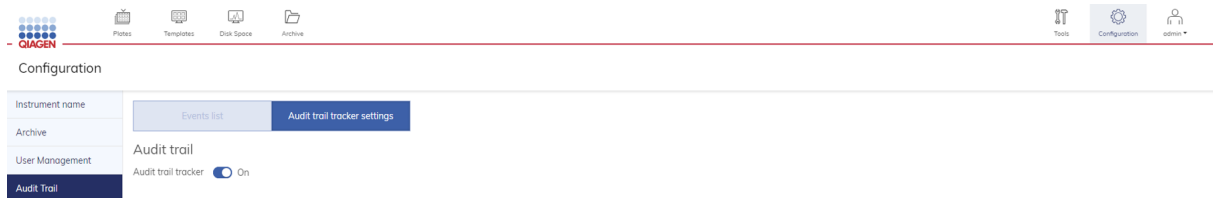

As shown below, the Audit trail tracker is turned off when the circle is at the left-hand side, the toggle is gray, and an “OFF” label appears at the right-hand side.

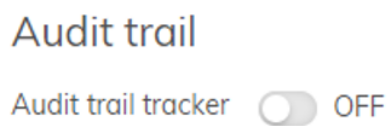

3. To turn the tracker ON, click the toggle.

When the Audit trail tracker is turned on, the circle is at the right-hand side, the toggle is blue, and an “ON” label appears at the right-hand side.

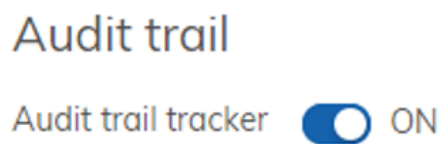

Moreover, there is additional indicator in the footer, bottom left corner of the application, informing about the selected option. If the Audit trail tracker is ON, the following indicator is displayed ON Audit trail enabled. Tracking activities. ; else if it is OFF, then

OFF Audit trail disabled. Not tracking activities. is displayed.

7.9.2. Events List

Events list table

The events list shows all events (logs) that happened in the system. There is no possibility to remove an event from the system by the User or Administrator.

To display the Events list, on the main toolbar, click the **Configuration** tab.

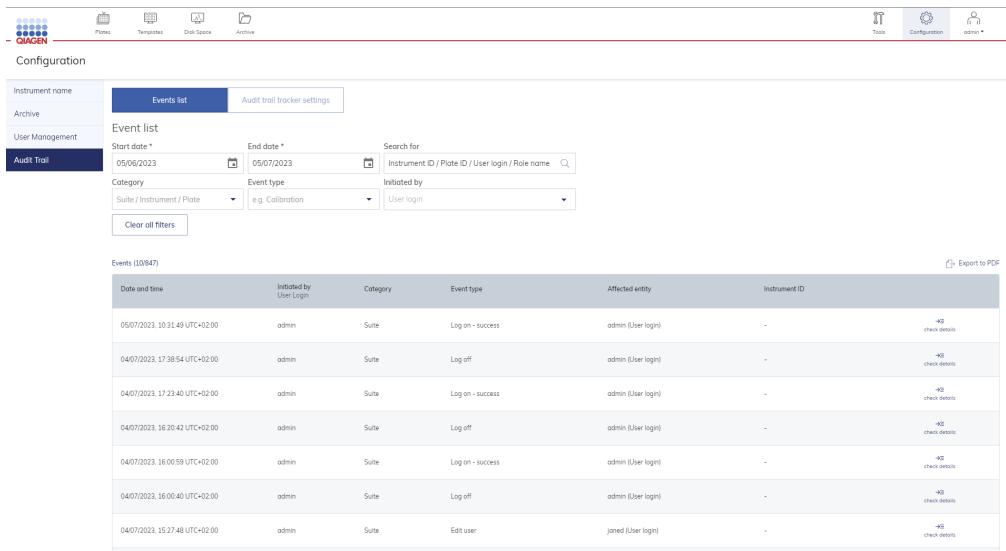

From the left-hand side menu, user can see the tabs menu. Click the **Audit Trail** tab. After clicking the **Audit Trail** tab, the following tab menu panel will appear. Click the **Events list** tab. Below the filters, user can find the Events list from the past months. The Events list is sorted chronologically, from the newest events to the oldest.

A screenshot of the 'Configuration' page. The left-hand side menu has 'Audit Trail' selected. The main area shows the 'Event list' tab. Below the tab are filters for 'Start date *' (05/06/2023), 'End date *' (05/07/2023), 'Search for' (Instrument ID / Plate ID / User login / Role name), 'Category' (Suite / Instrument / Plate), 'Event type' (e.g. Calibration), and 'Initiated by' (User login). There is a 'Clear all filters' button. Below the filters is a table of events.

Date and time	Initiated by	Category	Event type	Affected entity	Instrument ID	
05/07/2023, 10:31:49 UTC+02:00	admin	Suite	Log on - success	admin (User login)	-	⌵ check details
04/07/2023, 17:38:54 UTC+02:00	admin	Suite	Log off	admin (User login)	-	⌵ check details
04/07/2023, 17:23:40 UTC+02:00	admin	Suite	Log on - success	admin (User login)	-	⌵ check details
04/07/2023, 16:20:42 UTC+02:00	admin	Suite	Log off	admin (User login)	-	⌵ check details
04/07/2023, 16:00:59 UTC+02:00	admin	Suite	Log on - success	admin (User login)	-	⌵ check details
04/07/2023, 16:00:40 UTC+02:00	admin	Suite	Log off	admin (User login)	-	⌵ check details
04/07/2023, 15:27:48 UTC+02:00	admin	Suite	Edit user	janed (User login)	-	⌵ check details

To find a specific event, you can scroll the list down or use the following filters.

Start date *	End date *	Search for
<input type="text" value="05/06/2023"/>	<input type="text" value="05/07/2023"/>	<input type="text" value="Instrument ID / Plate ID / User login / Role name"/>
Category	Event type	Initiated by
<input type="text" value="Suite / Instrument / Plate"/>	<input type="text" value="e.g. Calibration"/>	<input type="text" value="User login"/>
<input type="button" value="Clear all filters"/>		

7.9.3. Search

Search for instrument ID, affected plate ID, user login, and role name

User can search for the instrument ID number, affected plate ID, affected user login, or affected role name. Click the search field: "Search for".

Search for

Input user's query. After a few seconds, the records on the events list will be updated automatically (example of Plate ID number: **b0bd01c1-0c6d-4377-b030-677f12711831**, example of instrument ID number: **QIAcuity-00617**).

7.9.4. Filters

Filter by specific date or specific time frame

To find all events that happened in one specific day or time period, user need to use the filters "Start date" and "End date".

Start date * End date *

07/07/2024 07/08/2024

Click the "Start date" input field or click the calendar icon.

Start date *

07/07/2024

Set the date that are you interested in from the calendar.

July 2024 < >

S	M	T	W	T	F	S
	1	2	3	4	5	6
7	8	9	10	11	12	13
14	15	16	17	18	19	20
21	22	23	24	25	26	27
28	29	30	31			

Then specify "End date" in similar manner.

Note: User can select the same day as in "Start date" to filter only a single, specific day. Afterwards, the records on events list will be updated automatically.

Filter: Category

User needs to use the “Category” filter to check all data related to one specific category (instrument, Suite, or Plate). Category refers to device/tool: instrument, Suite (PC Software), or Plate, on which the action has been taken.

1. **Instrument** – all events related to the instrument
2. **Suite** – all events that happened on the QIAcuity Software Suite (PC software)
3. **Plate** – all events related to Plates

Use the “Category” filter.

Category
Suite / Instrument / Plate

Click the drop-down arrow to view the three category options.

Category
Plate
Suite / Instrument / Plate
Instrument
Plate
Suite

Select only one option from drop-down list: Instrument, Plate, or Suite.

Category
Plate

Afterwards, the records list will be updated automatically.

The screenshot shows the QIAGEN software interface. At the top, there are navigation icons for Plates, Templates, Disk Source, and Archive. On the right, there are icons for Tools, Configuration, and a user profile labeled 'admin'. Below the navigation is a 'Configuration' section with a sidebar containing 'Instrument name', 'Archive', 'User Management', and 'Audit Trail' (which is selected). The main area shows the 'Event list' configuration with fields for 'Start date *' (07/07/2024), 'End date *' (07/08/2024), and 'Search for' (Instrument ID / Plate ID / User login / Role name). There are also dropdowns for 'Category' (Suite / Instrument / Plate) and 'Event type' (e.g. Calibration). A 'Clear all filters' button is present. Below the configuration is a table of events with columns: Date and time, Initiated by (User Login), Category, Event type, Affected entity, and Instrument ID. The table shows several log-on and log-off events. At the bottom left, there is a status indicator 'ON Audit trail enabled tracking activities'. At the bottom right, the version 'QIAcuity Software Suite 3.0.0.0' is displayed.

Date and time	Initiated by (User Login)	Category	Event type	Affected entity	Instrument ID
07/08/2024, 16:15:58 UTC+02:00	admin	Suite	Log on - success	admin (User login)	-
07/08/2024, 16:10:12 UTC+02:00	admin	Suite	Log off	admin (User login)	-
07/08/2024, 15:38:02 UTC+02:00	admin	Plate	Create template	078a880e-c1e1-4145-9157-1ec13bd967c1 (Plate ID)	-
07/08/2024, 15:37:20 UTC+02:00	admin	Suite	Log on - success	admin (User login)	-
07/08/2024, 15:37:16 UTC+02:00	admin	Suite	Log on - failure	admin (User login)	-
07/08/2024, 13:20:20 UTC+02:00	admin	Suite	Log off	admin (User login)	-
07/08/2024, 12:59:59 UTC+02:00	admin	Suite	Log on - success	admin (User login)	-
07/08/2024, 12:57:20 UTC+02:00	admin	Suite	Log off	admin (User login)	-

Filter: Event type

Event type refers to the action that happened in the system on the Instrument, Suite (PC software), or Plate. If user does not choose any option from the category, the filter displays a list of all event types (a sum of events type from all the three categories).

List of possible events: Plate experiment finish, User unlock plate, Archive plate, Restore plate, Import plate, Export plate, Support package download, Barcode removal, Instrument registration, Calibration, Plate schedule update, Experiment run (plate), Experiment canceled, Support package created, Update started, Drawer opening/closing during run, Clear error, Audit trail toggle, Archive configuration create, Archive configuration update, Archive configuration delete, Archive configuration schedule, Upload VPF, Apply VPF, Delete template, Update template, Create template, Create report, Delete report, Sign report, System version change, Create user, Edit user, Change password, User activation, User deactivation, Log on – success, Log on – failure, Log off, Automatic log off, Role creation, Role edition, Role deletion, Create plate, Update plate, Delete plate, Upgrade plate, Plate upgrade failed, Plate experiment change.

Note: The event type depends on the selected category. After filtering for a category, the event type list will only show event types related to the chosen category.

Use the “Event type” filter.

Event type

Click the arrow icon and choose one option from the drop-down list.

Event type

Afterwards, the records list will be updated automatically.

Plates Templates Disk Space Archive

The audit trail tracker has been turned ON.

Tools Configuration admin

Configuration

Instrument name

Archive

User Management

Audit Trail

Lab Automation

Events list Audit trail tracker settings

Event list

Start date * 04/11/2024 End date * 04/12/2024 Search for Instrument ID / Plate ID / User login / Role name

Category Suite / Instrument / Plate Event type e.g. Calibration Initiated by User login

Clear all filters

Events (10/33) Export to PDF

Date and time	Initiated by User Login	Category	Event type	Affected entity	Instrument ID	
04/12/2024 16:50:09 UTC+01:00	admin	Suite	Log on - success	admin (User login)	-	→E
04/12/2024 15:16:46 UTC+01:00	admin	Suite	Log off	admin (User login)	-	→E
04/12/2024 14:50:59 UTC+01:00	admin	Plate	Update plate	94e4b1cf-1c05-4410-b609-d4b4187c029a (Plate ID)	-	→E
04/12/2024 13:57:12 UTC+01:00	admin	Suite	Log on - success	admin (User login)	-	→E
04/12/2024 12:53:46 UTC+01:00	admin	Suite	Log off	admin (User login)	-	→E
04/12/2024 12:37:12 UTC+01:00	admin	Suite	Create user	jdoe (User login)	-	→E

ON Audit trail enabled. Tracking activities.

QIAcuity Software Suite 3.1.0.0

Filter: Initiated by

The filter "Initiated by" is related to a person (search for user login) that performed actions in the system. Login is unique and cannot be duplicated, so filtering for it will provide the user specific results.

Initiated by

admin user1

This filter allows you to even search for multiple users.

7.9.5. Check details

In the Events list, user can find the last option in the row, which is check details. Click it.

Configuration

Instrument name: **Events list** | Audit trail tracker settings

Archive

User Management

Audit Trail

Event list

Start date * 07/07/2024 | End date * 07/08/2024 | Search for Instrument ID / Plate ID / User login / Role name

Category Suite / Instrument / Plate | Event type Update plate | Initiated by User login

Clear all filters

Events (10/10) Export to PDF

Date and time	Initiated by User Login	Category	Event type	Affected entity Plate ID	Instrument ID	
05/08/2024, 08:52:03 UTC+02:00	admin	Plate	Update plate	e1e66f64-4811-4960-a912-796fa38e0701	-	→
31/07/2024, 14:27:37 UTC+02:00	admin	Plate	Update plate	e1e66f64-4811-4960-a912-796fa38e0701	-	→
31/07/2024, 14:37:18 UTC+02:00	admin	Plate	Update plate	e1e66f64-4811-4960-a912-796fa38e0701	-	→
31/07/2024, 14:26:49 UTC+02:00	admin	Plate	Update plate	e1e66f64-4811-4960-a912-796fa38e0701	-	→
30/07/2024, 15:50:14 UTC+02:00	admin	Plate	Update plate	17102051-0d09-4631-b528-6d3ce6a7b275	-	→
30/07/2024, 15:37:50 UTC+02:00	admin	Plate	Update plate	17102051-0d09-4631-b528-6d3ce6a7b275	-	→
19/07/2024, 12:42:29 UTC+02:00	admin	Plate	Update plate	38d93e05-6c66-4d31-8933-0b312a29f04	-	→
17/07/2024, 16:15:07 UTC+02:00	admin	Plate	Update plate	39d9e05-8021-4425-965e-3c126e0d8f1	-	→

ON Audit trail enabled. Tracking activities.

QIAcuity Software Suite 3.0.0.0

The check details option allows you to see all detailed changes that happened in the system. Changes are displayed as a table.

EVENT DETAILS

Plate experiment change

Event details

Date and time	Login	Event category	Event action	Affected entity Plate ID	Instrument ID
29/10/2024, 12:50:19 UTC+01:00	admin	Plate	Plate experiment change	1426e063-d86f-4525-ad7e-4ee0a07d900	-
wellPosition				25	
deleted					
lowCutoff				66.94	
disablePositiveCutoff				113.48	
highCutoff				86.06	
created					
lowerCutoff				86.06	
channel					
emission				GREEN	
excitation				GREEN	
dpaStepIndex				2	

Tracked differences in detailed audit trail events

For the following event types, the difference between existing and newly changed parameters (old to new value) is supported:

1. Update plate including, for example, threshold changes
2. Set plate ownership
3. Update template
4. Update template – reaction mix
5. Edit user
6. Edit role
7. Archive configuration update
8. Archive configuration schedule

To see the difference, go to the “check details” page of the given Audit Trail event. In section “modified”, there are two values presented in fields:

- From — contains information about the previous value.
- To — contains information about the new value that replaced the one listed in the “from” section.

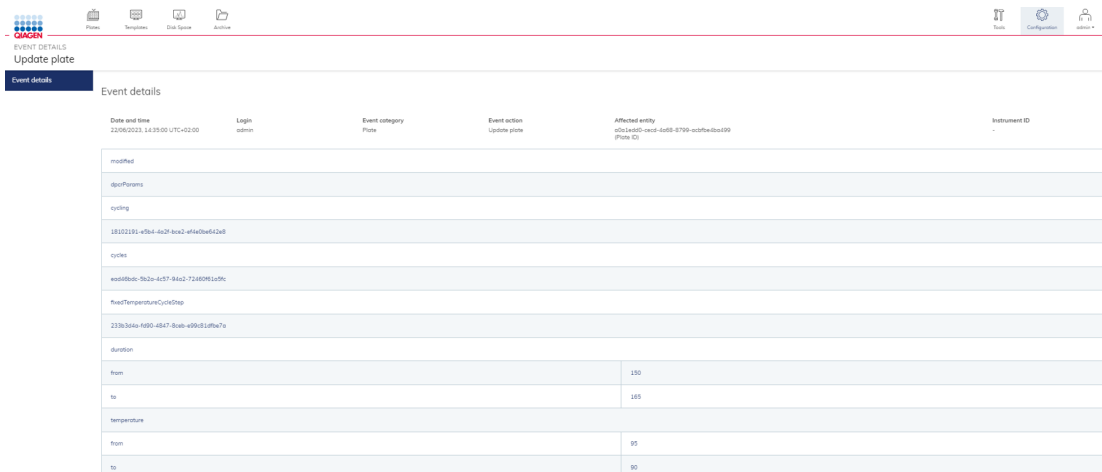

The screenshot shows the 'Event details' page for an 'Update plate' event. The page includes a navigation bar with icons for Home, Templates, Data Space, and Archive. The event details are as follows:

Date and time	Login	Event category	Event action	Attached entity	Instrument ID
23/06/2023 14:35:00 UTC+02:00	admin	Plate	Update plate	af21e450-7e6d-4d85-b799-cc3f8e3a1099 (Plate ID)	
modified					
dpcParams					
cycling					
18102131-v304-a42f-8a2f-ef4e3b6f32e8					
cycles					
e468866c-9d2a-4c37-91a2-72468961ca9c					
finalTemperatureCyclicStep					
233b364a-f890-4847-b94e-w99d319a7e7a					
duration					
from					
to					
temperature					
from					
to					

In case of deletions, there is a section called “deleted”, which contains all information that was previously available but was removed from the entity.

Update plate

Event details

Date and time	Login	Event category	Event action	Affected entity	Instrument ID
22/06/2023, 14:39:36 UTC+02:00	admin	Plate	Update plate	9011a400-cac2-4668-8799-0a3fba6a0499 [Plate ID]	-
deleted					
dpcParameters					
cycling					
18102191-a704-4c27-8a2c-af4e026af428					
cycles					
63425ef0-9e9b-4b84-8209-ba7188270963					
freeTemperatureCycleStep					
d7289c26-182b-4946-b66d-37428bc19c29					
duration	120				
temperature	60				
id	d7289c26-182b-4946-b66d-37428bc19c29				
position	0				
rampingSpeed	3.5				
count	1				
id	63425ef0-9e9b-4b84-8209-ba7188270963				
position	2				

[← Back to Events List](#)

7.9.6. AT part of plate

From QIAcuity Software Suite version 2.5 onwards, all dedicated plate-related audit trail events became part of the plate and are preserved during plate archiving and exporting. It means that plates originated from Software version 2.5 retain the previous history of all plate related audit trail events in a PDF file format. The dedicated PDF file is part of the details of the audit trail event Import plate.

Moreover, user can directly open all events related to particular plate from left-hand side panel in plate configurator with the option Plate Audit Trail.

Note: The Plate Audit Trail link of the plate configurator is only visible for logged in user exhibiting the permission for audit trail view.

PLATE CONFIGURATOR
Generic_Plate_24well_8.5K

- General Data
- dPCR parameters
- Reaction mixes
- Samples & controls
- Plate layout

- Analyze
- Reports
- Export
- Archive
- Support package
- Delete
- Plate Audit Trail

After clicking **Plate Audit Trail**, the screen automatically redirects to the audit trail environment and plate dedicated events are filtered by plate ID.

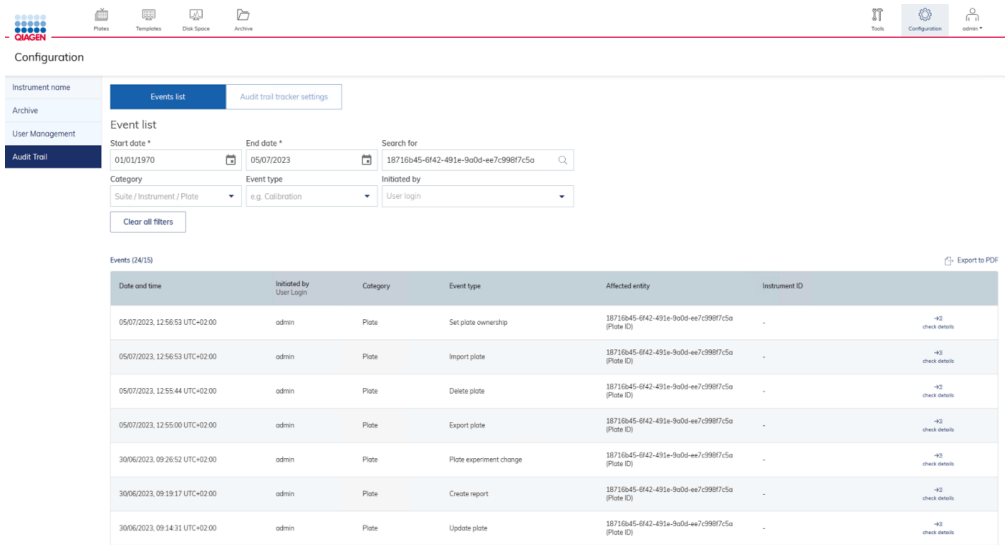

To check the plate-related audit trail events from a plate originated in another Software Suite instance, click **check details** in one of the following events: **Import plate** or **Restore plate**. Click **Imported Audit Trail** from left-hand side panel. Separate modal will be presented, from where PFD file with historical audit trail events can be downloaded:

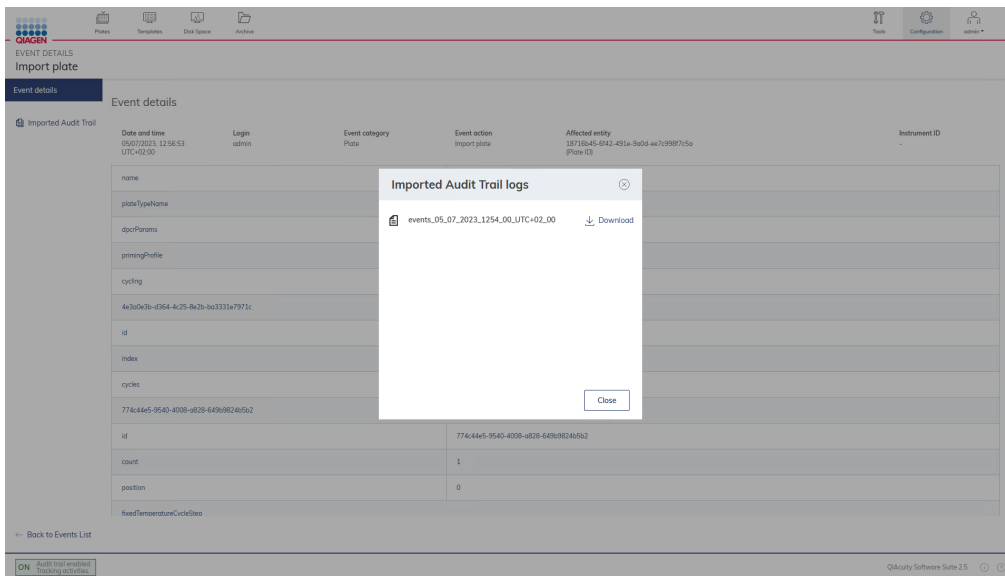

7.9.7. Exporting to PDF

All event details can be exported to a PDF file.

Note: Depending on the data throughput, the audit trail PDF export of all existing entries can take several minutes. Therefore, it is recommended to filter for the desired events first and then performing a PDF report export.

1. Click the Audit trail **Events list** tab.



2. Apply filters to select for those events that should be exported.
3. At the right-hand side, above the Event list, user can find the **Export to PDF** option. Click it.

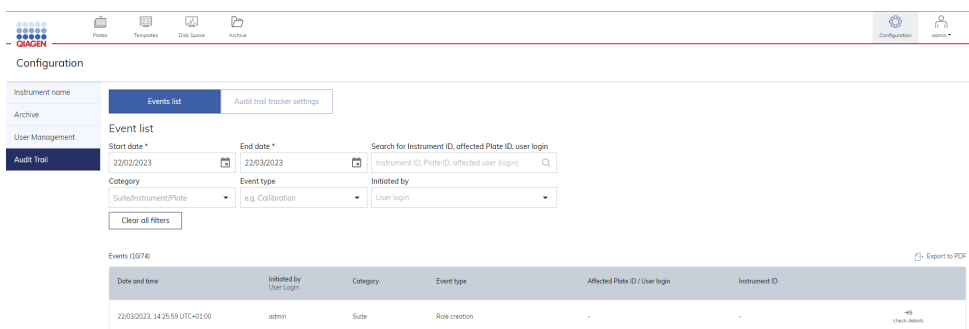

4. Depending on the audit trail data amount, a zip archive exhibiting PDF files will be downloaded. After 1000 audit trail elements, a separated PDF file will be created automatically. The audit trail export zip file name contains date and time of report generation. Each PDF file contains date and time of first and last event from this document.

7.10. General software use

7.10.1. Entering data

These shortcut functions are available in the QIAcuity Software Suite:

Table 17. Shortcut functions in QIAcuity Software Suite

Shortcut Function	Use
Ctrl + C	Copy
Ctrl + V	Paste
Tab and arrow keys	Navigate from one field to another

7.10.2. Displaying errors, warnings, and additional information

The QIAcuity Software Suite displays errors, warnings, and additional information messages throughout the experiment to prompt the user to perform a required action.

Table 18. Messages displayed in QIAcuity Software Suite

Priority level	Type	Color	Description	Required action from user
1	System error	Red	Combination of events requiring an action	User interaction required
2	Warning	Yellow	Situation could be optimized by further input	User interaction not required, but possible
3	Information	Gray	Message containing additional information about the current situation	No user interaction required

7.10.3. System error

In case of a system error, a red text box appears to describe the error and inform you of the required action. User must perform the required action described in the system error to proceed with the next step.

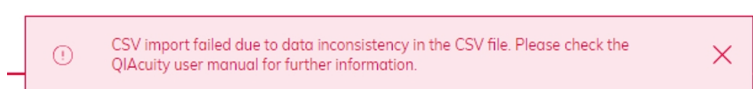

7.10.4. Warning message

A warning message is displayed in yellow in case further optimization of the experimental setup is recommended. A user interaction is not required to proceed with this step.

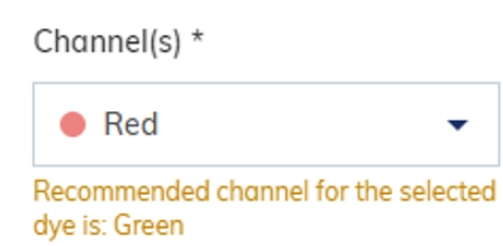

7.10.5. Information message

At certain fields in the experiment, user can view additional information regarding the required data to be entered on a field. Fields with information messages are marked with  icon. Clicking this icon displays a text box that provides additional information about the data needed in the field. No user interaction is required to proceed with this step.

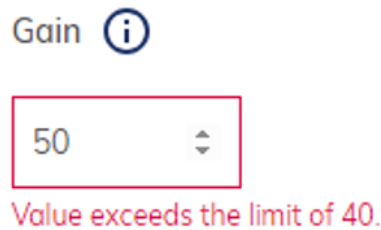

7.11. QIAcuity Lab Automation Service

Next to standard usage, the QIAcuity system offers extension called QIAcuity Lab Automation Service that allows third-party Lab Automation software to control a robot to interact with our system, run dPCR experiments, and analyze results without human interaction.

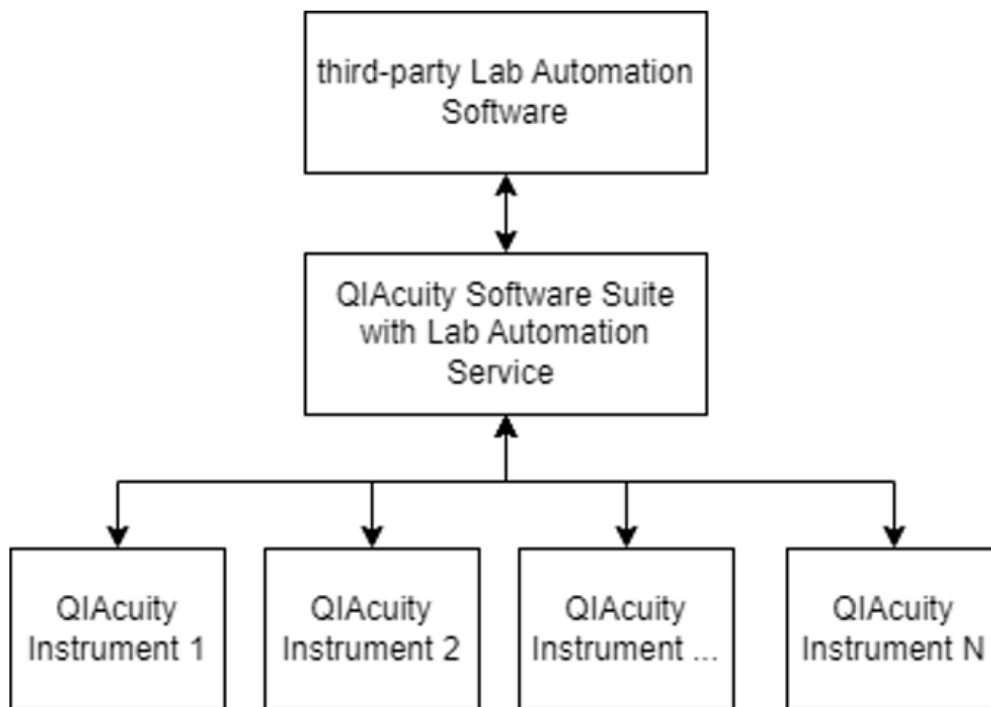

The QIAcuity Lab Automation Service is compatible to all QIAcuity systems, QIAcuity One, QIAcuity Four, and QIAcuity Eight, and several QIAcuity systems can be controlled in parallel.

For more guidance, please refer to *QIAcuity Lab Automation Service User Guide* (www.qiagen.com/HB-3537) available on QIAcuity webpage.

8. Maintenance Procedures

WARNING/ CAUTION

Risk of personal injury and material damage

Only perform maintenance that is specifically described in this user manual.



The following maintenance procedures must be carried out to ensure reliable operation of the QIAcuity:

1. Regular maintenance
2. Periodic maintenance

Optionally, these procedures may be performed to check and ensure the reliability of operation of the QIAcuity.

Select the cleaning agent according to the objective of the cleaning procedure, the sample material used, and the downstream assay.

WARNING

Risk of fire or explosion



When using ethanol or ethanol-based liquids on the QIAcuity, handle such liquids carefully and in accordance with the required safety regulations. If liquid has been spilled, wipe it off and allow flammable vapors to disperse.

Before using any cleaning or decontamination methods except those recommended by the manufacturer, users should check with the manufacturer that the proposed method will not damage the equipment.

8.1. Cleaning agents

The following disinfectants and detergents are recommended for cleaning the QIAcuity.

Note: To use disinfectants different from those recommended, ensure that their compositions are similar to those described below.

General cleaning of the QIAcuity

1. Mild Detergents (e.g., Mikrozyd[®] AF sensitive)
2. 25% ethanol

8.1.1. Disinfection

Ethanol-based disinfectants can be used for disinfection of surfaces (e.g., 25 g ethanol and 35 g 1-propanol per 100 g liquid or Mikrozyd Liquid (Schülke & Mayr GmbH, cat. no. 109160)).

Disinfectants based on glyoxal and quaternary ammonium salt can be used (e.g., 10 g glyoxal, 12 g lauryldimethylbenzylammonium chloride, 12 g myristyldimethylbenzylammonium chloride, and 5–15% nonionic detergent per 100 g liquid, Lysetol[®] AF [Gigasept Instru AF in Europe, cat. no. 107410, or DECON-QUAT[®] 100, Veltek Associates, Inc., in the USA, cat. no. DQ100-06-167-01]).

Removal of RNase contamination

RnaseZap[®] RNase Decontamination Solution (Ambion, Inc., cat. no. AM9780) can be used for cleaning surfaces. RnaseZap can also be used to perform decontamination by spraying the respective items.

Removal of nucleic acid contamination

DNA-ExitusPlus[™] (AppliChem, cat. no. A7089,0100) can be used for cleaning surfaces. DNA-ExitusPlus can also be used to perform decontamination by spraying the respective items. DNA-ExitusPlus is very sticky and foamy. For this reason, after cleaning the items with DNA-ExitusPlus, user must clean the items with a wet cloth several times, or rinse them with running water, until the DNA-ExitusPlus is completely removed.

General instructions

1. Do not use spray bottles to spray cleaning or disinfectant liquids onto surfaces of the QIAcuity.
2. If solvents or saline, acidic, or alkaline solutions are spilled on the QIAcuity, wipe the spilled liquid away immediately.
3. Follow the manufacturer's safety instruction for handling cleaning agents.
4. Follow the manufacturer's instruction for soaking time and concentration of the cleaning agents.

Important: Immersing for longer than the recommended soak time can harm the instrument.

Note: Disinfection reagents shall be distributed equally on the instrument surface and drops shall be avoided.

5. Ensure that no liquid runs down the touchscreen. Liquid may be drawn through the dust protection sealing by capillary forces and cause malfunction of the display. To clean the touchscreen, moisten a soft lint-free cloth with water, ethanol, or a mild detergent and carefully wipe the display. Wipe dry with a paper towel.

CAUTION Damage to the instrument



Do not use bleach, solvents, or reagents containing acids, alkalis, or abrasives to clean the QIAcuity.

CAUTION Damage to the instrument



Do not use spray bottles containing alcohol or disinfectant to clean surfaces of the QIAcuity. Take special care while cleaning the extended drawer that no liquid is spilled into the inside of the instrument.

WARNING Risk of fire



Do not allow cleaning fluid or decontamination agents to come into contact with the electrical parts of the QIAcuity. Take special care while cleaning the extended drawer that no liquid is spilled into the inside of the instrument.

WARNING Risk of electric shock



Do not open any panels on the QIAcuity.

Risk of personal injury and material damage

Only perform maintenance that is specifically described in this user manual. Any other maintenance or repair may only be carried out by an authorized Field Service Specialist.

WARNING Hazardous chemicals and infectious agents



The plates may contain hazardous material and must be disposed of properly. Refer to your local safety regulations for proper disposal procedures.

WARNING/CAUTION Risk of personal injury and material damage



Improper use of the QIAcuity may cause personal injuries or damage to the instrument. The QIAcuity must only be operated by qualified personnel who have been appropriately trained. Servicing of the QIAcuity must only be performed by a QIAGEN field service specialist.

WARNING Risk of explosion



When cleaning the QIAcuity with alcohol-based disinfectant, allow flammable vapors to disperse.

WARNING Risk of fire or explosion



When using ethanol or ethanol-based liquids on the QIAcuity, handle such liquids carefully and in accordance with the required safety regulations. If liquid has been spilled, wipe it off and allow flammable vapors to disperse.

WARNING Toxic fumes



Do not use bleach to clean or disinfect the QIAcuity.

WARNING Toxic fumes



Do not use bleach to disinfect used labware.

8.2. Servicing

Contact QIAGEN Technical Services or your local distributor for more information about flexible Service Support Agreements from QIAGEN.

WARNING/CAUTION Risk of personal injury and material damage



Improper use of the QIAcuity may cause personal injuries or damage to the instrument. The QIAcuity must only be operated by qualified personnel who have been appropriately trained. Servicing of the QIAcuity must only be performed by a QIAGEN field service specialist.

8.3. Regular maintenance procedure of QIAcuity

Clean the instrument on a regular basis, especially if fluids have been spilled on the instrument. See "Cleaning agents" for the recommended cleaning agents that can be used to clean the QIAcuity instrument. All outer surfaces of the instrument, including the touch display, and the extended drawer can be cleaned.

8.4. Periodic maintenance

8.4.1. Air filter change

We recommend changing the air inlet filter of the instrument once per year. This will be part of an annual scheduled service visit. When operating the instrument in unusual dusty environments, a more frequent filter change might be necessary.

Note: Air filters can be ordered separately. See Ordering information for more information.

Follow these steps for changing the air filter:

1. Turn off instrument and remove power cord.
2. Reach under the front of the instrument and push both buttons simultaneously.



3. Remove the filter from the swing-out filter compartment.

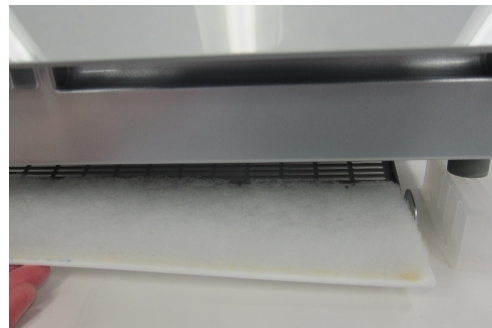
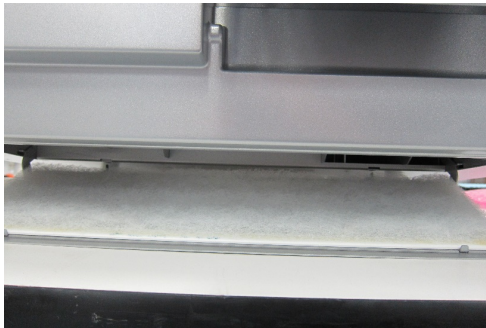

4. Replace with a new filter and push the compartment to the top to close.

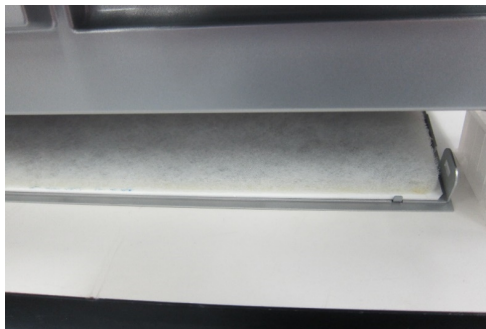

8.4.2. Calibration of thermal cycler

The thermal cycler is designed to operate with the same specifications over the lifetime of the instrument. The cyclers are factory calibrated in production and the specification is controlled as part of the final instrument QC. This is part of the provided certificate of manufacture, where the SN of the calibrated module is referenced, and the passed calibration and temperature accuracy is checked. To ensure and verify the quality of the cycler, the calibration of the thermal cycler is part of an annual scheduled service visit.

8.5. Decontaminating the QIAcuity

If the QIAcuity is contaminated with infectious material, it should be decontaminated. If hazardous material is spilled on the outer surfaces or the plate trays of the QIAcuity, the user is responsible for carrying out appropriate decontamination. If damaged plates were used and the inside of the instrument is contaminated, contact QIAGEN Technical Services.

The QIAcuity should also be decontaminated before shipping (e.g., back to QIAcuity). In this case, a decontamination certificate must be completed to confirm that the decontamination procedure has been carried out.

To decontaminate the QIAcuity, follow the procedure in section Disinfection, using the recommended disinfection agents.

8.6. Regular maintenance procedure for QIAcuity instrument software

The QIAcuity stores various information about the runs and plates used in the instrument. Images created during the runs are deleted automatically after they are transferred to the QIAcuity Software Suite. If the instrument is not connected to the Software Suite, the data are cached on the local storage until a connection to the Software Suite is established. Other plate information is saved on the local storage of the device as temporary data.

8.6.1. Deleting temporary data

You can remove temporary data from the instrument to save space on the local storage or to clear some space on the disk when the disk space becomes full. The current state of available storage is shown in the Storage Info pane and the below **Disk Monitor** icon (once clicked).

When the disk space is running low, a notification is shown to all users. Operators do not have permission to delete the temporary files, and they are instructed to contact their administrator.

1. Tap the **Tools**  icon.
2. Tap **Data Management**.

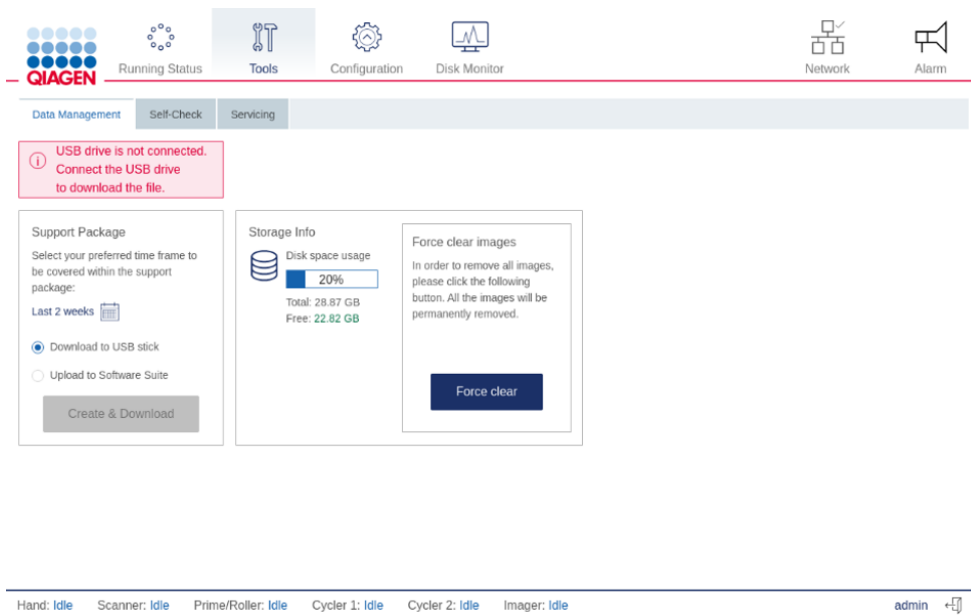

3. To clear the data, tap **Force clear images**. Click **OK** in the confirmation dialog box to delete the data. Images from the system and database will be removed.

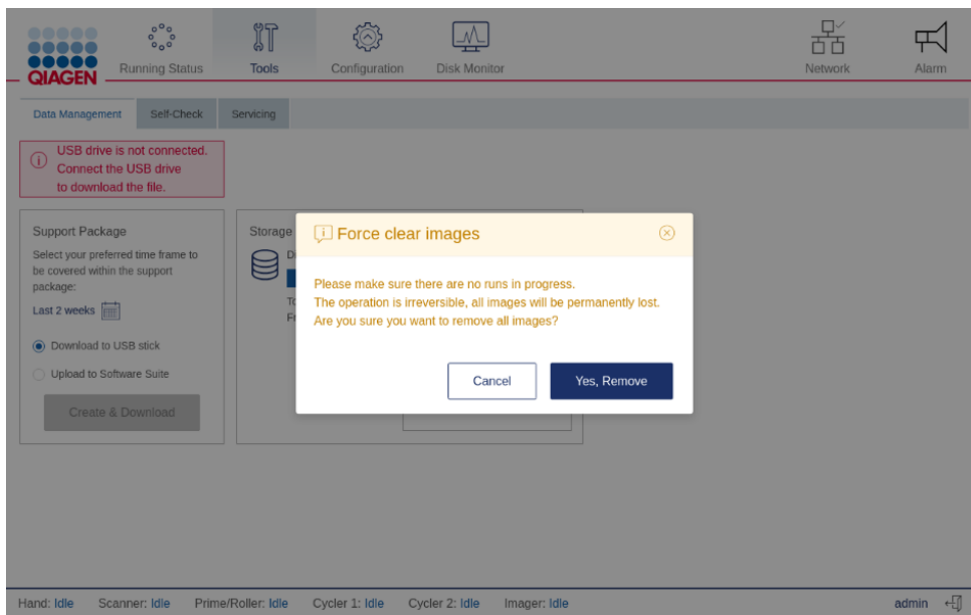

8.7. Regular maintenance procedure for QIAcuity Software Suite

To monitor the space of your disk, click **Disk monitor** in the main toolbar. This shows an overview about the state of the disk, disk name, and disk path. It also shows the remaining free space and total space of your disk.

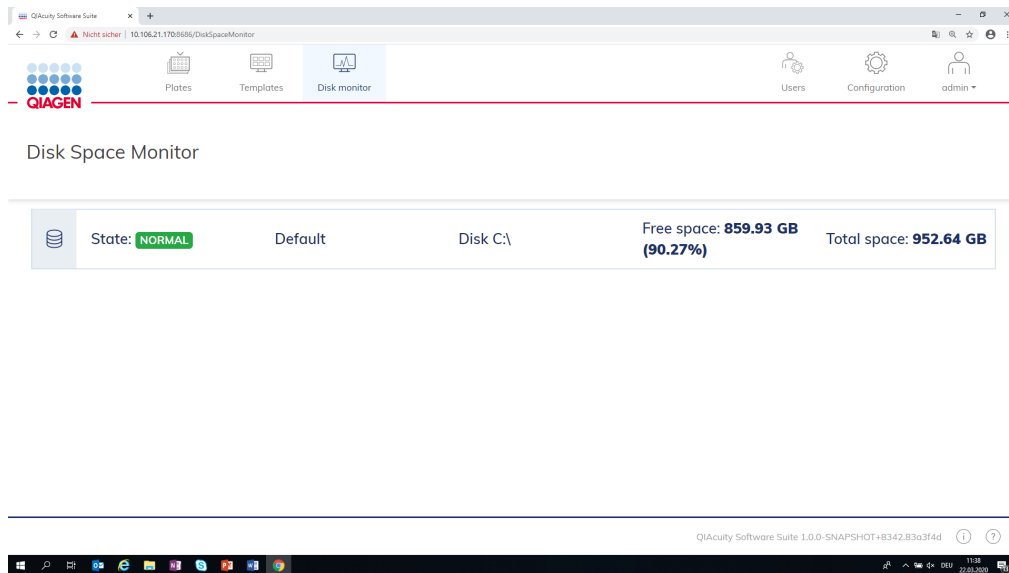

Disk monitor overview.

There are four different disk states possible regarding the availability of free space.

Table 19. Disk status

State	Meaning	Flag
Normal	No threshold has been reached.	None
Warning	Disk space reached the warning level, there is only disk space for a few runs left.	Yellow dot in disk monitor icon
Critical	No disk space left to store more run data.	Red dot in disk monitor icon
Unavailable	The disk is not available.	None

To free up disk space, user can export and delete used plates. See "Managing your plates" for more information about exporting and deleting plates.

Note: It is recommended to check the free disk space on a regular manner and to archive or delete data appropriately.

9. Troubleshooting

9.1. General information

This section provides information about what to do if an error occurs while using the QIAcuity.

9.2. Contacting QIAGEN Technical Services

Whenever a QIAcuity error is encountered, ensure to have the following information at hand:

1. Software version
2. Sample input material
3. Detailed description of the error situation
4. Serial number of the instrument

This information will help you and your QIAGEN Technical Service Specialist to deal most efficiently with your issue.

Note: For most cases, to allow proper analysis of an error situation, the support package either from the instrument and/or the Software Suite is required. Refer to “Creating a support package with the QIAcuity instrument software”.

Note: Information about the latest software and protocol versions can be found at www.qiagen.com/MyQIAcuity. In some cases, updates may be available for addressing specific problems.

9.3. Performing a self-check on the QIAcuity instrument

The QIAcuity software can perform a self-check of the instrument to check the state of the device. There are two types of self-checks:

1. **Quick test:** This test does not include any hardware movement
2. **Extended test:** This test includes hardware movement. All modules return to their initial positions. If a plate is detected in the gripper, the plate is returned to the drawer.

To start a self-check, follow these steps:

1. Tap **Tools** .
2. Tap **Self-check**.
3. Tap **Quick Test** or **Extended Test** depending on the type of test you want to perform.
4. The instrument starts the test. The ongoing actions and their statuses are shown in the Log File Preview pane. The log from the test can be downloaded as part of a support package. For more information about support package, see "Creating a support package with the QIAcuity instrument software".

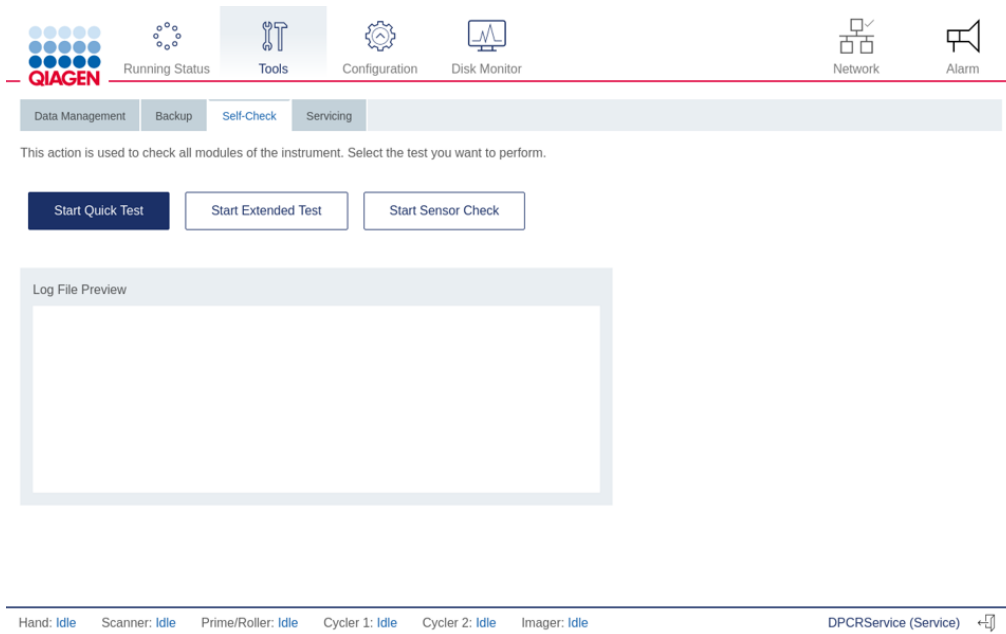



9.4. Creating a support package with the QIAcuity instrument software

User can create a support package in case of an error. The support package can be uploaded to the Software Suite or saved to a USB drive.

To create a support package and upload it to the Software Suite, follow the steps below. The QIAcuity Software Suite will combine the support package from the instrument and the Software Suite.

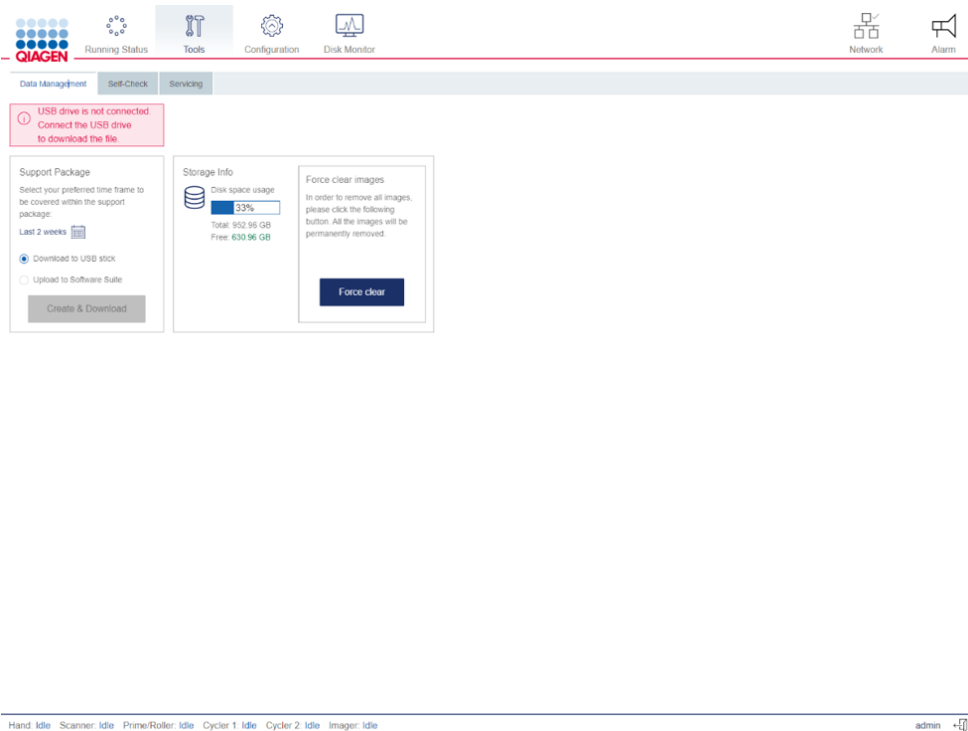
1. On the toolbar, tap **Tools**.
2. Tap **Data Management**.



3. In the Support package pane, select **Upload to Software Suite**.
4. To set the timeframe of the support package, tap **Set timeframe** . The default timeframe is the last two weeks.
5. Tap the applicable option for your preferred timeframe.
 - a. Tap **Today** to create a support package for the current day.
 - b. Tap **Last week** or **Last 2 weeks** to select either the last week or the last 2 weeks.
 - c. To set a custom timeframe, tap **From** and select a start date from the calendar. Then, tap **To** and select an end date from the calendar.

6. Tap **Apply** to save the changes.

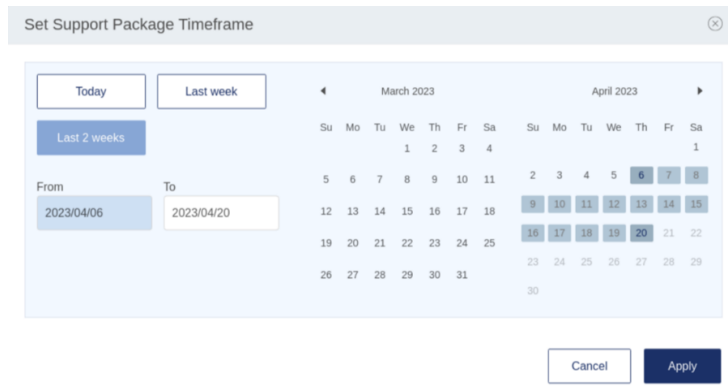

Set Support Package Timeframe dialog box.

7. Tap **Create & Download**.

8. A progress bar is shown. To cancel the download, tap the progress bar. Once the download is complete, a notification is displayed.

To create a support package and save it on a USB drive, follow the steps below.

1. On the toolbar, tap **Tools** .
2. Tap **Data Management**.

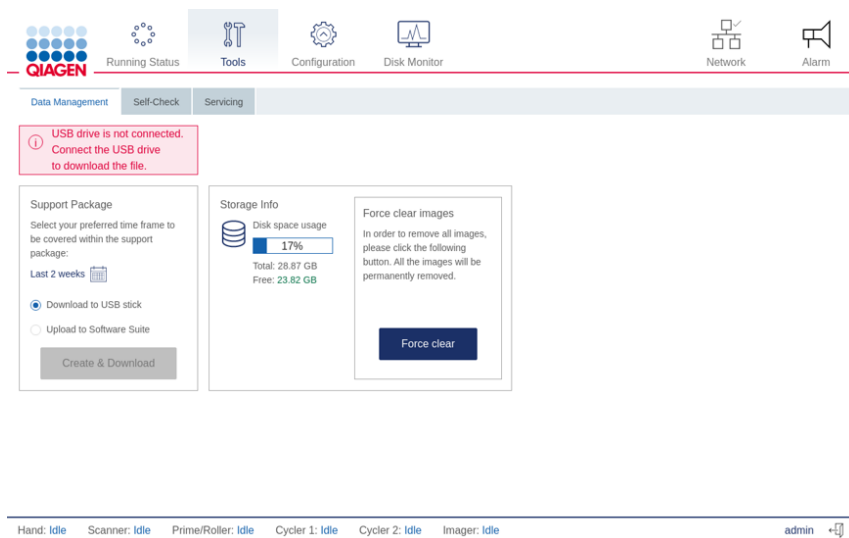

- Connect a USB drive to the instrument. Wait for the device to detect the USB drive. A notification is displayed once the drive is connected.

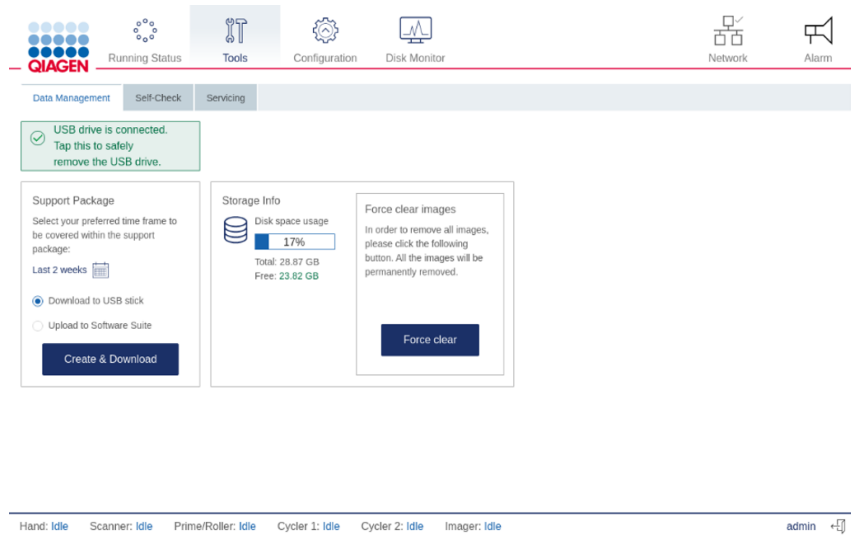

- In the Support Package pane, select **Download to USB drive**.
- To set the timeframe of the support package, tap **Set timeframe** . The default timeframe is the last two weeks.
- Tap the applicable option for your preferred timeframe.
 - Tap **Today** to create a support package for the current day.
 - Tap **Last week** or **Last 2 weeks** to select either the past week or the past two weeks.
 - To set a custom timeframe, tap **From** and select a start date from the calendar. Then, tap **To** and select an end date from the calendar.
- Tap **Apply** to save the changes.

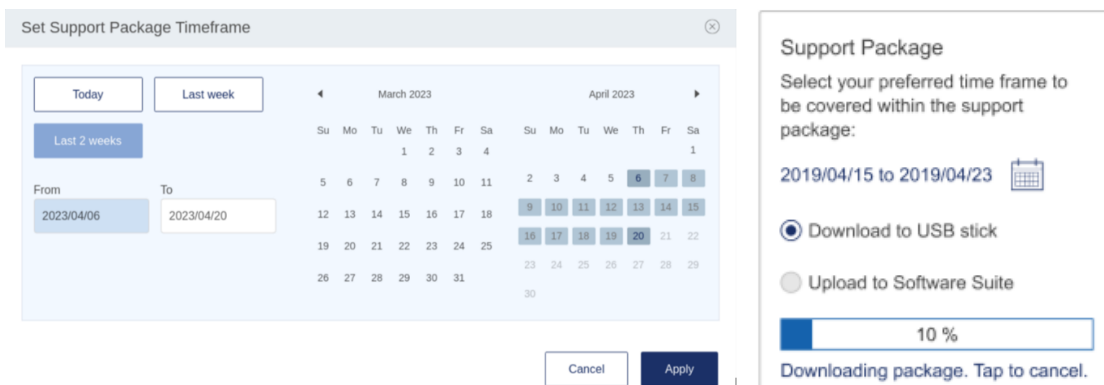

- Tap **Create download**.
- A progress bar is shown. To cancel the download, tap the progress bar. Once the download is complete, a notification is displayed, and the USB drive can be removed from the instrument.

9.5. Software support package

Since version 2.5, QIAcuity Software Suite offers possibility to automatically generate software support package that can automatically collect required logs from Software Suite and instrument as well.

Software support package can be generated in following scenarios:

1. Problem with running Software Suite
2. Problem at logging screen
3. Problem during Software Suite runtime

9.5.1. Problem with starting the Software Suite

When there is a problem with starting the Software Suite, for example, directly after upgrade application cannot start-up correctly, special fallback page is presented instead of regular login screen:

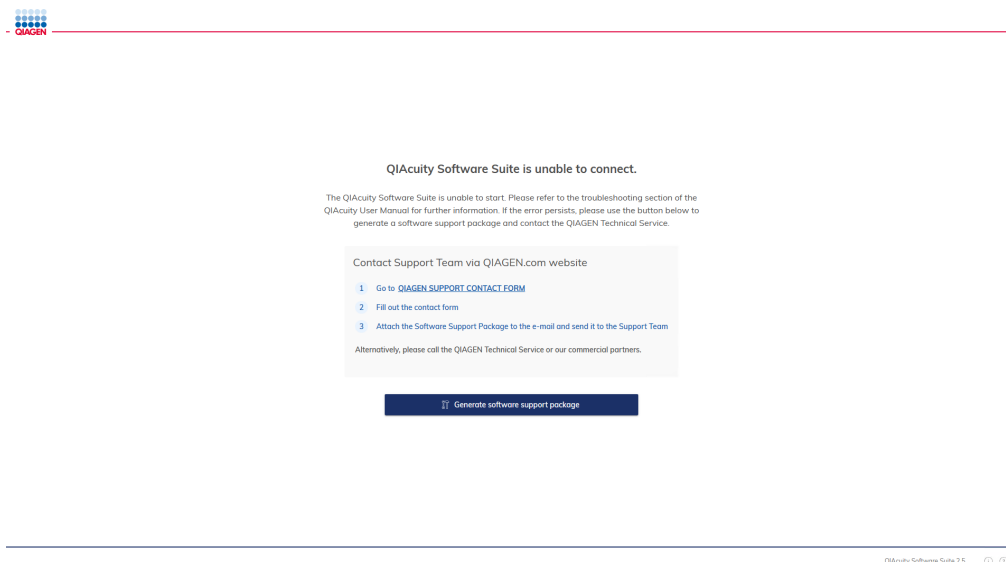

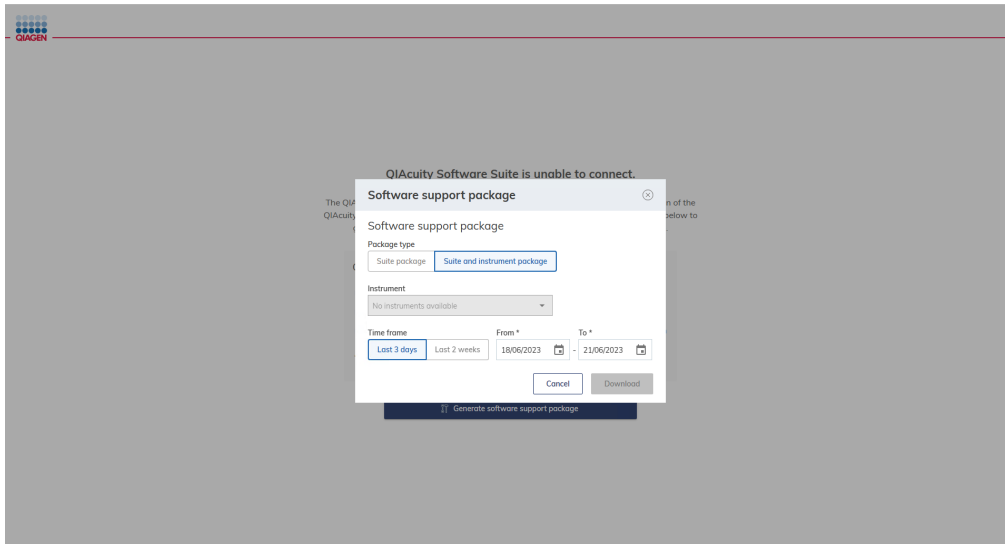

1. On the above window, user should select package type:
 - a. Software Suite package — all available logs for the Software Suite will be automatically collected
 - b. Software Suite and instrument — all available logs for the Software Suite and logs for connected instrument will be automatically collected:
 - **Note:** User needs to trigger collecting and sending logs to the Software Suite on instrument first according following screenshot:

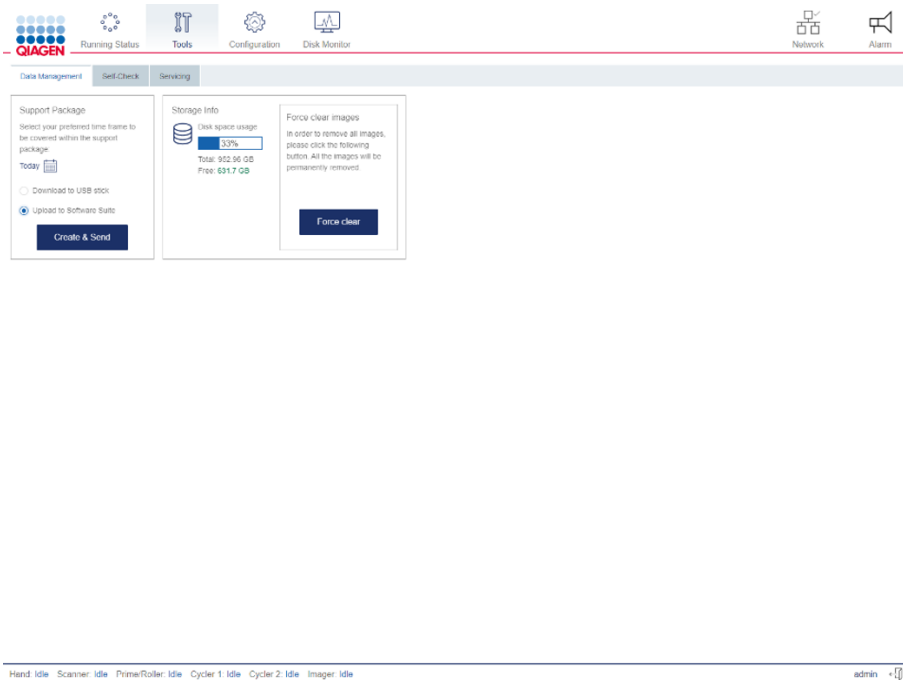

- User needs to point the instrument from which logs should be collected by selecting it from instrument drop-down list shown on window below:

Software support package

Package type

Suite package Suite and instrument package

Instrument

NewInstrument

NewInstrument

Last 3 days Last 2 WEEKS 23/09/2023 - 26/09/2023

Download

Close

2. User needs to select appropriate time period using one of:
 - a. **Time frame** buttons
 - b. **From/To** selectors
3. Finally user has to click **Download** button.

9.5.2. Problem at logging screen

On the application login screen, when there is a problem with logging in, for example, user's credentials are fine but user still cannot login, user should click **Cannot log in?** next to Login button. After clicking, similar window, as described in section 9.5.1, Problem with starting the Software Suite, will appear. Also here, user needs to select package type, specific instrument (if the Software Suite and instrument package has been selected) and time period to collect the logs. Finally user has to click **Download** button to generate the package.

Cannot log in? ⊗

Contact Support Team via QIAGEN.com website

- 1 Go to [QIAGEN SUPPORT CONTACT FORM](#)
- 2 Fill out the contact form
- 3 Attach the Software Support Package to the e-mail and send it to the Support Team

Alternatively, please call the QIAGEN Technical Service or our commercial partners.

Software support package

Package type

Suite package Suite and instrument package

Download

Close

9.5.3. Problem during the Software Suite runtime

When there is a problem during application runtime, user can navigate to **Tools** on top bar and then click **Generate software support package** button from **Troubleshooting** menu:

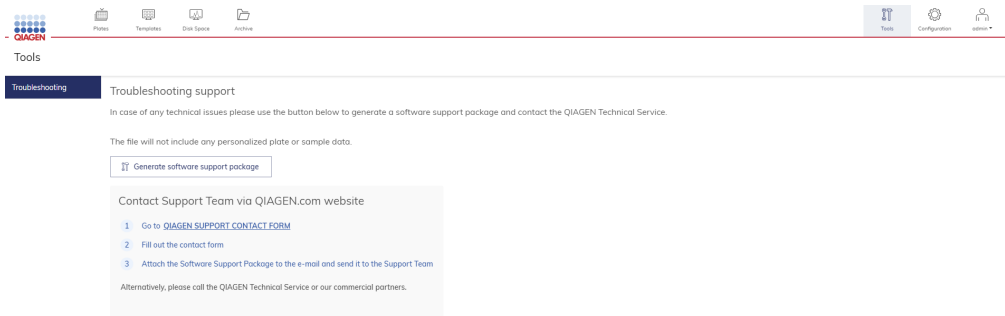

After clicking the above button, a similar window as described in previous sections will be presented and user needs to follow the same procedure.

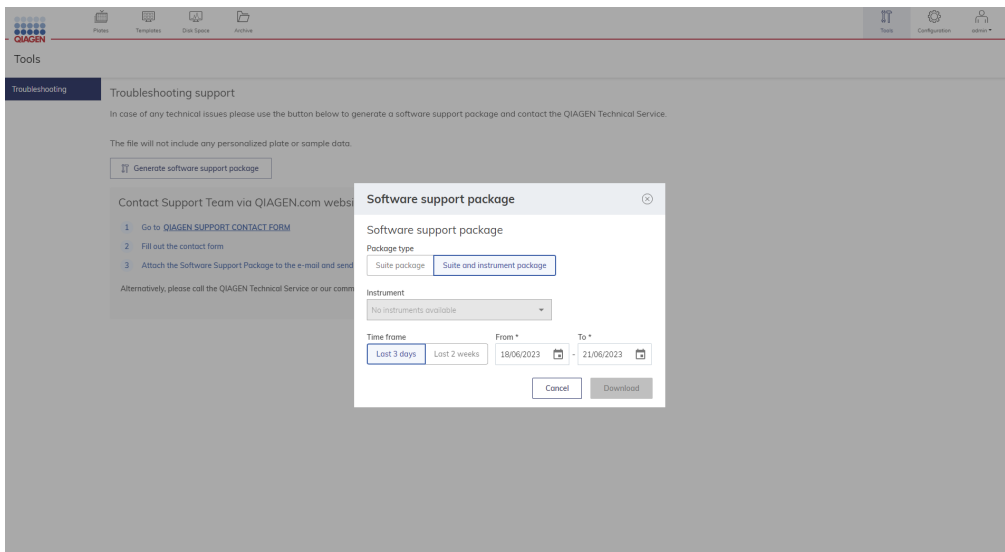

9.6. Creating a support package with the QIAcuity Software Suite

1. Select a plate in the plates overview.
2. Click the left side of the screen on the Support Package.

A new window pops up, where user can specify what kind of support package needs to be generated and from which time frame.

PLATE CONFIGURATOR
Generic_Plate_96well_8.5K - Upgraded

General Data

dPCR parameters

Reaction mixes

Samples & controls

Plate layout

Analyze

Reports

Export

Support package

Delete

General Data

The volume of this nanoplate is not yet optimized. You can work with these results, however, in order to get the most accurate results, please click the Upload VPF button and follow the instruction. [Upload VPF](#)

Plate name * Characters left: 64
Generic_Plate_96well_8.5K - Upgraded

Plate type
Nanoplate 8.5K 96-well

Description Characters left: 2000

Labels Labels left: 10
Confirm each label with 'Enter' button

Plate Ownership *
admin admin (admin) add user
Type user name, surname or login to add user

Barcode
You may scan it using USB scanner, enter it now or scan it later, by the instrument [Scan](#)

Plates

Templates

Disk Space

Archive

SUPPORT PACKAGE
Demo run

Support package details

Please select package details:

standard package
combined images and logs

extended package
raw images and logs (> 20 MB)

Select date range 20/04/2023 - 20/04/2023

[Download](#)

Note: The standard package includes the log files and a combined image view of all wells. The extended package includes the log files and the raw images of each single well. By clicking the calendar symbol, user can define the time frame from which the support package shall be generated. Click **Download** to download the support package as zip file.

9.7. Troubleshooting the instrument and software

Comments and suggestions

Installation and maintenance	
1. Instrument does not power on	Check if the power outlet is working properly and the correct voltage is applied. Check the correct connection of the power cable between power outlet and instrument power inlet. If the instrument fuses are blown, contact QIAGEN Technical Services.
2. Handler blocked	If the hand cannot move freely during initialization of the instrument, check if the transport locking screw was removed according to the installation procedure.
3. Overheating	If an overheating error is shown or the instrument shuts off during an operation, ensure correct ventilation of the instrument and correct environmental conditions according the installation section requirements. Ensure that the air filter is not clogged and exchanged on a regular basis.
Plate loading	
1. Plate presence/orientation	The instrument detects the proper orientation of the plate. Ensure that the barcode is pointed to the instrument back and the microstructures to the bottom.
2. Plate Seal presence	A missing Plate Seal is detected by the instrument. Ensure that always a closed plate with Plate Seal is loaded into the instrument. A run cannot be started if a plate seal is not detected by the instrument. Only use QIAGEN products for closing the plates.
3. Drawer blocking	If the drawer is retrieved and blocked, ensure that the plate is correctly loaded into the drawer and parallel to the base surface of the drawer.
4. Plate retrieving	If a plate could not be retrieved correctly in the instrument, ensure that the Plate Seal is applied properly and not overlapping more than 1 mm at the plate side surfaces. Check for any typographical error in the plate barcode of the experiment in the QIAcuity Software Suite.
5. Run cannot start	Check if the QIAcuity Software Suite is online.
Mechanical	
Frame of instrument is distorted (e.g., uneven, unstable or not level)	Ensure that the instrument is placed on a stable, flat and level surface as described in Installing the QIAcuity.
Electronic	
1. Display does not turn on	Do not touch the display with excessive force or use corrosive chemicals to clean the display surface. Contact QIAGEN Technical Services for repair.
2. Error when copying files to USB	Power OFF the QIAcuity, wait for a few minutes, and power it ON again. Save the file(s) to the USB stick again. Check the USB stick on a PC to ensure it is functional. If the error persists, contact QIAGEN Technical Services.
3. USB device not detected	Power OFF the QIAcuity, wait for a few minutes, and power it ON again. Insert the USB stick into the USB port. Check the USB stick on a PC to ensure it is functional. If the error persists, contact QIAGEN Technical Services.
4. Login screen not visible when starting instrument	If the touchscreen does not display the login screen, but instead a software update message is shown, power OFF the QIAcuity and wait for a few minutes. Ensure that the USB stick is not inserted in the USB port. Power ON the QIAcuity again. The login screen should be visible. If the error persists, contact QIAGEN Technical Services.
5. Starting of instrument takes long	After Update of the instrument software the Firmware Update might be run in the background causing a long starting period (up to 60 min).
Application	
1. Images or analysis data cannot be viewed	Check the connection to the QIAcuity instrument. Check if the correct protocols and reagents have been used. Check if the reaction was set up correctly.
2. Poor or no amplification	Check the cycling and imaging conditions. Check if correct restriction enzyme was used when using gDNA as template material. Check the starting quality and quantity of the template. We recommend that you use QIAGEN kits for sample preparation.

Comments and suggestions

	Check if the correct protocols and reagents have been used.
3. No clear separation between positive and negative partitions	Check if the reaction was set up correctly. Check the cycling and imaging conditions. Check if correct restriction enzyme was used when using gDNA as template material. Check the starting quality and quantity of the template. We recommend that you use QIAGEN kits for sample preparation.
4. Images are saturated	Re-image the plate with 30% lower exposure duration (see also section Image quality control)
5. Sample result is 0 copies/ μ L or infinite in absolute quantification	If your concentration is 0 copies/ μ L, although the sample is not an NTC, check the Histogram or 1D Scatterplot for this well. In case of having nearly only positive partitions in the well, a proper auto-threshold setting was likely not possible. Check also if the image of the well is too dark, and in case re-image the plate with 30% higher exposure time or gain settings.
6. Sample results of replicates differ a lot	Check the images for blacked-out areas, that can occur, e.g., due to bad filling or areas of low amplification (see section Image corrective measures)
7. High copy number in NTC	Check the images or signal map for dust or other particles. In case, wipe the plate with a lint-free tissue (optionally, use ethanol) and re-image the plate.
8. Lower RFU of negative partitions in NTC/samples with low number of positive partitions	The signal intensity might be lower in images with high number of negative partitions. There is no influence on the result analysis, as the signal to noise is not affected.
9. The confidence interval is wide	The number of valid partitions is low. Check the images for blacked-out areas, that can occur, e.g., due to bad filling or areas of low amplification (see section "Image corrective measures")
10. Vertical stripes in the images	Re-image the plate for proper image analysis
11. Double positive or double negative signals	The double positive or double negative signals could have different root causes. One of the reasons for observing double signal bands could be suboptimal assay designs, such as cross-hybridization of probes to unspecific targets or secondary off-target amplification products. Besides assays-related causes, improper cross talk compensation could also be the root cause. An insufficient compensation or overcompensation of cross talk from neighboring channels could also result in extra signal bands. To determine the main root cause, re-image the plate with 30% less exposure times for affected channel. If double bands disappear or get much closer to each other after re-imaging, they are most likely to be caused by improper cross talk compensation rather than assay-related issues.
12. Fetch error while accessing the Users list in User Management	If such error occurs, contact QIAGEN Technical Service to solve the issue.

Software

1. The QIAcuity Software Suite does not start	Check that the software is installed on the laptop. Check the operating system. The QIAcuity Software Suite can only be operated on Windows 10.
2. Installation of QIAcuity Software Suite failed	Check the firewall settings on Windows and router to make sure that the following ports: 8080, 8687, 9595, 44321 are available and opened in the network.
3. User cannot create new plate after rollback	During rollback Suite should be closed – if user forgot to close it then relog after rollback is needed
4. Disc space is critical in the QIAcuity Software Suite	Delete plates from the plates overview.
5. User forgot password	Administrator to log-in, change the password for the user. If administrator forgot the password, contact QIAGEN Technical Service.
6. Communication error between QIAcuity instrument and software	This error occurs when the data received from the instrument does not conform to the expected pattern. Further investigations are required by a QIAGEN Field Service Specialist to diagnose the problem with the instrument. Contact your distributor or QIAGEN Technical Service.

Comments and suggestions

7. Instrument software or Software Suite is unresponsive	Re-start the QIAcuity instrument or the notebook where the QIAcuity Software Suite is installed
8. Startup of instruments displays an error	The required plate recovery task cannot be performed because there are no plate slots available in the tray. Remove all loaded plates before you proceed. Press Restart to start recovery.
9. Error 205 or Error 32	The error can occur in different situations: (A) Make sure that the selected Plate type corresponds with the entered barcode, if manually entered. If not matching, it will lead to an error on the instrument (error 205). (B) Make sure that after the first successful suite connection, the instrument is restarted to allow automatic synchronization of labware files.
10. Error 490	The error can occur after a plate was processed and a failure in image transfer to the Suite was detected. The Suite rejected a data package due to improper format. See if all images are available in the Suite. If you find images missing, add an additional imaging step to recover the data.
11. Unidentified error occurs during upgrade	Check the log file for following entries: "Backup failed: Backup fail: There is not enough disk space for backup" or "Data size: x MB, free disk space: x MB"
13. Error 300 during startup of instrument	The Thermocycle requires a minimum ambient temperature inside the instrument of 17°C. Thus, the Error 300 might occur in locations, where room temperature could sink below 17°C. If the Error 300 is raised during start up, when the instrument has been shut down for a longer period, a warm-up phase is required. Turn on the instrument for 30–60 min. After this time clear the Error and restart. The instrument should start without an Error. If the Error persists, contact QIAGEN Technical Services.
14. Error 33	The error can occur if the instrument was shut down with plates loaded to all plate slots or an error occurred in a fully loaded instrument. During startup, the instrument starts a recovery sequence requiring a free slot in the drawer. Therefore, Error 33 is raised and asks you to unload at least 1 slot, clear the error, and restart.
15. Empty running screen and CSW version 0.0.0.0 and no connection with Network and Software Suite	The error can occur very rarely after clearing errors and can be solved by restarting the instrument.
16. Error 177	This error can occur when the teaching for the Hand was not performed properly and can occur for following modules: Drawer, Primer, and Thermocycler. Automatic positioning is implemented to prevent system from throwing the error, yet if it happens, the error needs to be cleared manually via Tools > System status > Clear errors . If the error keeps appearing, Hand teaching needs to be performed by the FSE team member.

9.8. Accessing the system status and clearing errors

Note: Only administrators can access the instrument status.

The QIAcuity allows you to see the status of each of its modules. This is especially useful when a hardware error occurs. Details about errors that occurred on the instrument are shown in the **System Status** section. After viewing the information, administrators can clear errors and restart the instrument to initialize all the modules.

To access the System Status environment and clear errors, follows the steps below.

1. On the toolbar, tap **Tools**.
2. Tap **Servicing**.
3. In the Servicing tab, tap **System Status**.

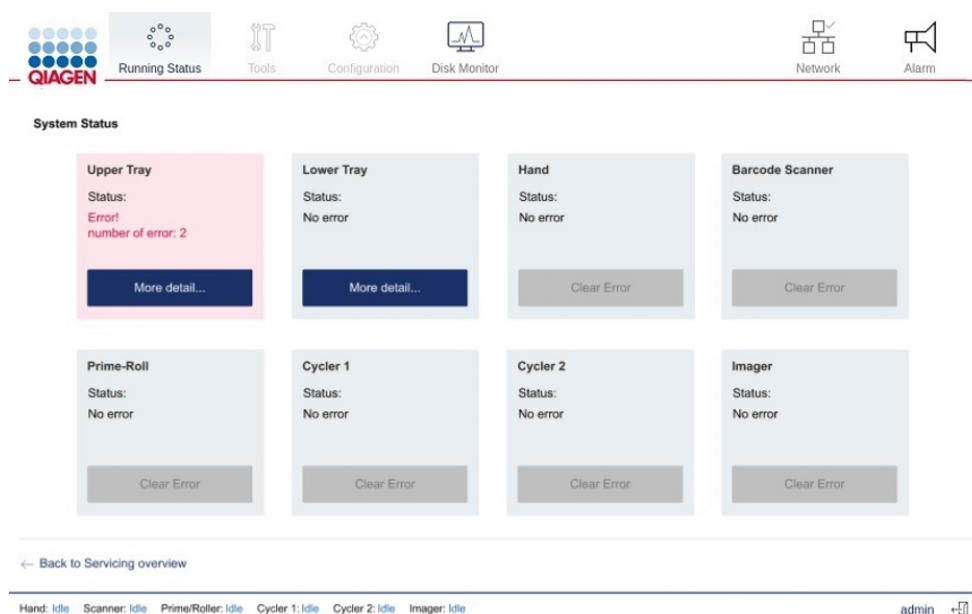

System status environment on the QIAcuity Eight after an error occurs.

4. To clear an error, tap **Clear error**.
5. If the error that occurred affects the tray(s), tap **More details**. To clear a tray-related error, tap **Clear error** in the dialog. The dialog box contains five items that can be cleared for each tray, such as motor and slot numbers (based on the instrument version).

Note: In QIAcuity Eight, the **More details** button is located in the Upper Tray and Lower Tray panes. In the QIAcuity Four and QIAcuity One, the **More details** button is located in the Tray pane.

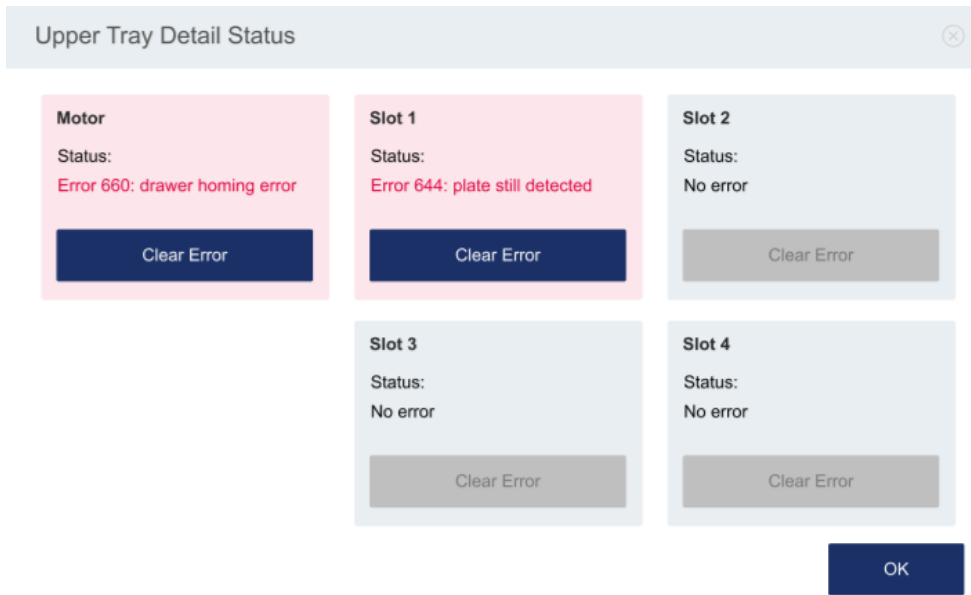

6. Restart the instrument. The instrument initializes and all modules are returned to their home positions.

Note: If the affected module is not working after you cleared the error and restarted the instrument, contact QIAGEN Technical Services.

10. Technical Specifications

QIAGEN reserves the right to change specifications at any time.

10.1. Operating conditions

Power	100–240 V AC, 50/60 Hz, Mains supply voltage fluctuations are not to exceed 10% of nominal supply voltages. Maximum power consumption: QIAcuity One, 2plex: 1000 VA QIAcuity Four: 1000 VA QIAcuity Eight: 1500 VA
--------------	--

Fuse	2x T12A L 250 V
Overtoltage category	II
Air temperature	15–32°C (59.0–89.6°F)
Relative humidity	10–75% (non-condensing)
Altitude	Up to 2000 m (6500 ft.)
Place of operation	For indoor use only
Pollution level	2
Environmental class	3K21 (IEC 60721-3-3)

10.2. Transport conditions

Air temperature	–25°C to 60°C (–13°F to 140°F) in manufacturer’s package
------------------------	--

Relative humidity	5% to 85% (non-condensing)
Environmental class	2K11 & 2M4 (IEC 60721-3-2)
Ambient pressure	700 to 1060 hPa

10.3. Storage conditions

Air temperature	5°C to 40°C (41°F to 104°F) in manufacturer’s package
------------------------	---

Relative humidity	5% to 85% (non-condensing)
Environmental class	1K21 (IEC 60721-3-1)
Ambient pressure	700 to 1060 hPa

10.4. Mechanical data and hardware features

Dimensions Four/Eight	Width: 60 cm (23.6 in.) Height: 58 cm (22.8 in.) Depth: 65 cm (25.6 in.)																					
Dimensions One	Width: 38 cm (15.0 in.) Height: 45 cm (17.7 in.) Depth: 65 cm (25.6 in.)																					
Mass	QIAcuity One: 36.0 kg (79.4 lb.) QIAcuity Four: 43.0 kg (94.8 lb.) QIAcuity Eight: 55.0 kg (121.3 lb.) Accessories: 3.0 kg (6.6 lb.)																					
Thermal specifications	Process temperature: 35°C to 99°C Ramp rate: approx. 3.0°C/s Accuracy: ±1°C Homogeneity (over plate surface): ±1°C The QIAcuity Eight features two Thermocyclers that are operated in parallel																					
Optical specifications	The 2-plex version features the channels Green and Yellow and the 5-plex version all following channels: <table border="1" data-bbox="550 913 1433 1043"> <thead> <tr> <th>Channel</th> <th>Green</th> <th>Yellow</th> <th>Orange</th> <th>Red</th> <th>Crimson</th> <th>Far red</th> </tr> </thead> <tbody> <tr> <td>Excitation in nm</td> <td>463–503</td> <td>513–534</td> <td>541–563</td> <td>568–594</td> <td>588–638</td> <td>651–690</td> </tr> <tr> <td>Emission in nm</td> <td>519–549</td> <td>551–565</td> <td>582–608</td> <td>613–655</td> <td>656–694</td> <td>709–759</td> </tr> </tbody> </table> <p>Excitation by high power white LED with average 4750 lumens Image acquisition by CMOS camera with 6.3 MP</p>	Channel	Green	Yellow	Orange	Red	Crimson	Far red	Excitation in nm	463–503	513–534	541–563	568–594	588–638	651–690	Emission in nm	519–549	551–565	582–608	613–655	656–694	709–759
Channel	Green	Yellow	Orange	Red	Crimson	Far red																
Excitation in nm	463–503	513–534	541–563	568–594	588–638	651–690																
Emission in nm	519–549	551–565	582–608	613–655	656–694	709–759																
Capacity	Up to 96 samples per plate. Maximum plate capacity depends on the configuration (One, Four, Eight)																					
Touchscreen (Four/Eight)	10.1" LCD Touch, active area 218.0 x 136.6 mm, resolution 1280*800 HD																					
Touchscreen (One)	7.0" LCD Touch, active area 150.4 x 94.2 mm, resolution 1280*800 HD																					
Acoustic emission	QIAcuity One: Max. 57.4 dB (A) QIAcuity Four/Eight: Max. 54.6 dB (A)																					
USB drive	USB2.0 8GB Compatible OS: Windows 7 or later; Mac OS X 10.1 or later Operating temperature range: 0 to 35°C Operating humidity range: 10 to 90% (with no condensation) Storage temperature range: -20°C to 60°C (-4°F to 140°F) Storage humidity range: 10 to 90% (with no condensation) Formatting: FAT32																					
Handheld scanner (optional)	Scan Pattern: Area Image (1280 x 80 pixel array) Motion Tolerance: Up to 89 cm/s (35 in/s) Print Contrast Ratio: 15% (minimum) Decode Capability: Reads standard 1D, 2D, Postal and stacked codes Resolution: 1D Linear: 0.102 mm/4 mils; PDF417: 0.127 mm/5 mils; Data Matrix: 0.195 mm/7.5 mils																					

11. Glossary

Glossary terms are listed in alphabetical order.

Term	Description
Acquisition	The collection of fluorescent data at the end of the run
Channel	A channel consists of a light emitting diode (LED) with an excitation filter paired with an emission filter The LED and excitation filter excite samples at a given wavelength. Fluorescence emitted by samples is passed through the emission filter, before being detected by the camera.
Confidence Interval	Indicates the range of values that is likely to contain the true parameter value
dPCR parameters	Parameters specifying a PCR run (e.g., number of cycles, temperature, acquisitions, etc.)
Environment	The QIAcuity Software Suite consists of several environments (e.g., "Plates", "Templates", "Analysis", "Report"). In these environments, certain tasks can be performed, such as setting up a run or analyze data.
Error code	A 3- or 4-digit number that indicates an error of the QIAcuity
Exposure duration	The length of time the samples are exposed to light during the fluorescence acquisition
Gain	A setting to amplify the fluorescence signal If the gain is set too high, the signal is oversaturated. If the gain is set too low, it is not possible to differentiate signal from background noise.
GUI	Graphical user interface
Initialization	An operation performed automatically when the QIAcuity is switched on or by initiating a self-check of the instrument, if required
Nanoplate	dPCR plate with several single partitions
Optical configuration	The optical configuration of a QIAcuity instrument is described by the available channels to detect fluorescence signals. The optical configuration differs between different types of the QIAcuity instruments.
Partition	Compartment in the Nanoplate where the PCR reaction takes place
Plate seal	Foil to be applied on top of the plate to prevent evaporation and contamination
Power switch	A button located at the front of the QIAcuity in the bottom-right corner It allows the user to switch the QIAcuity on and off; inner position is ON and outer position is OFF.
Priming	Filling of the partitions with the reaction volume
Rolling	Separation of the single partitions filled with the reaction volume
Support Package	Information wrapped up in a *.zip file to be sent via an email program to QIAGEN Technical Services to inform QIAGEN what went wrong at the customer's site and how to help the customer
Touchscreen	The user interface that allows the user to operate the QIAcuity
VPF	Volume Precision Factor. The VPF specifies the exact cycled volume of a well within a Nanoplate and therefore further increases precision of concentration calculation in each well.

Appendix A

Declaration of conformity

Name and address of the legal manufacturer:

QIAGEN GmbH
QIAGEN Strasse 1
40724 Hilden
Germany

An up-to-date declaration of conformity can be requested from QIAGEN Technical Services.

Waste Electrical and Electronic Equipment (WEEE)

This section provides information about disposal of waste electrical and electronic equipment by users.

The crossed-out wheeled bin symbol (see below) indicates that this product must not be disposed of with other waste; it must be taken to an approved treatment facility or to a designated collection point for recycling, according to local laws and regulations.

The separate collection and recycling of waste electronic equipment at the time of disposal helps to conserve natural resources and ensures that the product is recycled in a manner that protects human health and the environment.



Recycling can be provided by QIAGEN upon request at additional cost. In the European Union, in accordance with the specific WEEE recycling requirements and where a replacement product is being supplied by QIAGEN, free recycling of its WEEE-marked electronic equipment is provided.

To recycle electronic equipment, contact your local QIAGEN sales office for the required return form. Once the form is submitted, you will be contacted by QIAGEN either to request follow-up information for scheduling collection of the electronic waste or to provide you with an individual quote.

California Proposition 65

WARNING



Using this product can expose you to chemicals including lead acetate, which is known to the state of California to cause cancer and DEHP, which is known to the State of California to cause birth defects and/or other reproductive harm. For more information, go to www.P65Warnings.ca.gov

Liability Clause

QIAGEN shall be released from all obligations under its warranty in the event repairs or modifications are made by persons other than its own personnel, except in cases where the Company has given its written consent to perform such repairs or modifications.

All materials replaced under this warranty will be warranted only for the duration of the original warranty period, and in no case beyond the original expiration date of original warranty unless authorized in writing by an officer of the Company. Read-out devices, interfacing devices, and associated software will be warranted only for the period offered by the original manufacturer of these products. Representations and warranties made by any person, including representatives of QIAGEN, which are inconsistent or in conflict with the conditions in this warranty shall not be binding upon the Company unless produced in writing and approved by an officer of QIAGEN.

Declaration list of China RoHS (SJ/T 11364-2014)

The environmental friendly use period of the QIAcuity instruments is 25 years. The marking for the Restricted Use of Hazardous Substances in Electronic and Electrical Products (SJ/T 11364-2014) is shown in Table 20.

Table 20. Marking for the restricted use of hazardous substances in electronic and electrical products (SJ/T 11364-2014)

Part Name 部件名称	Toxic or Hazardous Substances and Element 有毒或有害的物质成分					
	Lead (Pb) 铅	Mercury (Hg) 汞	Cadmium (Cd) 镉	Hexavalent Chromium (Cr6+) 六价铬	Polybrominated biphenyls (PBB) 多溴联苯	Polybrominated diphenyl ethers (PBDE) 多溴联苯醚
Plastics 塑料						
Enclosure/ Plastics parts 外壳/ 塑料部件	○	○	○	○	○	○
Mechanical units 机械部分						
Chassis/ Moving parts 底盘/ 可动部分	○	○	○	○	○	○

Table 20. Marking for the restricted use of hazardous substances in electronic and electrical products (SJ/T 11364-2014) (continued)

Part Name 部件名称	Toxic or Hazardous Substances and Element 有毒或有害的物质成分					
	Lead (Pb) 铅	Mercury (Hg) 汞	Cadmium (Cd) 镉	Hexavalent Chromium (Cr6+) 六价铬	Polybrominated biphenyls (PBB) 多溴联苯	Polybrominated diphenyl ethers (PBDE) 多溴联苯醚
Shielding/ apertures/ covers 罩/ 光圈/ 盖	○	○	○	○	○	○
Electrical Units 电器部分						
PCBs a. components/ Sensors 印刷电路板部分/ 传感器	X	○	○	○	○	○
Power supply 电源	X	○	○	○	○	○
Cables 电缆						
Connecting cables 连接电缆	○	○	○	○	○	○
Motors 电机						
Motors/ Pumps/ Fans 电机/ 泵/ 风扇	○	○	○	○	○	○
Optical Parts 光学部件						
Filter/ Lenses 滤光器/ 镜头	○	○	○	○	○	○
Heating Unit 加热装置						
Thermocycler 散热片	○	○	○	○	○	○

Note: This table is prepared in accordance with the provisions of SJ/T 11364.

○: Indicates that this toxic or hazardous substance contained in all of the homogeneous materials for this part is below the limit requirement in GB/T 26572.

○: 代表用于此部件的所有同类型的包含该种有毒或者有害物质的材料均在GB/T 26572的规定界限以下

X: Indicates that this toxic or hazardous substance contained in at least one of the homogeneous materials used for this part may be above the limit requirement in GB/T 26572.

X: 代表用于此部件的至少一种此类型的包含该种有毒或者有害物质的材料可能在GB/T 26572的规定界限以上

Appendix B — QIAcuity Accessories

For more information and an up-to-date list of available protocols, visit www.qiagen.com

Ordering information

Product	Contents	Cat. no.
QIAcuity One, 2plex Platform System FUL-13F*	One-plate digital PCR instrument for detecting up to 2 fluorescent dyes, notebook computer, Nanoplate Roller, USB flash memory, and QIAcuity Software Suite: includes installation, training, full agreement for 1 year with a 2 business day response time, and 1 preventive maintenance visit	911015
QIAcuity One, 5plex Platform System FUL-1*	One-plate digital PCR instrument for detecting up to 2 fluorescent dyes, notebook computer, Nanoplate Roller, USB flash memory, and QIAcuity Software Suite: includes installation, training, full agreement for 1 year with a 2 business day response time, and 1 preventive maintenance visit	911035
QIAcuity Four Platform System FUL-1*†	Four-plate digital PCR instrument for detecting up to 8 fluorescent dyes, notebook computer, barcode scanner, Nanoplate Roller, USB flash memory, and QIAcuity Software Suite; Includes installation, training, full agreement for 1 year with a 2 business day response time, and 1 preventive maintenance visit	911045
QIAcuity Eight Platform System FUL-1*†	Eight-plate digital PCR instrument for detecting up to 8 fluorescent dyes, notebook computer, barcode scanner, Nanoplate Roller, USB flash memory, and QIAcuity Software Suite: includes installation, training, full agreement for 1 year with a 2-business day response time, and 1 preventive maintenance visit	911055
QIAcuity, IQ/OQ product	Installation Qualification and Operational Qualification of QIAcuity provides documented verification that the instrument has been properly installed, and is operating according to the manufacturer's specifications. IQ/OQ Service is an on-site qualification service provided by a certified QIAGEN Service Specialist. This includes labor and travel	9245414
Barcode Hand Scanner, QIAcuity	Separate 2D barcode scanner for reading of QIAcuity Nanoplate IDs outside of the QIAcuity instrument	911106
Roller, QIAcuity	Nanoplate Roller for fixing the Nanoplate seal on QIAcuity Nanoplates	911105
Air Filter, QIAcuity One (1)	Replacement air inlet filter for QIAcuity One	9026699
Air Filter, QIAcuity Four/Eight (1)	Replacement air inlet filter for QIAcuity Four and QIAcuity Eight	9026700
QIAcuity Nanoplate 26k 24-well (10)	24-well dPCR Nanoplate with 26K partitions and 40 µL reaction volume per well, including Nanoplate seals	250001
QIAcuity Nanoplate 8.5k 24-well (10)	24-well dPCR Nanoplate with 8.5K partitions and 12 µL reaction volume per well, including Nanoplate seals	250011
QIAcuity Nanoplate 8.5k 96-well (10)	96-well dPCR Nanoplate with 8.5K partitions and 12 µL reaction volume per well, including Nanoplate seals	250021

Product	Contents	Cat. no.
QIAcuity Nanoplate 26k 8-well (10)	8-well dPCR Nanoplate with 26K partitions and 40 µL reaction volume per well, including Nanoplate seals	250031
Nanoplate Seals (11)	Nanoplate seal for sealing QIAcuity Nanoplates	250099
Nanoplate Tray (2)	Nanoplate Tray improving plate-handling during pipetting or carrying	250098
QIAcuity Probe PCR Kit (1 mL)	1 mL 4x concentrated QIAcuity Probe Mastermix, 2 x 1.9 mL Water	250101
QIAcuity Probe PCR Kit (5 mL)	5 x 1 mL 4x concentrated QIAcuity Probe Mastermix, 8 x 1.9 mL Water	250102
QIAcuity Probe PCR Kit (25 mL)	5 x 5 mL 4x concentrated QIAcuity Probe Mastermix, 4 x 20 mL Water	250103
QIAcuity EG PCR Kit (1 mL)	1 mL 3x concentrated QIAcuity EvaGreen Mastermix, 2 x 1.9 mL Water	250111
QIAcuity EG PCR Kit (5 mL)	5 x 1 mL 3x concentrated QIAcuity EvaGreen Mastermix, 8 x 1.9 mL Water	250112
QIAcuity EG PCR Kit (25 mL)	5 x 5 mL 3x concentrated QIAcuity EvaGreen Mastermix, 4 x 20 mL Water	250113

* Additional instrument and Service bundles are available.

† For all systems, Installation and Training is included but are additionally available as separate service offerings. For specific catalog numbers and additional information, visit www.qiagen.com or contact your local sales representative.

For up-to-date licensing information and product-specific disclaimers, see the respective QIAGEN kit handbook or user manual. QIAGEN kit handbooks and user manuals are available at www.qiagen.com or can be requested from QIAGEN Technical Services or your local distributor.

Appendix C – Informations de sécurité

Avant d'utiliser le QIAcuity, il est impératif de lire attentivement ce manuel et de porter attention aux informations de sécurité. Pour garantir un fonctionnement de l'appareil en toute sécurité et le maintenir en bon état de marche, il est impératif de suivre les instructions et les informations de sécurité fournies dans le manuel.

Remarque : les traductions française et allemande des informations de sécurité sont disponibles à l'annexe C – Informations de sécurité et à l'annexe D – Sicherheitshinweise.

Les types d'informations de sécurité suivants sont fournis dans ce manuel.

AVERTISSEMENT



Le terme AVERTISSEMENT est utilisé pour vous informer de situations qui pourraient entraîner des blessures corporelles pour vous ou d'autres personnes.

Les détails concernant ces circonstances sont donnés dans un encadré identique à celui-ci.

ATTENTION



Le terme ATTENTION est utilisé pour indiquer des situations pouvant entraîner un endommagement de l'instrument ou d'autres équipements.

Les détails concernant ces circonstances sont donnés dans un encadré identique à celui-ci.

Les conseils dispensés dans ce manuel ont pour but de venir compléter les exigences de sécurité habituelles en vigueur dans le pays de l'utilisateur, et non de s'y substituer.

Utilisation appropriée

AVERTISSEMENT



Risque de dommages corporels et matériels

Une utilisation inappropriée du QIAcuity peut entraîner des blessures corporelles ou une détérioration de l'appareil. Le QIAcuity ne doit être utilisé que par du personnel qualifié ayant été convenablement formé.

L'entretien du QIAcuity ne doit être effectué que par un spécialiste de l'entretien sur site QIAGEN.

Procéder à la maintenance comme décrit dans la section Procédures de maintenance. QIAGEN facture les réparations dues à une maintenance incorrecte.

AVERTISSEMENT



Risque de dommages corporels et matériels

L'appareil QIAcuity est trop lourd pour être soulevé par une seule personne. Afin d'éviter tout accident corporel et toute détérioration du matériel, ne pas soulever l'appareil seul. La plaque inférieure doit être utilisée pour le levage. Ne pas soulever l'appareil en le tenant par l'écran tactile.

AVERTISSEMENT



Risque de dommages corporels et matériels

Ne pas essayer de déplacer le QIAcuity pendant qu'il est en marche.

ATTENTION



Détérioration de l'appareil

Éviter de renverser de l'eau ou des produits chimiques sur le QIAcuity. La détérioration due à la projection d'eau ou de produits chimiques annulera la garantie.

En cas d'urgence, éteindre le QIAcuity à l'aide de l'interrupteur d'alimentation situé à l'arrière de l'appareil et débrancher le câble d'alimentation de la prise secteur.

ATTENTION Détérioration de l'appareil



Utiliser les consommables pour QIAcuity avec le QIAcuity. Ne pas utiliser de plaques sans couvercles. Les détériorations causées par l'utilisation d'autres consommables annulent la garantie.

ATTENTION Détérioration de l'appareil



Ne pas faire tomber d'objets dans l'appareil quand le plateau de plaque est éjecté.

AVERTISSEMENT Risque d'explosion



Le QIAcuity est conçu pour être utilisé avec les réactifs et les substances fournis avec les kits QIAGEN ou autrement que de la façon décrite dans le mode d'emploi correspondant. L'utilisation d'autres réactifs et d'autres substances peut provoquer un incendie ou une explosion.

ATTENTION Détérioration de l'appareil



Ne pas empiler les instruments et ne pas placer de produits sur le QIAcuity.

ATTENTION Détérioration de l'appareil



Ne pas vous appuyer contre l'écran tactile lorsqu'il est déboîté.

Sécurité électrique

Remarque : avant l'entretien, débrancher le cordon d'alimentation de la prise de courant.

AVERTISSEMENT Danger électrique



Toute interruption du conducteur de protection (conducteur de terre/de masse) à l'intérieur ou à l'extérieur de l'appareil ou toute déconnexion de la borne du conducteur de protection est susceptible de rendre l'appareil dangereux.

Toute interruption intentionnelle est interdite.

Tensions mortelles à l'intérieur de l'appareil

Lorsque l'appareil est relié à l'alimentation, les bornes peuvent être sous tension et l'ouverture de capots ou le retrait d'éléments risque d'exposer des éléments sous tension.

AVERTISSEMENT Endommagement des composants électroniques



Avant de mettre l'appareil SOUS tension, vérifier que vous utilisez la bonne tension d'alimentation. L'utilisation d'une tension d'alimentation incorrecte risque d'endommager les composants électroniques.

Pour prendre connaissance de la tension d'alimentation recommandée, consulter les spécifications indiquées sur la plaque signalétique de l'appareil.

AVERTISSEMENT **Risque de décharge électrique**



Ne pas ouvrir pas les panneaux du QIAcuity.

Risque de dommages corporels et matériels

Effectuer uniquement la maintenance qui est décrite spécifiquement dans le présent manuel d'utilisation.

Afin que le QIAcuity fonctionne de manière satisfaisante et en toute sécurité, suivre ces instructions :

1. Le câble d'alimentation doit être relié à une prise d'alimentation disposant d'un conducteur de protection (terre/masse).
2. Ne pas modifier ou remplacer des composants internes de l'appareil.
3. Ne pas faire fonctionner l'appareil en ayant retiré des capots ou des composants.
4. Si un liquide s'est répandu à l'intérieur de l'appareil, l'éteindre, le déconnecter de la prise secteur et prendre contact avec les services techniques de QIAGEN.

Si l'appareil présente un danger électrique, empêcher le reste du personnel de s'en servir et contacter les services techniques de QIAGEN.

L'appareil peut présenter un danger électrique dans les cas suivants:

5. L'appareil ou le câble d'alimentation semble être détérioré.
6. Il a été stocké dans des conditions défavorables pendant une longue période.
7. Il a subi des chocs sévères durant le transport.
8. Des liquides entrent en contact direct avec les composants électriques du QIAcuity.

Environnement

Conditions de fonctionnement

AVERTISSEMENT **Atmosphère explosive**



Le QIAcuity n'est pas conçu pour être utilisé dans une atmosphère explosive.

ATTENTION **Détérioration de l'appareil**



L'exposition à la lumière solaire directe peut provoquer le blanchiment de certains éléments de l'appareil et détériorer les pièces en plastique.

Le QIAcuity doit être tenu à l'abri de la lumière directe du soleil.

ATTENTION **Risque de surchauffe**



Afin de garantir une bonne ventilation, laisser un dégagement d'au moins 10 cm sur les côtés et à l'arrière du QIAcuity.

Les fentes et les ouvertures qui garantissent la ventilation du QIAcuity ne doivent pas être obstruées.

Sécurité biologique

Les prélèvements et les réactifs contenant des matières provenant d'êtres humains doivent être considérés comme potentiellement infectieux. Utiliser des procédures de laboratoire sûres, comme décrites dans des publications telles que Biosafety in Microbiological and Biomedical Laboratories, HHS (www.cdc.gov/labs/BMBL.html).

11.0.1. Échantillons

Les échantillons peuvent contenir des agents infectieux. Vous devez connaître le risque pour la santé que ces agents représentent et vous devez utiliser, stocker et mettre au rebut ce genre d'échantillons conformément aux règles de sécurité nécessaires.

AVERTISSEMENT Échantillons contenant des agents infectieux



Certains échantillons utilisés avec cet appareil peuvent contenir des agents infectieux. Manipuler ces échantillons avec la plus grande précaution et conformément aux règles de sécurité nécessaires.

Toujours porter des lunettes de protection, 2 paires de gants et une blouse de laboratoire.

La personne responsable (par exemple, le directeur du laboratoire) doit prendre les précautions nécessaires afin de garantir que le lieu de travail environnant est sûr et que les opérateurs de l'appareil sont convenablement formés et ne sont pas exposés à des niveaux dangereux d'agents infectieux comme cela est défini dans les fiches techniques santé-sécurité (Material Safety Data Sheets, MSDSs) ou dans les documents de l'OSHA,* de l'ACGIH,[†] or ou du COSHH[‡] applicables.

L'évacuation des vapeurs et la mise au rebut des déchets doivent être effectuées conformément à toutes les réglementations et lois nationales, régionales et locales relatives à la santé et à la sécurité.

* OSHA – Occupational Safety and Health Organization (United States of America)

[†] ACGIH – American Conference of Government Industrial Hygienists (United States of America)

[‡] COSHH – Control of Substances Hazardous to Health (United Kingdom)

Produits chimiques

AVERTISSEMENT Produits chimiques dangereux



Certains produits chimiques utilisés avec cet appareil peuvent être dangereux ou le devenir après l'exécution du cycle du protocole.

Toujours porter des lunettes de protection, des gants et une blouse de laboratoire.

La personne responsable (par exemple, le directeur de laboratoire) doit prendre les précautions nécessaires afin de garantir que le lieu de travail environnant est sûr et que les opérateurs de l'appareil ne sont pas exposés à des niveaux dangereux de substances toxiques (chimiques ou biologiques) comme cela est défini dans les fiches techniques de sécurité (Safety Data Sheets, SDS) ou dans les documents de l'OSHA,* de l'ACGIH,[†] or ou du COSHH[‡] applicables.

L'évacuation des vapeurs et la mise au rebut des déchets doivent être effectuées conformément à toutes les réglementations et lois nationales, régionales et locales relatives à la santé et à la sécurité.

* OSHA – Occupational Safety and Health Organization (United States of America)

[†] ACGIH – American Conference of Government Industrial Hygienists (United States of America)

[‡] COSHH – Control of Substances Hazardous to Health (United Kingdom)

Sécurité de maintenance

**AVERTISSEMENT/
ATTENTION**



Risque de dommages corporels et matériels

Effectuer uniquement la maintenance qui est décrite spécifiquement dans le présent manuel d'utilisation.

AVERTISSEMENT



Risque d'incendie

Ne pas laisser le liquide de nettoyage ou les agents de décontamination entrer en contact avec les Pièce électriques du QIAcuity.

ATTENTION



Détérioration de l'appareil

Ne pas utiliser de produit à base d'eau de Javel, de solvants ou de réactifs contenant des acides, des agents alcalins ou des produits abrasifs pour nettoyer le QIAcuity.

ATTENTION



Détérioration de l'appareil

Ne pas utiliser pas de flacons pulvérisateurs contenant de l'alcool ou un agent désinfectant pour nettoyer les surfaces du QIAcuity.

Sécurité contre les rayonnements

AVERTISSEMENT



Risque de dommages corporels

Lumière laser avec niveau de danger 2 : Ne pas regarder fixement le faisceau lumineux lors de l'utilisation du lecteur de code-barres portable.

Symboles sur le QIAcuity

Symbole	Emplacement	Description
	Plaque signalétique à l'arrière de l'appareil	Marquage CE pour la conformité européenne
	Plaque signalétique à l'arrière de l'appareil	Marquage UKCA pour la conformité UK
	Plaque signalétique à l'arrière de l'appareil	Label CSA pour le Canada et les États-Unis
	Plaque signalétique à l'arrière de l'appareil	Marquage RCM pour l'Australie et la Nouvelle-Zélande
	Plaque signalétique à l'arrière de l'appareil	Marquage RoHS pour la Chine (restriction de l'utilisation de certaines substances dangereuses dans les équipements électriques et électroniques)
	Plaque signalétique à l'arrière de l'appareil	Marquage de déchets d'équipements électriques et électroniques (DEEE) pour l'Europe
	Plaque signalétique à l'arrière de l'appareil	Fabricant légal
	Plaque signalétique à l'arrière de l'appareil	Consulter le mode d'emploi
	Plaque signalétique à l'arrière de l'appareil	Voir chapitre Informations de sécurité pour les risques
	Plaque signalétique à l'arrière de l'appareil	Date de fabrication
	Sur le tiroir	Risque biologique – certains échantillons utilisés avec cet appareil peuvent contenir des agents infectieux et doivent être manipulés avec des gants.

Appendix D – Sicherheitshinweise

Vor der Inbetriebnahme des QIAcuity sollten Sie dieses Benutzerhandbuch sorgfältig durchlesen und die Sicherheitshinweise beachten. Die Anweisungen und Sicherheitshinweise in diesem Benutzerhandbuch müssen vom Benutzer befolgt werden, um einen sicheren Betrieb des Geräts zu gewährleisten und das Gerät in einem sicheren Zustand zu erhalten.

Hinweis: Übersetzungen der Sicherheitshinweise in Französisch und Deutsch finden Sie in Anhang C – Informations de sécurité und Anhang D – Sicherheitshinweise.

In diesem Handbuch werden die folgenden Typen von Sicherheitshinweisen verwendet.

WARNUNG Mit dem Begriff **WARNUNG** wird über Situationen informiert, die zu einer Verletzung für Sie oder andere Personen führen könnten.



Nähere Einzelheiten über diese Situationen werden in einem Textfeld wie diesem beschrieben.

VORSICHT Der Begriff **VORSICHT** wird verwendet, um Sie über Situationen zu informieren, in denen die Gefahr besteht, dass das System oder andere Geräte beschädigt werden.



Nähere Einzelheiten über diese Situationen werden in einem Textfeld wie diesem beschrieben.

Die in diesem Handbuch enthaltenen Hinweise sollen die im jeweiligen Land des Anwenders geltenden Sicherheitsbestimmungen nicht ersetzen, sondern lediglich ergänzen.

Sachgemäße Handhabung

WARNUNG **Gefahr von Personen- und Sachschäden**



Die unsachgemäße Anwendung des QIAcuity kann zu Verletzungen des Benutzers oder zur Beschädigung des Geräts führen. Die Bedienung des QIAcuity darf nur durch qualifiziertes, entsprechend geschultes Personal erfolgen.

Die Instandhaltung des QIAcuity darf nur durch einen Service-Spezialisten des QIAGEN Außendienstes durchgeführt werden.

Führen Sie alle Wartungsarbeiten gemäß den Anweisungen im Abschnitt **Wartungsarbeiten** dieses Handbuchs durch. QIAGEN stellt Reparaturen, die auf nicht fachgerecht durchgeführte Wartungsmaßnahmen zurückzuführen sind, in Rechnung.

WARNUNG **Gefahr von Personen- und Sachschäden**



Der QIAcuity ist sehr schwer und sollte nicht von einer Person angehoben werden. Heben Sie das Gerät nicht allein an, um eine Verletzung und/oder Beschädigung des Geräts zu vermeiden. Beim Heben ist das Gerät an der Unterseite anzufassen. Fassen Sie das Gerät zum Heben nicht am Touchscreen an.

WARNUNG **Gefahr von Personen- und Sachschäden**



Bewegen Sie den QIAcuity auf keinen Fall während des Betriebs.

VORSICHT**Beschädigung des Geräts**

Verschütten Sie keine Flüssigkeiten oder Chemikalien auf dem QIAcuity. Durch verschüttetes Wasser oder verschüttete Chemikalien verursachte Schäden führen zum Erlöschen der Garantie.

Schalten Sie den QIAcuity im Notfall am Netzschalter auf der Rückseite des Geräts AUS und ziehen Sie das Netzkabel aus der Netzsteckdose.

VORSICHT**Beschädigung des Geräts**

Verwenden Sie nur für den QIAcuity vorgesehene Verbrauchsmaterialien mit dem QIAcuity. Verwenden Sie keine Platten ohne angebrachte Versiegelung. Kommt es bei der Verwendung anderer Verbrauchsartikeln anderer Hersteller zu Geräteschäden, erlischt Ihre Garantie.

VORSICHT**Beschädigung des Geräts**

Lassen Sie keine Gegenstände in das Gerät fallen, wenn das Plattentablett ausgeworfen wird.

WARNUNG**Explosionsgefahr**

Der QIAcuity darf ausschließlich mit Reagenzien und Substanzen aus den QIAGEN Kits bzw. gemäß den Angaben in der entsprechenden Gebrauchsanweisung verwendet werden. Die Verwendung anderer Reagenzien und Substanzen kann zu einem Brand oder zu einer Explosion führen.

VORSICHT**Beschädigung des Geräts**

Stapeln Sie keine Geräte aufeinander und stellen Sie keine Gegenstände auf den QIAcuity.

VORSICHT**Beschädigung des Geräts**

Lehnen Sie sich nicht an den Touchscreen, wenn er herausgezogen ist.

Schutz vor Stromschlag

Hinweis: Ziehen Sie das Netzanschlusskabel aus der Steckdose, bevor Sie Instandhaltungs-/Wartungsarbeiten an einem Gerät vornehmen.

WARNUNG**Stromschlaggefahr**

Jede Unterbrechung des Schutzleiters (Erdungs- bzw. Masseleiter) im Gerät oder außerhalb des Geräts und jede Abtrennung des Schutzleiters am Anschluss der Netzleitung erhöht die Gefahr eines Stromschlags.

Eine absichtliche Unterbrechung der Schutzleiterverbindung ist verboten.

Gefährliche Spannung im Gerät

Wenn das Gerät an die Stromversorgung angeschlossen ist, sind die Anschlussstellen spannungsführend. Durch das Öffnen der Abdeckungen oder das Entfernen von Gehäuseteilen können spannungsführende Komponenten freigelegt werden.

WARNUNG Beschädigung von elektronischen Bauteilen



Stellen Sie vor dem Einschalten des Geräts sicher, dass die korrekte Versorgungsspannung verwendet wird.

Eine falsche Versorgungsspannung kann Schäden an der Elektronik hervorrufen.

Überprüfen Sie die empfohlene Versorgungsspannung anhand der technischen Daten auf dem Typenschild des Geräts.

WARNUNG Gefahr durch Stromschlag



Öffnen Sie keine der Abdeckplatten des QIAcuity.

Gefahr von Personen- und Sachschäden

Es dürfen nur Wartungsarbeiten ausgeführt werden, die in diesem Benutzerhandbuch konkret beschrieben sind.

Um einen zufriedenstellenden und sicheren Betrieb des QIAcuity zu gewährleisten, befolgen Sie bitte die nachstehenden Hinweise:

1. Das Netzkabel muss an eine Wechselstrom-Steckdose mit Schutzleiter (Erdungs-/Masseleiter) angeschlossen werden.
2. Nehmen Sie im Geräteinneren keine Einstellungen an Geräteteilen vor und wechseln Sie keine Teile aus.
3. Nehmen Sie das Gerät nicht in Betrieb, wenn Abdeckungen oder Teile entfernt worden sind.
4. Falls Flüssigkeit auf dem Gerät verschüttet wird und hineinläuft, schalten Sie es sofort AUS, ziehen Sie den Netzstecker und setzen Sie sich mit dem Technischen Service von QIAGEN in Verbindung.

Falls die elektrische Sicherheit bei der Bedienung des Geräts nicht mehr gewährleistet werden kann, muss das Gerät gegen Benutzung durch darüber nicht informiertes Personal gesichert werden. Kontaktieren Sie anschließend den Technischen Service von QIAGEN.

Die elektrische Sicherheit des Geräts ist nicht mehr gegeben, wenn:

1. das Gerät oder das Netzkabel beschädigt erscheint;
2. das Gerät für längere Zeit unter ungünstigen Bedingungen gelagert wurde;
3. das Gerät unsachgemäß transportiert worden ist.
4. Flüssigkeiten in direkten Kontakt mit elektrischen Komponenten des QIAcuity kommen.

Umgebung

Betriebsbedingungen

WARNUNG



Explosive Atmosphäre

Der QIAcuity ist nicht für den Gebrauch in explosionsfähiger Atmosphäre vorgesehen.

VORSICHT



Beschädigung des Geräts

Direktes Sonnenlicht kann zum Ausbleichen von Teilen des Geräts führen und Schäden an Kunststoffteilen verursachen.

Der QIAcuity muss an einem Ort aufgestellt werden, an dem er vor direkter Sonneneinstrahlung geschützt ist.

VORSICHT



Überhitzungsgefahr

Vergewissern Sie sich, dass ein Mindestabstand von 10 cm zwischen Seitenwänden und Rückseite des QIAcuity und der Raumwand eingehalten wird, damit eine ausreichende Belüftung des Geräts gewährleistet ist.

Lüftungsschlitze und Öffnungen, die der Be- und Entlüftung des QIAcuity dienen, dürfen nicht abgedeckt werden.

Biologische Sicherheit

Bei Substanzen und Reagenzien, die humanes Untersuchungsmaterial enthalten, sollte immer von einer möglichen Infektionsgefahr ausgegangen werden. Wenden Sie nur sichere Laborverfahren an, wie sie z. B. in Veröffentlichungen wie Biosafety in Microbiological and Biomedical Laboratories HHS, (www.cdc.gov/labs/BMBL.html) beschrieben sind.

Proben

Proben können infektiöse Erreger enthalten. Sie sollten sich der Gesundheitsgefahr bewusst sein, die von diesen Erregern ausgeht, und derartige Proben gemäß den erforderlichen Sicherheitsbestimmungen handhaben, lagern und entsorgen.

WARNUNG Proben mit infektiösen Erregern



Manche Proben, die mit diesem Gerät verwendet werden, können infektiöse Erreger enthalten. Gehen Sie beim Umgang mit diesen Proben mit der größtmöglichen Vorsicht und gemäß den erforderlichen Sicherheitsbestimmungen vor.

Tragen Sie immer eine Schutzbrille, zwei Paar Laborhandschuhe und einen Laborkittel.

Die verantwortliche Person (z. B. der Laborleiter) muss alle erforderlichen Vorsichtsmaßnahmen treffen, um sicherzustellen, dass die unmittelbare Umgebung des Arbeitsplatzes sicher ist und die Bediener des Geräts ausreichend geschult sind. Außerdem dürfen die Grenzwerte in Bezug auf infektiöse Erreger, die in den entsprechenden Sicherheitsdatenblättern (Material Safety Data Sheets, MSDS) oder den Vorschriften der OSHA, * de ACGIH,[†] oder COSHH[‡] festgelegt sind, nicht überschritten werden.

Beim Betrieb eines Abzugs und bei der Entsorgung von Abfallstoffen müssen alle Bestimmungen und Gesetze auf Bundes-, Landes- und kommunaler Ebene zu Gesundheitsschutz und Sicherheit am Arbeitsplatz eingehalten werden.

* OSHA — Occupational Safety and Health Organization (United States of America)

† ACGIH — American Conference of Government Industrial Hygienists (United States of America)

‡ COSHH — Control of Substances Hazardous to Health (United Kingdom)

Chemikalien

WARNUNG Gefährliche Chemikalien



Einige Chemikalien, die mit diesem Gerät verwendet werden, können gefährlich sein oder nach Beendigung eines Protokolllaufs gefährlich werden.

Tragen Sie immer eine Schutzbrille, Laborhandschuhe und einen Laborkittel.

Die verantwortliche Person (z. B. der Laborleiter) muss alle erforderlichen Vorsichtsmaßnahmen treffen, um sicherzustellen, dass die unmittelbare Umgebung des Arbeitsplatzes sicher ist. Außerdem dürfen die Grenzwerte in Bezug auf toxische (chemische oder biologische) Substanzen, die in den entsprechenden Sicherheitsdatenblättern (Safety Data Sheets, SDS) oder den Vorschriften der OSHA, * de ACGIH,[†] oder COSHH[‡] festgelegt sind festgelegt sind, nicht überschritten werden.

Beim Betrieb eines Abzugs und bei der Entsorgung von Abfallstoffen müssen alle Bestimmungen und Gesetze auf Bundes-, Landes- und kommunaler Ebene zu Gesundheitsschutz und Sicherheit am Arbeitsplatz eingehalten werden.

* OSHA — Occupational Safety and Health Organization (United States of America)

† ACGIH — American Conference of Government Industrial Hygienists (United States of America)

‡ COSHH — Control of Substances Hazardous to Health (United Kingdom)

Wartungssicherheit

WARNUNG/ VORSICHT



Gefahr von Personen- und Sachschäden

Es dürfen nur Wartungsarbeiten ausgeführt werden, die in diesem Benutzerhandbuch konkret beschrieben sind.

WARNUNG



Brandgefahr

Achten Sie darauf, dass keine Reinigungsflüssigkeiten oder Dekontaminationsmittel in Kontakt mit den elektrischen Bauteilen des QIAcuity kommen.

VORSICHT



Beschädigung des Geräts

Verwenden Sie keine Bleichmittel, Lösungsmittel oder Reagenzien, die Säuren, Laugen oder Abrasivstoffe enthalten, um den QIAcuity zu reinigen.

VORSICHT



Beschädigung des Geräts

Verwenden Sie keine Bleichmittel, Lösungsmittel oder Reagenzien, die Säuren, Laugen oder Abrasivstoffe enthalten, um den QIAcuity zu reinigen.

Strahlensicherheit





WARNUNG



Gefahr von Personenschäden

Laserlicht der Gefahrenklasse 2: Schauen Sie bei Verwendung des Barcode-Handscanners nicht in den Laserstrahl.

Symbole auf dem QIAcuity

Symbol	Ort	Beschreibung
	Typenschild an der Geräterückseite	CE-Markierung der EU-Konformität
	Typenschild an der Geräterückseite	UKCA-Markierung der UK-Konformität
	Typenschild an der Geräterückseite	Symbol der CSA-Zertifizierung in Kanada und den USA
	Typenschild an der Geräterückseite	RCM-Zeichen für Australien und Neuseeland
	Typenschild an der Geräterückseite	Markierung gemäß RoHS-Richtlinie für China (Einschränkungen in Bezug auf den Gebrauch bestimmter Gefahrstoffe in Elektro- und Elektronikgeräten)
	Typenschild an der Geräterückseite	WEEE-Markierung (Zertifizierung gemäß Richtlinie über Elektro- und Elektronik-Altgeräte) für Europa
	Typenschild an der Geräterückseite	Hersteller i. S. d. Gesetzes
	Typenschild an der Geräterückseite	Gebrauchsanweisung beachten
	Typenschild an der Geräterückseite	Siehe Kapitel Sicherheitshinweise bezüglich Risiken
	Typenschild an der Geräterückseite	Herstellungsdatum
	An der Schublade	Biologische Gefährdung – Einige Proben, die mit diesem Gerät verwendet werden, können infektiöse Erreger enthalten und dürfen nur mit Laborhandschuhen angefasst werden.

Appendix E – User Management Permissions

The table below shows all available permissions for the user management including short descriptions and technical names. These technical names are shown in audit trail details in case a user has made changes to any users or roles.

Permission	Technical name	Description
Log in [Instrument and PC software]		
Instrument	CSW_USER_LOGIN	User can login to Instrument (login and password is needed).
Suite Software	SUITE_USER_LOGIN	User can login to Suite Software (PC software) (login and password is needed).
Instrument accesses [Instrument software]		
Instrument Maintenance	CSW_INSTRUMENT_MAINTENANCE	User can update Instrument and go to Data Management, Self-Check, Servicing and Configuration.
Experiment Schedule	CSW_PLATE_EXPERIMENTSCHEDULE	User can set up dPCR parameters (priming, cycling, imaging).
Create Support Package	CSW_INSTRUMENT_CREATESUPPORTPACKAGE	User can download and upload support package.
Plates [Instrument and PC software]		
Create Plate	QIACUITY_PLATE_CREATE	User can set up dPCR parameters (priming, cycling, imaging), reaction mixes (reagents), samples (control, non-control) and create Plate layout.
All Plates		
Run Experiment	CSW_PLATE_ALL_RUN	User can run/stop an experiment and eject Plate(s) from Instrument.
Edit Plate Data	QIACUITY_PLATE_ALL_EDITDATA	User can check and edit parameters of existing Plate (dPCR parameters, Plate layout (samples, reaction mixes (reagents), controls), and mark it as primed.
Edit Analysis Data	SUITE_PLATE_ALL_EDITANALYSIS	User can change the threshold and use polygon selection on the Analysis page of all Plates to verify the accuracy of the results.
Read Plate	QIACUITY_PLATE_ALL_READ	User can search for specific Plate, see all created Plates, analyze a Plate, check details about a Plate (dPCR parameters, plate layout (samples, reaction mixes, controls)) and export Plate to CSV.
Delete Plate	SUITE_PLATE_ALL_DELETE	User can delete any Plates.
Owned plates		
Run Experiment	CSW_PLATE_OWNED_RUN	User can run/stop an experiment and eject owned Plate(s) from Instrument.
Edit Plate Data	QIACUITY_PLATE_OWNED_EDITDATA	User can check and edit parameters of owned Plate (dPCR parameters, plate layout (samples, reaction mixes (reagents), controls), and mark it as primed.
Edit Analysis Data	SUITE_PLATE_OWNED_EDITANALYSIS	User can change the threshold and use polygon selection on the Analysis page of the owned Plates to verify the accuracy of the results.
Read Plate	QIACUITY_PLATE_OWNED_READ	User can search the Plate, analyze the Plate, see all created Plates, check details about owned Plate (dPCR parameters, plate layout (samples, reaction mixes, controls)), export plate to CSV.
Delete Plate	SUITE_PLATE_OWNED_DELETE	User can delete owned Plates.

Permission	Technical name	Description
Other permissions		
Import Plate	SUITE_PLATE_OTHER_IMPORT	User can import the Plate as a ZIP file.
Export Plate	SUITE_PLATE_OTHER_EXPORT	User can export the Plate as a password protected ZIP file.
Unlock Plate	SUITE_PLATE_OTHER_UNLOCK	User can unlock locked Plate.
Set Plate Ownership	SUITE_PLATE_OTHER_SETPLATEOWNERSHIP	User can set owners of the plate.
Upload VPF	SUITE_PLATE_OTHER_UPLOADVPF	User can upload Volume Precision Factor.
Upgrade Plate	SUITE_PLATE_OTHER_UPGRADE	User can upgrade the Plate.
Create Support Package	SUITE_PLATE_OTHER_CREATESUPPORTPACKAGE	User can download and export support package for the Plate.
Create Report for Analysis	SUITE_PLATE_OTHER_CREATEREPORT	User can create and generate report using the charts and data from the Analysis of the Plate.
Sign Report	SUITE_PLATE_OTHER_SIGNREPORT	User can add signature to the report.
Delete Report	SUITE_PLATE_OTHER_DELETEREPORT	User can delete report.
Templates [Instrument and PC software]		
Create Template	SUITE_TEMPLATE_ALL_CREATE	User can create new Template.
Edit Template	SUITE_TEMPLATE_ALL_EDITDATA	User can edit existing Template.
Read Template	SUITE_TEMPLATE_ALL_READ	User can read information about existing Templates and use them while creating and editing plates (if also has appropriate plate permissions). Access to all created Templates.
Delete Template	SUITE_TEMPLATE_ALL_DELETE	User can delete existing Templates.
Archive [PC software]		
Plate Archiving	SUITE_PLATE_ARCHIVE_ARCHIVE	User can archive the Plate.
Archive Overview	SUITE_ARCHIVE_ARCHIVE_READ	User has access to list of archived Plates. User can see all archived Plates, search for archived Plates, check general information about archived Plate and disk space usage for the Archive in the Disk Monitor.
Restore Plate from Archive	SUITE_PLATE_ARCHIVE_ARCHIVERESTORE	User can restore archived Plates.
Delete plate from Archive	SUITE_PLATE_ARCHIVE_ARCHIVEDDELETE	User can delete any Plate from Archive.
User Management [PC software]		
Read Users and Roles	SUITE_USER_ROLE_READ	User can see the list of users and the list of roles in the system.
Create and Edit Users and Roles	SUITE_USER_ROLE_CREATEANDEDIT	User can create and edit a user, and create and edit a role.
Activate and Deactivate User	SUITE_USER_ACTIVATEANDDEACTIVATE	User can activate and deactivate a user.
Delete Role	SUITE_ROLE_DELETE	User can delete existing roles in the system.
System configuration [PC software]		
Registered Instruments	SUITE_SYSTEM_REGISTERINSTRUMENT	User can see list of registered instruments.
Manage Archive	SUITE_SYSTEM_MANAGEARCHIVE	User can edit Archive location, detach Archive, turn on/off and configure automatic archiving.

Audit Trail Configuration

Permission	Technical name	Description
View Audit Trail	SUITE_AUDITTRAIL_READ	User can see the list of Audit Trail events, search for specific event, check details of the event and export it to PDF.
Audit Trail Toggle	SUITE_AUDITTRAIL_TURNONOFF	User can turn on/off the Audit Trail (events tracker).

Document Revision History

Revision	Description
December 2024	Manual content adjusted to Software Release 3.1
October 2024	Corrected all occurrences of "Long Stokes Shift"
September 2024	Manual content adjusted to Software Release 3.0

Trademarks: QIAGEN®, Sample to Insight®, QIAcuity®, QIAgility® (QIAGEN Group); RNaseZap® (Ambion, Inc.); DNA-ExitusPlus™ (AppliChem); EvaGreen® (Biotium, Inc.); Cy® (GE Healthcare); Alexa Fluor® (Life Technologies Corporation); Windows® (Microsoft Corporation); Texas Red® (Molecular Probes, Inc.); Lysetol®, Mikrozid® (Schülke & Mayr GmbH); FAM™, HEX™, ROX™, TAMRA™, VIC® (Thermo Fisher Scientific or its subsidiaries); DECON-QUAT® (Veltek Associates, Inc.). Registered names, trademarks, etc. used in this document, even when not specifically marked as such, are not to be considered unprotected by law.

Dec-2024 HB-2717-010 © 2024 QIAGEN, all rights reserved.

Page left intentionally blank.

Page left intentionally blank.

