

QIAcuity[®]

User Manual



REF

911000, 911020, 911040, 911050



QIAGEN GmbH
QIAGEN Strasse 1, 40724 Hilden, GERMANY

Contents

1	Introduction	7
1.1	About this user manual.....	7
1.2	General information.....	8
1.3	Intended use of the QIAcuity	8
1.4	Requirements for QIAcuity users	9
2	Safety Information	10
2.1	Proper use	10
2.2	Electrical safety	11
2.3	Environment.....	13
2.4	Biological safety.....	13
2.5	Chemicals	14
2.6	Maintenance safety	14
2.7	Radiation safety	15
2.8	Symbols on the QIAcuity	16
3	General Description	17
3.1	QIAcuity principle	17
3.2	External features of QIAcuity.....	19
3.3	Thermal cyclers.....	22
3.4	Optical system	22
4	Installation Procedure	23
4.2	Installation of AC power cord	26
4.3	Unpacking the QIAcuity	26
4.4	Packing the QIAcuity	27
4.5	Installing the QIAcuity	27
4.6	Upgrading QIAcuity Software Suite to new version	35
4.7	Uninstalling the QIAcuity Software Suite.....	44
4.8	Updating the instrument software.....	47
4.9	Establishing a connection between the QIAcuity instrument and the QIAcuity Software Suite	49
4.10	Getting started with the QIAcuity.....	62

5	Operating the QIAcuity Instrument	68
6	Operating the QIAcuity Software Suite	90
	6.1 Getting started	90
	6.2 Concepts of the QIAcuity Software Suite	92
	6.3 Audit trail	129
	6.4 Setting up an experiment.....	139
	6.5 Defining general data	141
	6.6 Setting up templates.....	160
	6.7 Analysis	163
	6.8 Reports.....	229
	6.9 Sign report	233
	6.10 Archive	236
	6.11 Re-analysis of plates after QIAcuity Software Suite version upgrade.....	239
	6.12 Volume Precision Factor (VPF)	240
7	Operating Plates	243
	7.1 QIAcuity Nanoplate 26K 24-well	243
	7.2 QIAcuity Nanoplate 26K 8-well	244
	7.3 QIAcuity Nanoplate 8.5K 24-well	244
	7.4 QIAcuity Nanoplate 8.5K 96-well	244
8	Maintenance Procedures.....	247
	8.1 Cleaning agents.....	247
	8.2 Servicing.....	250
	8.3 Regular maintenance procedure of QIAcuity.....	250
	8.4 Periodic maintenance.....	251
	8.5 Decontaminating the QIAcuity.....	253
	8.6 Regular maintenance procedure for QIAcuity Instrument Software	253
	8.7 Regular maintenance procedure for QIAcuity Software Suite	255
9	Troubleshooting	256
	9.1 General information.....	256
	9.2 Contacting QIAGEN Technical Services.....	256
	9.3 Performing a self-check on the QIAcuity instrument	256

	9.4	Creating a support package with the QIAcuity instrument software.....	257
	9.5	Creating a support package with the QIAcuity Software Suite	261
	9.6	Troubleshooting the instrument and software.....	263
	9.7	Accessing the system status and clearing errors.....	266
10		Glossary	268
11		Appendix A – Technical Data	269
	11.1	Operating conditions	269
	11.2	Transport conditions.....	270
	11.3	Storage conditions.....	270
	11.4	Mechanical data and hardware features.....	270
	11.5	Declaration of conformity	272
	11.6	Waste Electrical and Electronic Equipment (WEEE).....	272
	11.7	California Proposition 65	273
	11.8	Liability Clause.....	273
	11.9	Declaration list of China RoHS (SJT 11364-2014)	273
12		Appendix B – QIAcuity Accessories.....	275
	12.1	Ordering information	275
13		Appendix C – Informations de sécurité	277
	13.1	Utilisation appropriée	277
	13.2	Sécurité électrique	279
	13.3	Environnement	280
	13.4	Sécurité biologique.....	280
	13.5	Produits chimiques.....	281
	13.6	Sécurité de maintenance	282
	13.7	Sécurité contre les rayonnements.....	282
	13.8	Symboles sur le QIAcuity.....	283
14		Appendix D – Sicherheitshinweise.....	284
	14.1	Sachgemäße Handhabung.....	284
	14.2	Schutz vor Stromschlag	286
	14.3	Umgebung.....	287
	14.4	Biologische Sicherheit	288

14.5	Chemikalien	289
14.6	Wartungssicherheit.....	289
14.7	Strahlensicherheit	290
14.8	Symbole auf dem QIAcuity	290
15	Appendix E – User management permissions	291
16	Document Revision History	295

1 Introduction

Thank you for choosing QIAcuity. We are confident it will become an integral part of your laboratory. Before using QIAcuity, it is essential that you read this user manual carefully and pay attention to the safety information. The instructions and safety information in the user manual must be followed to ensure safe operation of the instrument and to maintain the instrument in a safe condition.

1.1 About this user manual

This user manual provides information about QIAcuity in the following sections:

1. Introduction
2. Safety Information
3. General Description
4. Installation Procedures
5. Operating Procedures
6. Maintenance Procedures
7. Troubleshooting
8. Glossary
9. Appendix A – Technical Data
10. Appendix B – QIAcuity Accessories
11. Appendix C – Consignes de sécurité (Safety Information in French)
12. Appendix D – Sicherheitshinweise (Safety Information in German)
13. Appendix E – User management permissions
14. Document Revision History

1.2 General information

1.2.1 Technical assistance

At QIAGEN®, we pride ourselves on the quality and availability of our technical support. Our Technical Services Departments are staffed by experienced scientists with extensive practical and theoretical expertise in molecular biology and the use of QIAGEN products. If you have any questions or experience any difficulties regarding the QIAcuity or QIAGEN products in general, do not hesitate to contact us.

QIAGEN customers are a major source of information regarding advanced or specialized uses of our products. This information is helpful to other scientists as well as to the researchers at QIAGEN. We therefore encourage you to contact us if you have any suggestions about product performance or new applications and techniques.

For technical assistance and more information, please see our Technical Support Center at www.qiagen.com/support/technical-support or call one of the QIAGEN Technical Service Departments or local distributors (see back cover or visit www.qiagen.com).

1.2.2 Policy statement

It is the policy of QIAGEN to improve products as new techniques and components become available. QIAGEN reserves the right to change specifications at any time.

To produce useful and appropriate documentation, we appreciate your comments about this user manual. Please contact QIAGEN Technical Services.

1.3 Intended use of the QIAcuity

QIAcuity systems are designed to determine absolute amounts of target DNA in a sample by using a digital PCR (dPCR) approach.

Digital PCR uses the procedure of end-point PCR, but splits the PCR reaction in many single partitions in which the template is randomly distributed across all available partitions. After PCR, the target molecule is detected by measuring the fluorescence – either of sequence specific DNA probes or of intercalating dyes – in all positive partitions. As the template is distributed randomly, Poisson statistics can be used to calculate the amount of target DNA per valid partition. The total amount of target DNA in all partitions of a well is then calculated by multiplying the amount of target DNA per partition with the number of valid partitions. Calculation of target concentration is determined by referring back to the volume in all analyzable partitions, i.e., partitions which were filled with reactions mix. The total number of filled partitions is identified by a fluorescent dye, present in the reaction mix itself. Absolute quantification by dPCR eliminates the need of standard curves to determine amounts of target DNA in a given sample.

Aside from absolute quantification, the QIAcuity software provides analysis modules for mutation detection, genome editing analysis, copy number variation (CNV), and gene expression analysis.

QIAcuity systems are intended to be used only in combination with QIAGEN kits indicated for use with the QIAcuity systems such as QIAcuity Nanoplates and QIAcuity PCR Reagents for the applications described in the kit handbooks.

If QIAcuity is used with products other than QIAGEN kits or QIAGEN assays designed for dPCR, it is the user's responsibility to validate the performance of such product combination for any particular application.

The QIAcuity system is intended for use by professional users trained in molecular biological techniques and the operation of the QIAcuity system.

The QIAcuity system is intended for molecular biology applications. This product is not intended for the diagnosis, prevention, or treatment of a disease.

1.4 Requirements for QIAcuity users

This table covers the general level of competence and training necessary for transportation, installation, use, maintenance, and servicing of the QIAcuity systems.

Table 1. Requirements for QIAcuity users

Task	Personnel	Training and experience
Delivery	No special requirements	No special requirements
Installation	Laboratory technicians or equivalent	Appropriately trained or experienced personnel familiar with use of computers and automation in general
Routine use (running protocols)	Laboratory technicians or equivalent	Appropriately trained or experienced personnel familiar with use of computers and automation in general
Assay design and validation	Scientist or equivalent	Appropriately trained or experienced personnel familiar with molecular biological techniques
Dust filter replacement	Laboratory technicians or equivalent	Appropriately trained or experienced personnel familiar with use of computers and automation in general
Preventive maintenance	QIAGEN service personnel or service technicians of an authorized agent	Trained and authorized by QIAGEN
Servicing	QIAGEN service personnel or service technicians of an authorized agent	Trained and authorized by QIAGEN

2 Safety Information

Before using the QIAcuity, it is essential that you read this user manual carefully and pay attention to the safety information. The instructions and safety information in the user manual must be followed to ensure safe operation of the instrument and to maintain the instrument in a safe condition.

Note: Translations of the Safety Information in French and German are available in in Appendix C – Informations de sécurité and Appendix D – Sicherheitshinweise.

The following types of safety information appear in this manual.

<p>WARNING</p> 	<p>The term WARNING is used to inform you about situations that could result in personal injury to you or other persons.</p> <p>Details about these circumstances are given in a box like this one.</p>
---	---

<p>CAUTION</p> 	<p>The term CAUTION is used to inform you about situations that could result in damage to the instrument or other equipment.</p> <p>Details about these circumstances are given in a box like this one.</p>
---	---

The advice given in this manual is intended to supplement, not supersede, the normal safety requirements prevailing in the user's country.

2.1 Proper use

<p>WARNING</p> 	<p>Risk of personal injury and material damage [W1]</p> <p>Improper use of the QIAcuity may cause personal injuries or damage to the instrument. The QIAcuity must only be operated by qualified personnel who have been appropriately trained.</p> <p>Servicing of the QIAcuity must only be performed by a QIAGEN Field Service specialist.</p>
---	--

Perform the maintenance as described in the Maintenance Procedures section. QIAGEN charges for repairs that are required due to incorrect maintenance.

<p>WARNING</p> 	<p>Risk of personal injury and material damage [W2]</p> <p>The QIAcuity is too heavy to be lifted by one person. To avoid personal injury or damage to the instrument, do not lift the instrument alone. The bottom plane shall be used for lifting. Do not lift at the touchscreen.</p>
---	---

WARNING 	Risk of personal injury and material damage Do not attempt to move the QIAcuity during operation.	[W3]
---	---	-------------

CAUTION 	Damage to the instrument Avoid spilling water or chemicals onto the QIAcuity. Damage caused by water or chemical spillage will void your warranty.	[C1]
---	--	-------------

In case of emergency, power OFF the QIAcuity at the power switch located in the back of the instrument and unplug the power cord from the power outlet.

CAUTION 	Damage to the instrument Only use QIAcuity-specific consumables with the QIAcuity. Do not use the plates without applied top-seals. Damage caused by use of other consumables will void your warranty.	[C2]
---	--	-------------

CAUTION 	Damage to the instrument Do not drop objects into the instrument when the plate tray is ejected.	[C3]
---	--	-------------

WARNING 	Risk of explosion The QIAcuity is intended for use with reagents and substances supplied with QIAGEN kits or others that are outlined in respective Information for Use. Use of other reagents and substances may lead to fire or explosion.	[W4]
---	--	-------------

CAUTION 	Damage to the instrument Do not stack instruments and do not place items on top of the QIAcuity.	[C4]
---	--	-------------

CAUTION 	Damage to the instrument Do not lean against the touchscreen when it is pulled out.	[C5]
---	---	-------------

2.2 Electrical safety

Note: Disconnect the line power cord from the power outlet before servicing.

WARNING 	<p>Electrical hazard [W5]</p> <p>Any interruption of the protective conductor (earth/ground lead) inside or outside the instrument or disconnection of the protective conductor terminal is likely to make the instrument dangerous.</p> <p>Intentional interruption is prohibited.</p> <p>Lethal voltages inside the instrument</p> <p>When the instrument is connected to line power, terminals may be live and opening covers or removing parts is likely to expose live parts.</p>
---	---

WARNING 	<p>Damage to electronics [W6]</p> <p>Before powering ON the instrument, make sure that the correct supply voltage is used.</p> <p>Use of incorrect supply voltage may damage the electronics.</p> <p>To check the recommended supply voltage, refer to the specifications indicated in the type plate of the instrument.</p>
---	--

WARNING 	<p>Risk of electric shock [W7]</p> <p>Do not open any panels on the QIAcuity.</p> <p>Risk of personal injury and material damage</p> <p>Only perform maintenance that is specifically described in this user manual.</p>
--	---

To ensure satisfactory and safe operation of the QIAcuity, follow these guidelines:

- The line power cord must be connected to a line power outlet that has a protective conductor (earth/ground).
- Do not adjust or replace internal parts of the instrument.
- Do not operate the instrument with any covers or parts removed.
- If liquid has spilled inside the instrument, power OFF the instrument, disconnect it from the power outlet, and contact QIAGEN Technical Services.



If the instrument becomes electrically unsafe, prevent other personnel from operating it, and contact QIAGEN Technical Services.

The instrument may be electrically unsafe when:

- It or the line power cord appears to be damaged.
- It has been stored under unfavorable conditions for a prolonged period.
- It has been subjected to severe transport stresses.
- Liquids come in contact directly with electrical components of the QIAcuity.

2.3 Environment

2.3.1 Operating conditions

<p>WARNING</p> 	<p>Explosive atmosphere [W8]</p> <p>The QIAcuity is not designed for use in an explosive atmosphere.</p>
<p>CAUTION</p> 	<p>Damage to the instrument [C6]</p> <p>Direct sunlight may bleach parts of the instrument and cause damage to plastic parts.</p> <p>The QIAcuity must be located out of direct sunlight.</p>
<p>CAUTION</p> 	<p>Risk of overheating [C7]</p> <p>To ensure proper ventilation, maintain a minimum clearance of 10 cm at the sides and rear of the QIAcuity.</p> <p>Slits and openings that ensure the ventilation of the QIAcuity must not be covered.</p>

2.4 Biological safety

Specimens and reagents containing materials from humans should be treated as potentially infectious. Use safe laboratory procedures as outlined in publications such as Biosafety in Microbiological and Biomedical Laboratories, HHS (www.cdc.gov/labs/BMBL.html).

2.4.1 Samples

Samples may contain infectious agents. You should be aware of the health hazard presented by such agents and should use, store, and dispose of such samples according to the required safety regulations.

<p>WARNING</p> 	<p>Samples containing infectious agents [W9]</p> <p>Some samples used with this instrument may contain infectious agents. Handle such samples with the greatest of care and in accordance with the required safety regulations.</p> <p>Always wear safety glasses, 2 pairs of gloves, and a lab coat.</p> <p>The responsible body (e.g., laboratory manager) must take the necessary precautions to ensure that the surrounding workplace is safe, and that the instrument operators are suitably trained and not exposed to hazardous levels of infectious agents as defined in the applicable Material Safety Data Sheets (MSDSs) or OSHA *, ACGIH†, or COSHH‡ documents.</p> <p>Venting for fumes and disposal of wastes must be in accordance with all national, state, and local health and safety regulations and laws.</p>
---	--

2.5 Chemicals

<p>WARNING</p> 	<p>Hazardous chemicals [W10]</p> <p>Some chemicals used with this instrument may be hazardous or may become hazardous after completion of the protocol run.</p> <p>Always wear safety glasses, gloves, and a lab coat.</p> <p>The responsible body (e.g., laboratory manager) must take the necessary precautions to ensure that the surrounding workplace is safe and that the instrument operators are not exposed to hazardous levels of toxic substances (chemical or biological) as defined in the applicable Safety Data Sheets (SDSs) or OSHA,* ACGIH†, or COSHH‡ documents.</p> <p>Venting for fumes and disposal of wastes must be in accordance with all national, state, and local health and safety regulations and laws.</p>
---	--

2.6 Maintenance safety

<p>WARNING/ CAUTION</p> 	<p>Risk of personal injury and material damage [W11]</p> <p>Only perform maintenance that is specifically described in this user manual.</p>
--	---

* OSHA : Occupational Safety and Health Administration (United States of America).

† ACGIH : American Conference of Government Industrial Hygienists (United States of America).

‡ COSHH : Control of Substances Hazardous to Health (United Kingdom).

WARNING 	Risk of fire [W12] Do not allow cleaning fluid or decontamination agents to come into contact with the electrical parts of the QIAcuity.
---	---





CAUTION 	Damage to the instrument [C8] Do not use bleach, solvents, or reagents containing acids, alkalis, or abrasives to clean the QIAcuity.
---	--

CAUTION 	Damage to the instrument [C9] Do not use spray bottles containing alcohol or disinfectant to clean surfaces of the QIAcuity.
---	---

2.7 Radiation safety

WARNING 	Risk of personal injury [W13] Hazard Level 2 laser light: Do not stare into the light beam when using handheld bar code scanner.
--	---

2.8 Symbols on the QIAcuity

Symbol	Location	Description
	Type plate on the back of the instrument	CE mark for European Conformity
	Type plate on the back of the instrument	UKCA mark for UK Conformity
	Type plate at the back of the instrument	CSA listing mark for Canada and the USA
	Type plate on the back of the instrument	RCM mark for Australia and New Zealand
	Type plate on the back of the instrument	RoHS mark for China (the restriction of the use of certain hazardous substances in electrical and electronic equipment)
	Type plate on the back of the instrument	Waste Electrical and Electronic Equipment (WEEE) mark for Europe
	Type plate on the back of the instrument	Legal manufacturer
	Type plate on the back of the instrument	Consult instructions for use
	Type plate on the back of the instrument	See chapter Safety Information for risks
	Type plate on the back of the instrument	Date of manufacture
	On the drawer	Biological hazard – some samples used with this instrument may contain infectious agents and must be handled with gloves.

3 General Description

The QIAcuity performs a fully automated processing of the QIAcuity Nanoplates, including all necessary steps of plate priming, sealing of partitions, thermocycling, and image analysis. Depending on the plate type, up to 8, 24, or 96 samples per plate can be analyzed. For high sensitivity applications, the QIAcuity Nanoplate 26K 8- or 24-well is available. The number of in parallel processable plates depends on the instrument configuration (One, Four, Eight). The QIAcuity controls all integrated modules, including a robotic gripper for plate handling, a partitioning module, a PCR thermocycler, and a fluorescence imaging module.

Setting up experiments and the analysis of results is done in the stand-alone QIAcuity Software Suite. The Software Suite and instrument software are able to communicate with each other over a direct or a network connection. If the Software Suite is not available in the instrument, setting up an experiment only in the instrument is also possible.

3.1 QIAcuity principle

The QIAcuity is designed as a walk-away instrument that integrates and automates all plate processing steps. Only the plate preparation must be done manually before starting the run. This includes the pipetting of the target reagents and master mix in the input wells of the plate and the closing of the wells with the top-seal. If this preparation is done and the experiment is set up, the plate must be placed in a free plate slot of the instrument tray. By reading the barcode of the plate, the instrument links the plate to the experiment previously defined in the software and after pressing the play button, all further steps are performed fully automated by the instrument.

The following process steps are done sequentially:

Partitioning: In the first module, the microchannels and partitions of the plate are filled with the input volume of the wells. This is done by plunging the pins in the elastic top-seal and the input wells. This creates a peristaltic pressure that pumps the input well liquid into the microchannels and partitions. Subsequently, the connecting channels between the partitions are being closed by a pressure-controlled rolling process (see images hereafter).

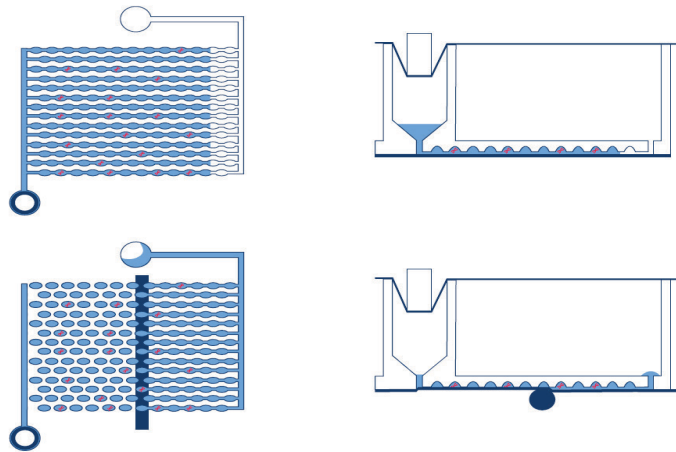

Scheme of filling and partitioning of a well.

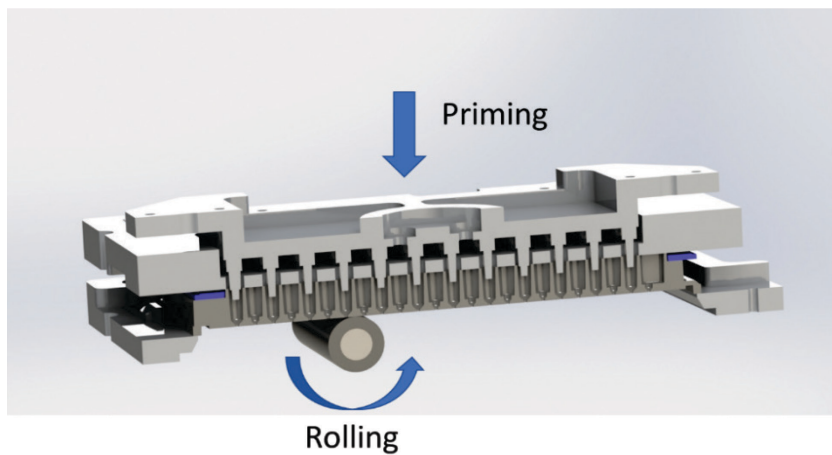

Principle of priming and rolling to allow partitioning of the wells.

Thermocycling: The second step and module is a high-accuracy plate thermocycler that performs the polymerase chain reaction. The cycling profile can be set in the QIAcuity Software Suite or the instrument software. For more details on the thermal cycler specification, see Appendix A – Technical Data.

Imaging: The final process step is the image acquisition of all wells. The user can select the detection channels in the experiment setup. The partitions that have a target molecule inside emit fluorescence light and are brighter than the ones without target (see image hereafter). For more details and specifications on the imaging system, see section Appendix A – Technical Data.

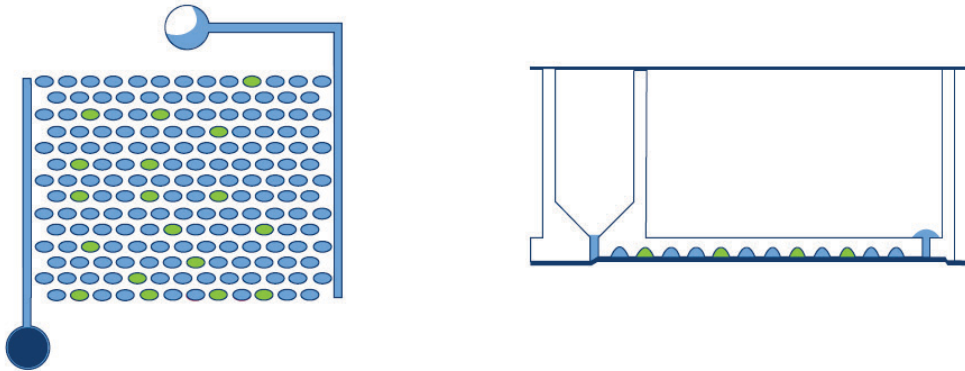

Scheme of positive (green) and negative (blue) partitions after imaging.

3.2 External features of QIAcuity

3.2.1 Touchscreen

The QIAcuity is controlled using a swivel-mounted touchscreen. To adjust the angle of the touchscreen, pull gently at the bottom edge. The touchscreen enables the user to see an overview of all plate slots and the corresponding process steps and remaining times. Additionally, it can be used to extend the plate tray, start/stop plate runs, set up experiments, etc. For all functions and instructions of the instrument software, see *Operating the QIAcuity Instrument*.



Pulled out touchscreen.

Power switch

The main power switch is located at the back of the QIAcuity. To power ON the QIAcuity, turn the power switch to **I** and press the blue soft-switch button at the front of the instrument. The startup screen appears, and the instrument automatically performs initialization tests.

To conserve energy, the QIAcuity can be powered OFF when not in use. To power OFF the QIAcuity, press the blue front soft-switch.

Important: After powering OFF the QIAcuity, wait for a few seconds before switching ON the instrument again. The system might fail to start if you do not allow the QIAcuity to rest for a few seconds before powering ON.

RJ-45 Ethernet port

The RJ-45 Ethernet port is located at the back of the instrument beside the power cord socket. It is only used to connect the QIAcuity to local area network via cable.

USB ports

The QIAcuity has two USB ports that are located at the front of the instrument in the upper left corner. For the QIAcuity Four and Eight, a third slot for accessories is available behind the touchscreen in the upper right corner. To access this slot, extend the touchscreen as far as possible.

The USB ports allow a connection of the QIAcuity to a USB stick. Data files, such as support package, can be transferred via the USB port from the QIAcuity to the USB stick. The USB ports can also be used to plug in an external bar code reader or a mouse/keyboard.

Important: We recommend using QIAGEN USB sticks only to ensure full compatibility.

Important: Do not remove the USB stick while downloading or transferring data or software to or from the instrument.

Power cord socket

The power cord socket is located at the rear right of the QIAcuity and allows connection of the QIAcuity to a power outlet via the supplied power cord.

<p>WARNING</p> 	<p>Electrical hazard [W17]</p> <p>Any interruption of the protective conductor (earth/ground lead) inside or outside the instrument or disconnection of the protective conductor terminal is likely to make the instrument dangerous.</p> <p>Intentional interruption is prohibited.</p> <p>Lethal voltages inside the instrument</p> <p>When the instrument is connected to line power, terminals may be live and opening covers or removing parts is likely to expose live parts.</p>
---	--

<p>WARNING</p> 	<p>Damage to electronics [W18]</p> <p>Before powering ON the instrument, ensure that the correct supply voltage is used.</p> <p>Use of incorrect supply voltage may damage the electronics.</p> <p>To check the recommended supply voltage, refer to the specifications indicated on the type plate of the instrument.</p>
---	--

<p>WARNING</p> 	<p>Risk of electric shock [W19]</p> <p>Do not open any panels on the QIAcuity.</p> <p>Risk of personal injury and material damage</p> <p>Only perform maintenance that is specifically described in this user manual.</p>
--	--

Cooling air outlet

Cooling air outlets are located at the rear side of the QIAcuity and allow cooling of the internal components of the QIAcuity.

<p>CAUTION</p> 	<p>Risk of overheating [C10]</p> <p>To ensure proper ventilation, maintain a minimum clearance of 10 cm at the sides and rear of the QIAcuity.</p> <p>Slits and openings that ensure the ventilation of the QIAcuity must not be covered.</p>
---	---

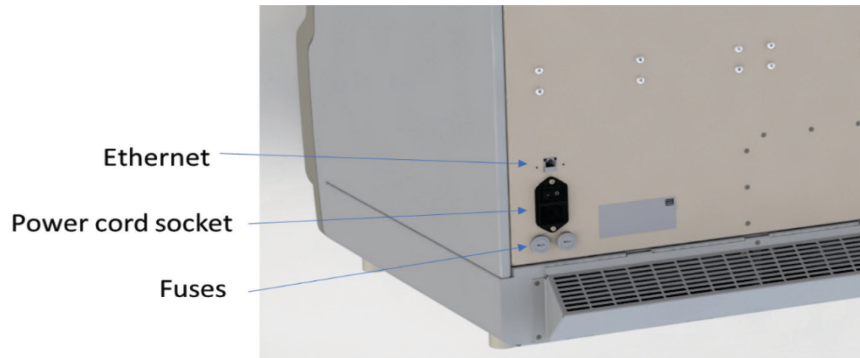

Back view of the QIAcuity.

External hand scanner

The QIAcuity Four and Eight instruments are equipped with a barcode scanner, which enables the user to scan the plate ID before loading. For QIAcuity One, a barcode scanner is available as accessory.

<p>WARNING</p> 	<p>Risk of personal injury [W20]</p> <p>Hazard Level 2 laser light: Do not stare into the light beam when using handheld barcode scanner.</p>
--	--

3.3 Thermal cycler

The thermal cycler of the QIAcuity is a plate thermocycler that features high speed and precision temperature control of the temperature cycling steps. Several Peltier elements are used for the temperature generation and control. For an optimal thermal contact between plate and thermocycler, the plate is being clamped on the heating surface during cycling. The QIAcuity Eight features two thermocyclers that are operated in parallel.

The thermal cycler has the following specification:

Process temperature:	40–99°C
Ramp rate:	approx. 3.0°C/s
Accuracy:	±1°C
Homogeneity:	±1°C

3.4 Optical system

The optical system of the QIAcuity is a camera-based fluorescence microscopy system. The excitation source for the fluorescence dyes is a high-power white LED. This source in combination with a specific excitation filter is used to illuminate a whole well at a time. The fluorophores in the single partitions absorb that light and emit light that is being filtered by a detection filter, collected and imaged through an objective lens on a CMOS-camera chip (see image below for a detailed overview of the components).

Depending on the configuration of the instrument (2plex/5plex), there are up to 2 or 5 selectable detection channels. An additional channel is used for detecting the base fluorescence of the master mix, to determine the exact number of filled partitions and normalization of fluorescence data.

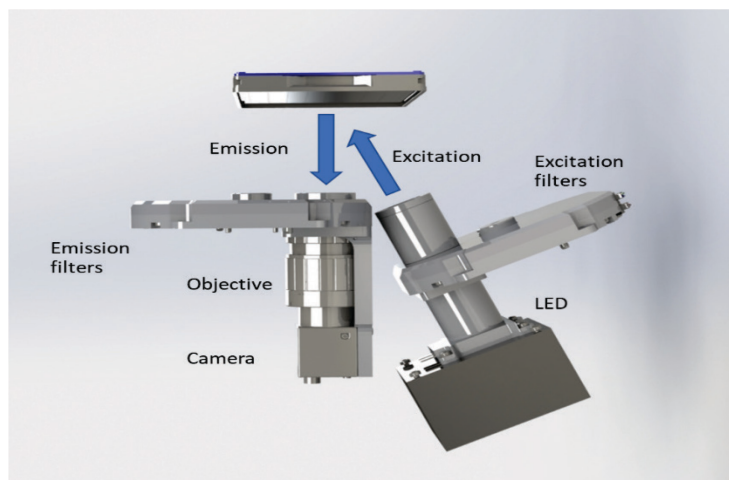

Scheme of the imaging module.

3.4.1 Available channels

Table 2. Available channels in QIAcuity

Channel	Excitation (nm)	Emission (nm)	Example fluorophores
Green	463–503	518–548	FAM™, EvaGreen®
Yellow	514–535	550–564	HEX™, VIC®
Orange	543–565	580–606	TAMRA™
Red	570–596	611–653	ROX™, Texas Red®
Crimson	590–640	654–692	Cy5®

4 Installation Procedure

This section provides instructions on unpacking, packing, and installing the QIAcuity.

The installation procedure of the product is recommended to be carried out by a certified QIAGEN Field Service Specialist. A person who is familiar with the laboratory and computer equipment should be present during the installation.

4.1.1 Site requirements

The QIAcuity must be located away of direct sunlight, away from heat sources, and away from sources of vibration and excessive electrical interference. A vibration amplitude of the lab bench of 6mm/s² shall not be exceeded. Placing a QIAgility[®] instrument or an orbital shaker next to the instrument does not exceed this value. Refer to Appendix A – Technical Data for the operating conditions (temperature and humidity). Be aware that ambient temperatures of below 17°C (63°F) require an equilibration phase of approx. 30–60 min at the location where the instrument will be used before the instrument is powered on. The site of installation should be free of excessive drafts, excessive moisture, and excessive dust and should not be subject to large temperature fluctuations.

Use a level workbench that is large enough and strong enough to accommodate the QIAcuity. Refer to Appendix A – Technical Data for the weight and dimensions of the QIAcuity. Allow at least 10 cm (5.9 in.) of free space behind and to the sides of the instrument for cooling and cabling.

Ensure that the workbench is dry, clean, and vibration-proof and has additional space for accessories.

The QIAcuity must be placed within approximately 1.5 m of a properly grounded (earthed) AC power outlet. The power line to the instrument should be voltage-regulated and surge-protected. Ensure that the QIAcuity is positioned where it is easy to access the power connector and the power switch at the back of the instrument at all times, and that it is easy to power the instrument OFF and disconnect it.

Note: We recommend to plug the instrument directly into its own power outlet and not to share the power outlet with other lab equipment. Do not place the QIAcuity on a vibrating surface or near vibrating objects.

WARNING 	Explosive atmosphere The QIAcuity is not designed for use in an explosive atmosphere.	[W21]
---	---	--------------

CAUTION 	Risk of overheating To ensure proper ventilation, maintain a minimum clearance of 10 cm at the sides and rear of the QIAcuity. Slits and openings that ensure the ventilation of the QIAcuity must not be covered.	[C9]
---	---	-------------

WARNING 	Risk of personal injury and material damage The QIAcuity is too heavy to be lifted by one person. To avoid personal injury or damage to the instrument, do not lift the instrument alone. The bottom plane shall be used for lifting. Do not lift at the touchscreen.	[W2]
---	---	-------------

<p>CAUTION</p> 	<p>Damage to the instrument [C6]</p> <p>Direct sunlight may bleach parts of the instrument and cause damage to plastic parts.</p> <p>The QIAcuity must be located out of direct sunlight.</p>
---	---

4.1.2 Power requirements

The QIAcuity operates at 100–240 V AC, 50/60 Hz, 1500 VA (max.)

Ensure that the voltage rating of the QIAcuity is compatible with the AC voltage available at the installation site. Main supply voltage fluctuations should not exceed 10% of nominal supply voltages.

<p>WARNING</p> 	<p>Damage to electronics [W9]</p> <p>Before powering ON the instrument, make sure that the correct supply voltage is used.</p> <p>Use of incorrect supply voltage may damage the electronics.</p> <p>To check the recommended supply voltage, refer to the specifications indicated in the type plate of the instrument.</p>
---	--

<p>WARNING</p> 	<p>Electrical hazard [W8]</p> <p>Any interruption of the protective conductor (earth/ground lead) inside or outside the instrument or disconnection of the protective conductor terminal is likely to make the instrument dangerous.</p> <p>Intentional interruption is prohibited.</p> <p>Lethal voltages inside the instrument</p> <p>When the instrument is connected to line power, terminals may be live and opening covers or removing parts is likely to expose live parts.</p>
---	---

4.1.3 Grounding requirements

To protect operating personnel, the National Electrical Manufacturers' Association (NEMA) recommends that the QIAcuity be correctly grounded (earthed). The instrument is equipped with a 3-conductor AC power cord that, when connected to an appropriate AC power outlet, grounds (earths) the instrument. To preserve this protection feature, do not operate the instrument from an AC power outlet that has no ground (earth) connection.

<p>WARNING</p> 	<p>Electrical hazard [W8]</p> <p>Any interruption of the protective conductor (earth/ground lead) inside or outside the instrument or disconnection of the protective conductor terminal is likely to make the instrument dangerous.</p> <p>Intentional interruption is prohibited.</p> <p>Lethal voltages inside the instrument</p> <p>When the instrument is connected to line power, terminals may be live and opening covers or removing parts is likely to expose live parts.</p>
---	---

4.2 Installation of AC power cord

The AC power cord connects to the socket located at the rear of the QIAcuity, and the other end to the AC power outlet.

4.3 Unpacking the QIAcuity

<p>WARNING</p> 	<p>Risk of personal injury and material damage [W2]</p> <p>The QIAcuity is too heavy to be lifted by one person. To avoid personal injury or damage to the instrument, do not lift the instrument alone. The bottom plane shall be used for lifting. Do not lift at the touchscreen.</p>
--	--

Note: Before unpacking the QIAcuity, move the package to the site of installation and check that the arrows on the package point upward. In addition, check whether the package is damaged. In case of damage, stop here and contact QIAGEN Technical Services.

1. Cut the straps securing the packaging to the shipping pallet.
2. Open the top of the transportation box to remove the accessories set before lifting the box.
3. Remove the top and side protective black foam.
4. When lifting the QIAcuity, we recommend to utilize a minimum of two people. Lift the instrument by sliding your hands under both sides of the workstation and keeping your back straight.
5. **Important:** Do not hold the touchscreen display while unpacking or lifting the QIAcuity as it might damage the instrument.
6. Check if the packing list document is included after unpacking the QIAcuity.
7. Read the packing list to check that you have received all items. If anything is missing, contact QIAGEN Technical Services.
8. Check that the QIAcuity is not damaged and that there are no loose parts. If anything is damaged, contact QIAGEN Technical Services. Make sure that the QIAcuity has equilibrated to ambient temperature before operating it.
9. Retain the package in case you need to transport the QIAcuity in the future. Refer to Packing the QIAcuity for more details. Using the original package minimizes the possibility of damage during transportation of the QIAcuity.

4.4 Packing the QIAcuity

WARNING 	Risk of personal injury and material damage [W2] The QIAcuity is too heavy to be lifted by one person. To avoid personal injury or damage to the instrument, do not lift the instrument alone. The bottom plane shall be used for lifting. Do not lift at the touchscreen.
---	---

Note: Before transporting the QIAcuity, the instrument must first be decontaminated. Refer to section Maintenance Procedures for more details. Then, prepare the instrument as follows:

1. Turn off the instrument and unplug the power cord.
2. Re-install the shipping fixation screw.
3. Prepare the packing material. Materials required are the cardboard carton, the pallet with foam blocks, and the foam lid.
4. Place the QIAcuity onto the pallet and put the black foam lid over the top of the instrument. Place the box onto the instrument.

Important: When lifting the QIAcuity, slide your hands under both sides of the instrument and keep your back straight.

Important: Do not hold the touchscreen display while lifting the QIAcuity, as this might damage the instrument.

WARNING 	Risk of personal injury and material damage [W2] The QIAcuity is too heavy to be lifted by one person. To avoid personal injury or damage to the instrument, do not lift the instrument alone.
---	---

5. Place the accessories into the black foam lid.

Important: The power cord must be packed in an air cushion bags.

6. Seal the outside edges of the carton with tape to protect against moisture.

Note: Using the original package minimizes potential damage during transportation of the QIAcuity.

4.5 Installing the QIAcuity

This section describes important actions that must be performed before operating the QIAcuity. These actions include:

- Removal of the protective film from the QIAcuity touchscreen
- Removal of the shipping fixation screw
- Connection of the power cord to the back of the QIAcuity
- Powering ON the QIAcuity
- Removal of protective foam block of the drawer

4.5.1 Removing the protective film from the QIAcuity touchscreen

Carefully peel off the protective film from the QIAcuity touchscreen.

4.5.2 Removing the shipping fixation screw

Access the back of the instrument and remove the shipping fixation screw using a 4 mm hex wrench. Store the fixation screw on a safe place in case it is needed at a later point in time. The hole in the housing for the fixation screw shall be closed with the dust cap that is provided with the accessories of the instrument (cat. no. 9026772).



Back of QIAcuity.

4.5.3 Connecting the power cord to the back of the QIAcuity

1. Remove the power cord from the foam packing material on top of the QIAcuity.
Note: Only use the power cord that is supplied with the QIAcuity.
2. Check that the voltage rating on the label found at the back of the QIAcuity matches the voltage available at the installation site.
3. Connect the power cord to the power inlet of the instrument and connect the cable to the wall power outlet.
4. Turn on the power switch at the back of the instrument.

<p>WARNING</p> 	<p>Damage to electronics [W9]</p> <p>Before powering ON the instrument, make sure that the correct supply voltage is used.</p> <p>Use of incorrect supply voltage may damage the electronics.</p> <p>To check the recommended supply voltage, refer to the specifications indicated in the type plate of the instrument.</p>
---	--

<p>WARNING</p> 	<p>Electrical hazard</p> <p>Any interruption of the protective conductor (earth/ground lead) inside or outside the instrument or disconnection of the protective conductor terminal is likely to make the instrument dangerous. Intentional interruption is prohibited.</p> <p>Lethal voltages inside the instrument</p> <p>When the instrument is connected to line power, terminals may be live and opening covers or removing parts is likely to expose live parts.</p>	<p>[W8]</p>
---	--	--------------------

4.5.4 Powering ON the QIAcuity

Check that the QIAcuity operates properly:

1. Ensure that the drawer of the QIAcuity is closed.
2. Power ON the QIAcuity using the blue front power switch.
3. The startup screen appears. The instrument automatically performs initialization tests.

Note: The main power switch in the back must be switched on as well.

Note: If ambient temperature is below 17°C (63°F), an equilibration phase of 30–60 min might be required. After the equilibration phase, the error can be cleared and the instrument is operational after restart.

4. If there is an initialization error, retry the initialization process by turning the instrument off and on again. If the problem persists, see Troubleshooting the instrument and software or contact QIAGEN Technical Services.

Note: The instrument must be turned off at least once a week.

4.5.5 Removal of protective foam block of the drawer

Open the drawer of the QIAcuity instrument by pressing the physical button on the instrument or tapping **Eject Tray** on the instrument and remove the protective foam. For QIAcuity Eight instrument, remove the foam of both drawers.

4.5.6 Installing a fresh copy of the QIAcuity Software Suite

Visit www.qiagen.com and go to the Software section of the QIAcuity product page to check if an updated software version is available for download.

The QIAcuity Software Suite is designed to work with Windows® 10 operating system. The following browsers were tested in the QIAcuity Software Suite:

- Mozilla Firefox: version 106.0.1
- Microsoft Edge: version 106.0.1370.52

- Google Chrome: version 106.0.5249.119

The QIAcuity Four and Eight instruments are supplied with a notebook; the QIAcuity One instrument can be optionally supplied with a notebook. See the following table for the recommended notebook requirements.

Table 3. Recommended notebook requirements

Description	Recommended requirement
Operating system	Microsoft® Windows 10 Professional Edition 64-bit version
Processor	x64 compatible processor with 4 physical cores and 2.5 GHz
Main memory	16 GB RAM
Hard disk space	At least 500 GB
Graphics interface	At least 1920 x 1080 pixels

Note: The QIAcuity Software Suite was tested on latest available Windows 10 update. Later updates should not cause any malfunctioning; however, we recommend to consider only critical security updates.

Note: We are monitoring Windows 10 security update compatibility and browser updates with our QIAcuity Software Suite application on a regular basis. So far we have not detected an update that lead to failure of our Software Suite Application Service. We will continue to monitor security updates and will inform you in case of any issue we might see in future.

The QIAcuity Software was developed and tested for use on Windows 10. Other operating systems were not officially tested, but preliminary tests indicate that the current QIAcuity Software Suite may be operated on Windows 11 without any loss of functionality. However, if you are in doubt, please refrain from operating systems other than the officially recommended version.

Note: The firewall settings are handled by the Software Suite installer for a proper work of software. We recommend to not change any firewall settings after Software Suite installation.

Note: The QIAcuity Software Suite was tested with disabled Microsoft Windows Defender Antivirus.

The QIAcuitySoftwareSuite.exe package needed for the installation of the QIAcuity Software Suite is provided on the USB drive that comes with the QIAcuity. Alternatively, you can download the QIAcuitySoftwareSuite.exe package from www.qiagen.com.

Before starting the installation process using the QIAcuity Setup Wizard, please note the following important setup information:

1. Ensure that the system data and time of the laptop to be used are up to date.
2. Turn off the standby/hibernation settings in the Windows configuration.
 - 2a. Right-click Windows start menu and select **Power Options**.
 - 2b. Click change plan settings next to your current power plan.
 - 2c. Select Never in the Put the computer to sleep field.

- 2d. Click Save changes.
- 2e. Go to Advanced Settings > Sleep.
- 2f. Set the **Hybrid sleep** field to **Off**.
- 2g. Click **Apply**.
- 2h. Please attach the computer via cable to your local network or connect it to the QIAcuity directly, depending on your preferred setup.

Note: If you will choose a direct setup, it is recommended to set the Network adapter settings described in section Establishing a connection between the QIAcuity instrument and the QIAcuity Software Suite before continuing with Suite installation.

Note: Please do not use any USB network adapter in addition to the ethernet cable connected to the instrument or to the laptop.

- 2i. It is recommended to switch off the password expiration on the Suite laptop.
3. Ensure that the following port is opened (on notebook and network):

- The inbound TCP port 8080

Note: It is possible to install the QIAcuity Software Suite as a standalone application without any connection to the instruments (network or direct). After successful installation of the Software Suite, the software application can be used without an ethernet connection.

To install the QIAcuity Software Suite on the notebook, follow the steps below.

1. Locate the QIAcuitySoftwareSuite.exe file and double-click it. The installation process starts.
2. Check the **I accept the terms in the License Agreement** box in the End-User License Agreement window and click **Install**.

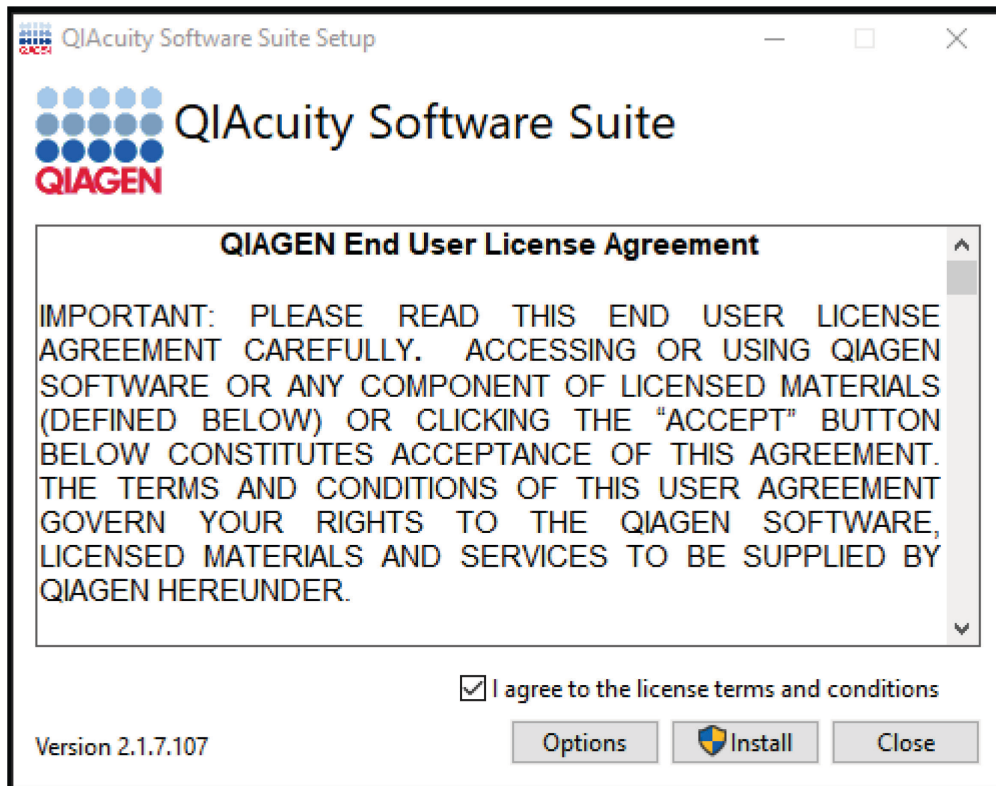

3. In the prompt window asking you if you allow changes to your device, click **Yes**.

Note: During installation, some command line windows may appear in the foreground. Do not close any of them.

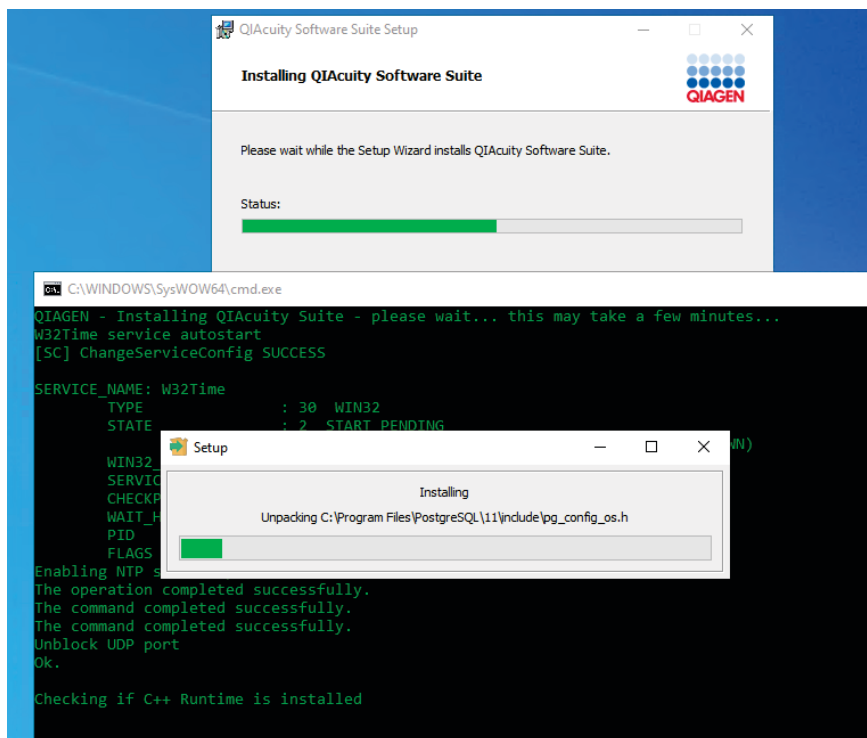

4. When the installation is completed, click **Close**.

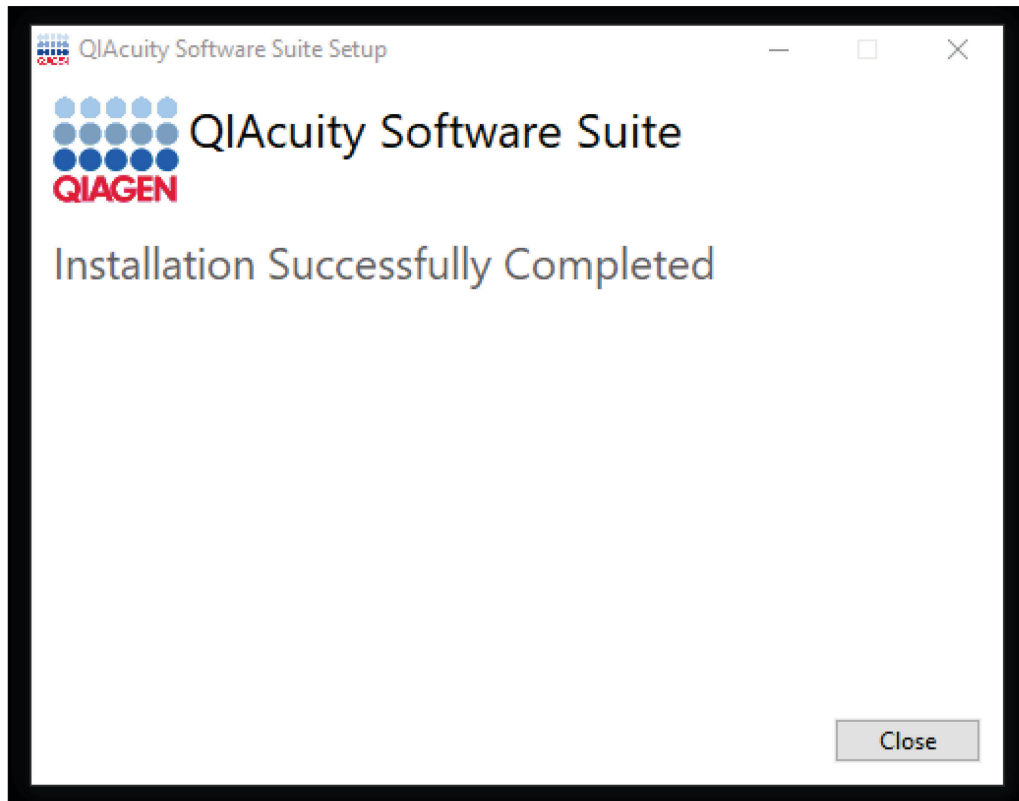

5. In the local host site that says the site is not secure, click **Advanced**.

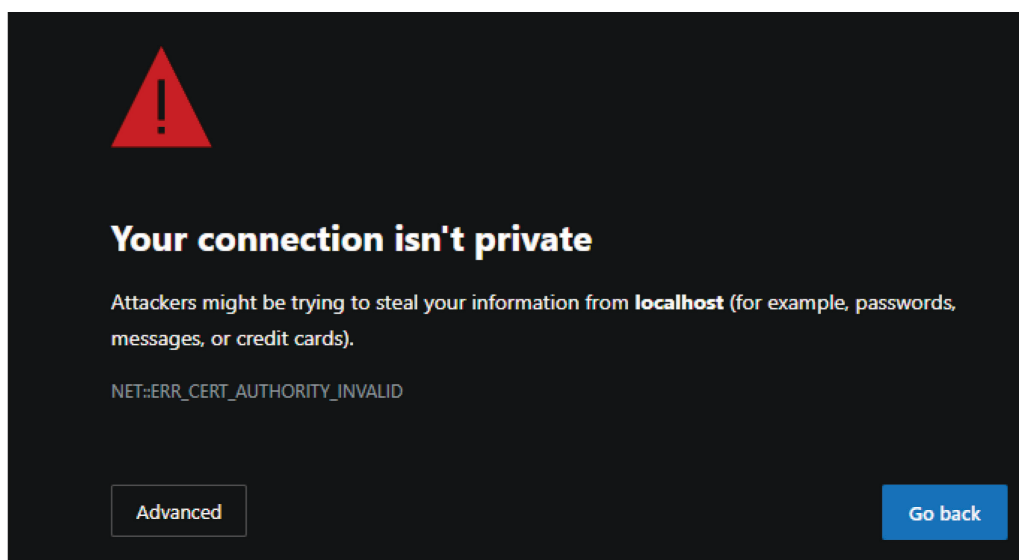

6. Click **Continue to localhost** on to the webpage.

7. You are directed to the QIAcuity Software Suite login screen.

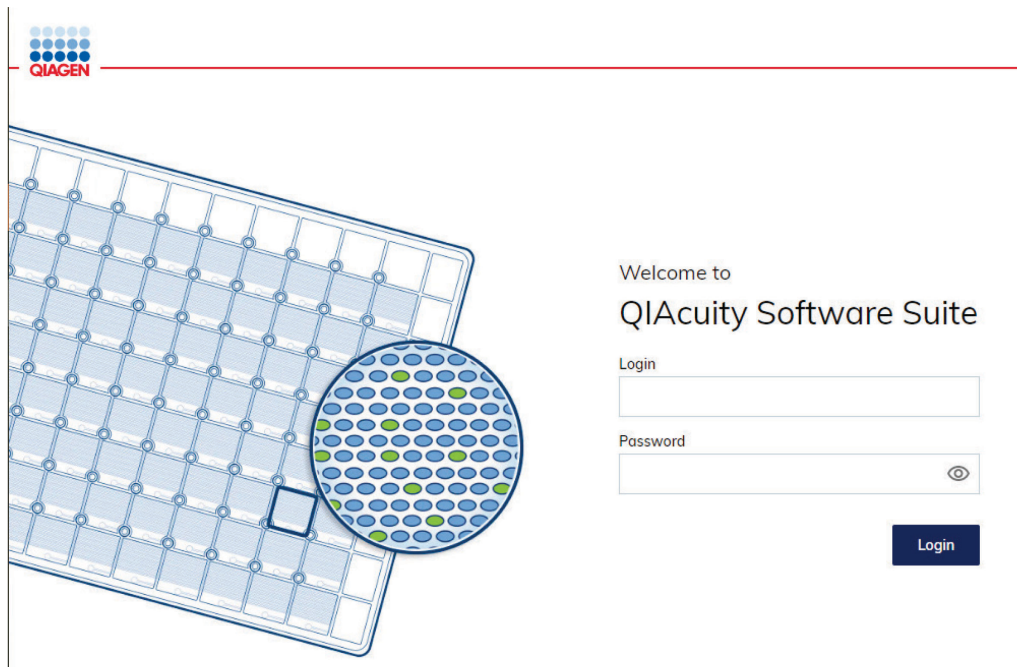

4.6 Upgrading QIAcuity Software Suite to new version

The latest Software Suite version 2.1 is only compatible with the control software version 2.1. If only one software component is updated, no connection between the Software Suite and the control software can be established.

Important: It is strongly recommended to update the Software Suite first before proceeding with the control software.

Important: Upgrading to the QIAcuity Software Suite 2.1 should be performed without uninstallation of the previously installed QIAcuity Software Suite version 2.1. Please continue with steps described in page 38 on how to upgrade the QIAcuity Software Suite 1.2 or 2.0. We support following upgrade scenarios:

- From 1.2 directly to 2.1
- From 2.0 to 2.1

Note: All older versions than Software Suite version 1.2.18 are not supported for a direct upgrade to 2.1 (in case if update from 1.1.3 to newer version is required please follow section “Updating QIAcuity Software Suite 1.1.3 to 1.2.18”).

Note: For software upgrade from Software Suite version 2.0 to 2.1, please ensure that each user has assigned only one role in the system. Otherwise, it may cause an error in the User Management after the software upgrade to version 2.1.

Note: Before updating the QIAcuity Suite software to version 2.1, please make sure that the system data and time of the laptop to be used are up to date. Be sure to set the Time Zone in Windows first, and then adjust the date and time, if needed. If an adjustment is required, please restart your QIAcuity Suite application followed by Control Software before proceeding with the software update.

The QIAcuity Software Suite 2.1 automatically creates a data backup during the upgrade process, if this option was not deselected by the user during the upgrade (you need to click "Options" to see checkbox). The backup folder will be created on **C:\qiacuity_backup_<ddMMyyyyHHmmss>**. The last part of above path is a timestamp which will allow the user to differentiate backups. Please make sure that there is enough free space on your hard drive C:\. You can use Disk Space tool from the Software Suite to monitor available space or directly check in Windows Explorer how much space your installation already takes – you need at least the same amount of space for backup as the amount of space for installation. Otherwise, in case of not enough disc space during upgrade you will encounter an unidentified error – please refer to chapter: "Troubleshooting the instrument and software" for more details.

Note: Backup will be done only in the upgrade phase, so no backup will be created when uninstalling, repairing, or installing a fresh Suite. The checkbox will be visible (in "Options" menu) also during the fresh installation, however it has no impact on the backup process.

To restore from backup, navigate to the folder with the backup and run "flash-rollback.bat", then follow instructions from the pop-up window.

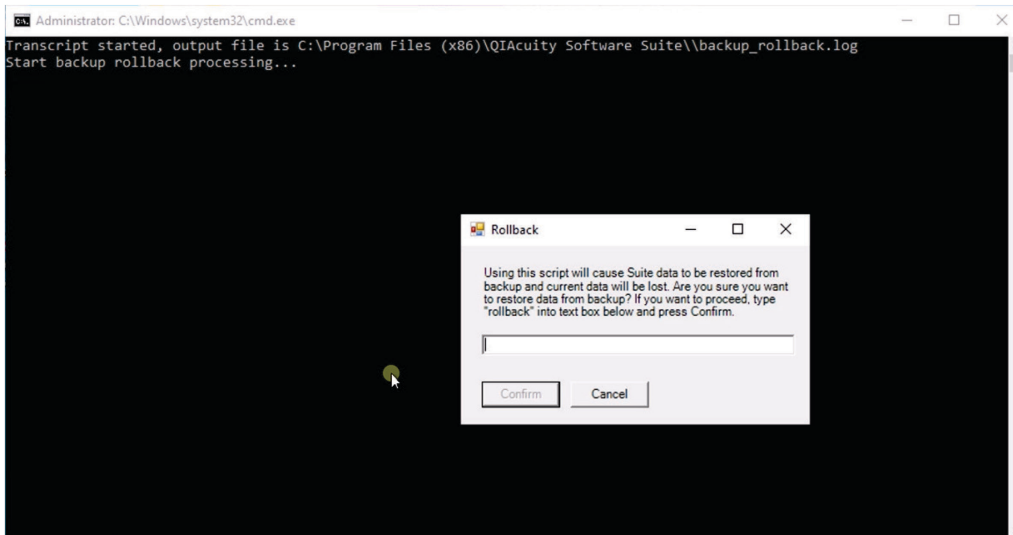
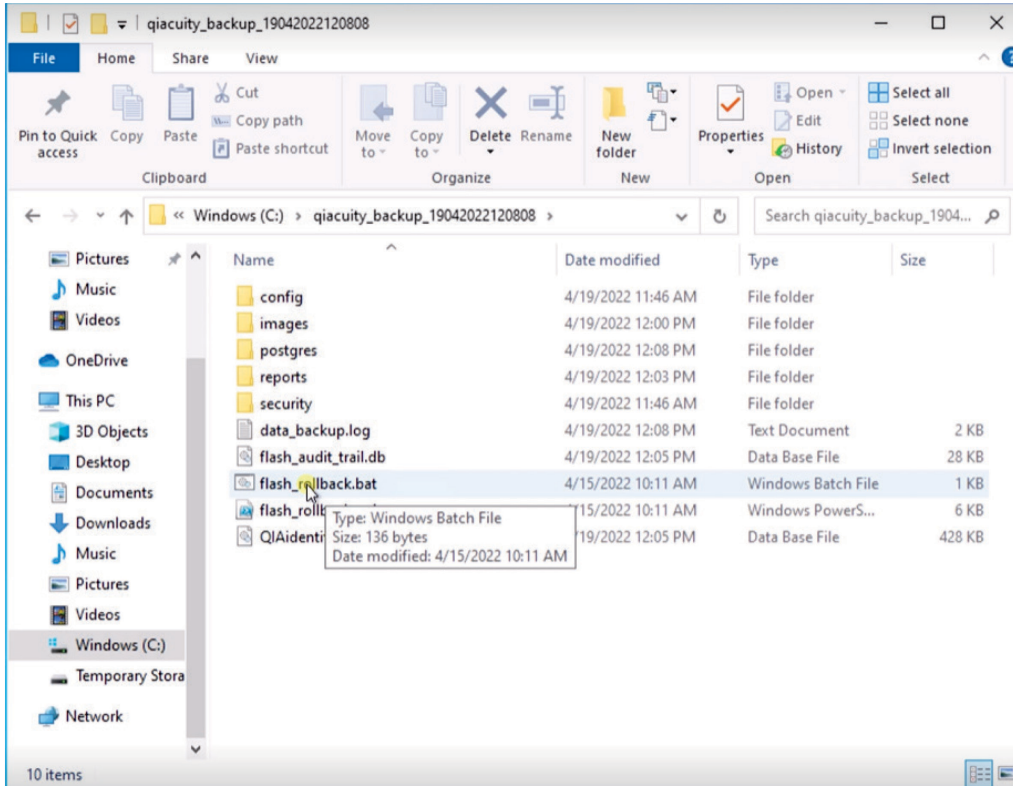

4.6.1 Updating QIAcuity Software Suite 1.2 or 2.0

To upgrade the QIAcuity Software Suite 1.2 or 2.0 to the newest version, follow the steps below.

1. Locate the QIAcuitySuite.exe file and double-click it. The installation process starts. Click **Next**.

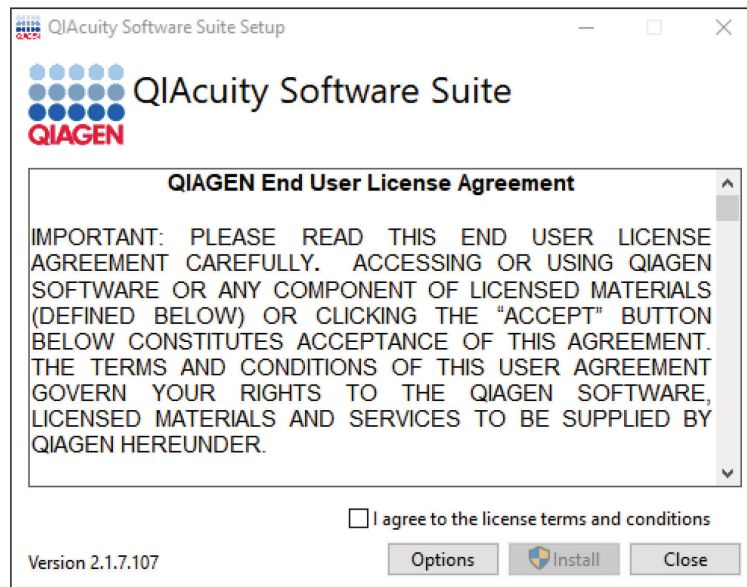

2. Check the **I accept the terms in the License Agreement** box in the End-User License Agreement window and click **Install**.

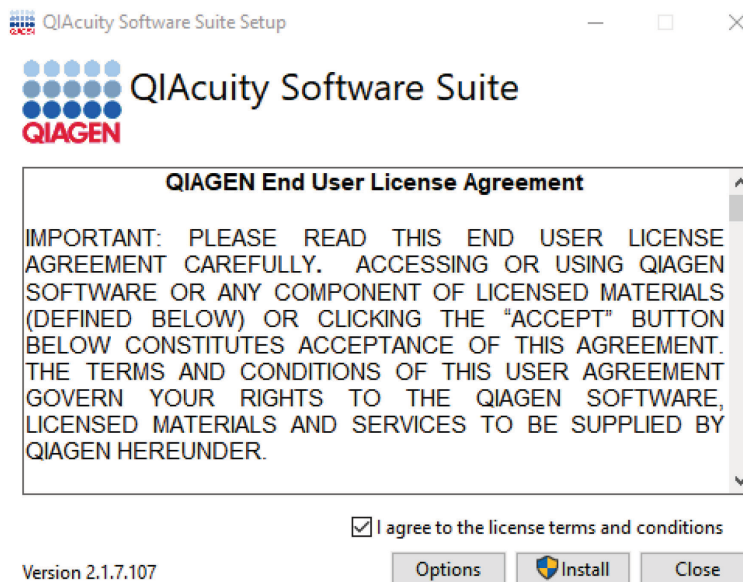

3. In the prompt window asking you if you allow changes to your device, click **Yes**.
4. The system will then automatically upgrade the existing installation.
5. When the installation is completed, click **Finish**.

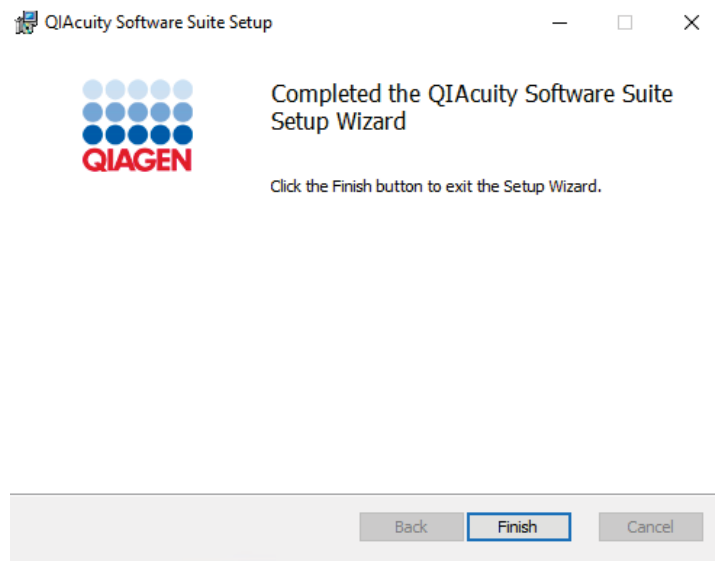

6. Please note that the computer must be restarted after successful Suite upgrade. You will receive the following message:

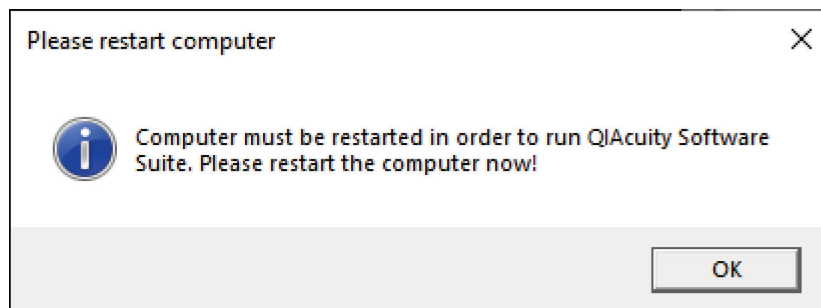

7. Click **OK**.

8. Then, click **Restart** and the computer will begin to restart.

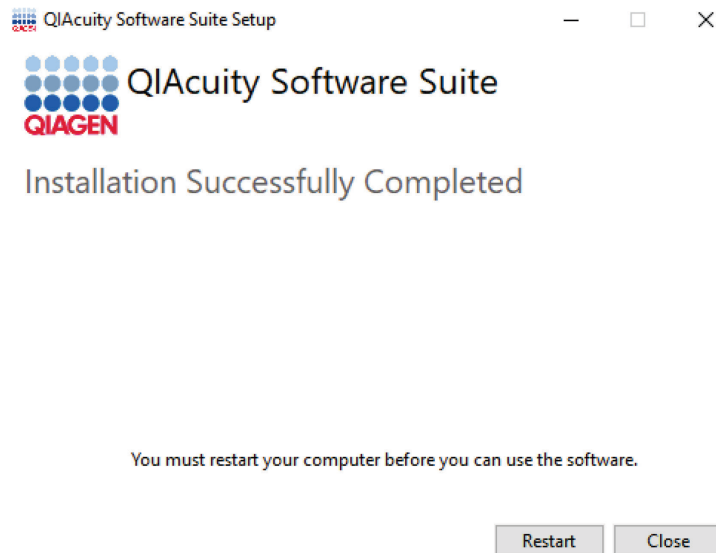

4.6.2 Updating QIAcuity Software Suite 1.1.3 to 1.2.18

This chapter describes the protocol for the update of the QIAcuity Software Suite 1.1.3 to 2.1 and Control Software 0.5.2.18 to 2.1.

Note: The Software Suite 1.1.3 cannot be updated directly to version 2.1 but has to be updated to version 1.2.18 first.

To upgrade the QIAcuity Software Suite version 1.1.3 to the newest version, follow the steps below:

1. Import all plates from QIAcuity Software Suite 1.1.3, and ensure they are visible in the plate overview.

Note: Plates from the QIAcuity Software Suite 1.1.3 need to be updated together with the software suite update. Plates created with the QIAcuity Software Suite 1.1.3 cannot be imported into the QIAcuity Software Suite 1.2.18 or newer, separately.

2. Ensure that a direct connection or a connection via network is already established and that the instrument and the PC running the QIAcuity Software Suite 1.1.3 are connected.

3. Locate the QIAcuitySuite.msi file and double-click it. The installation process starts. Click **Next**.

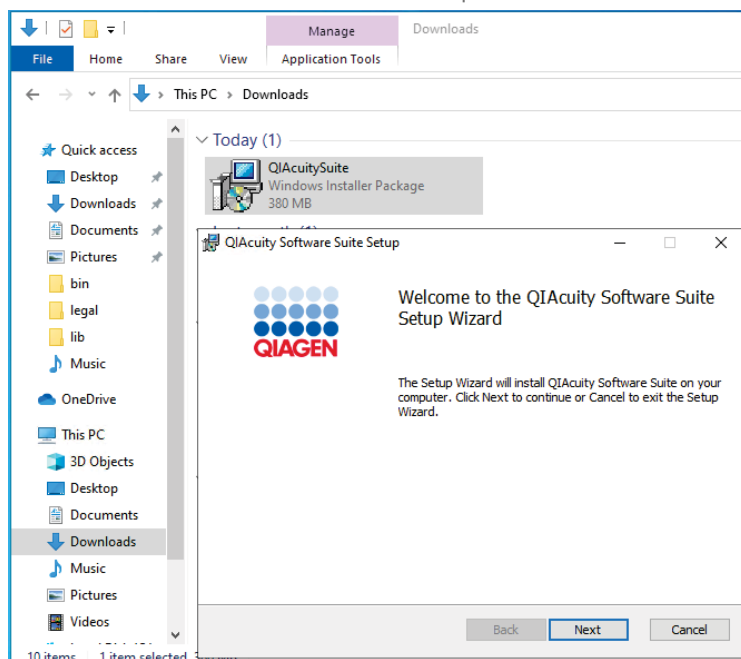

4. Check the **I accept the terms in the License Agreement** box in the End-User License Agreement window and click **Next**.

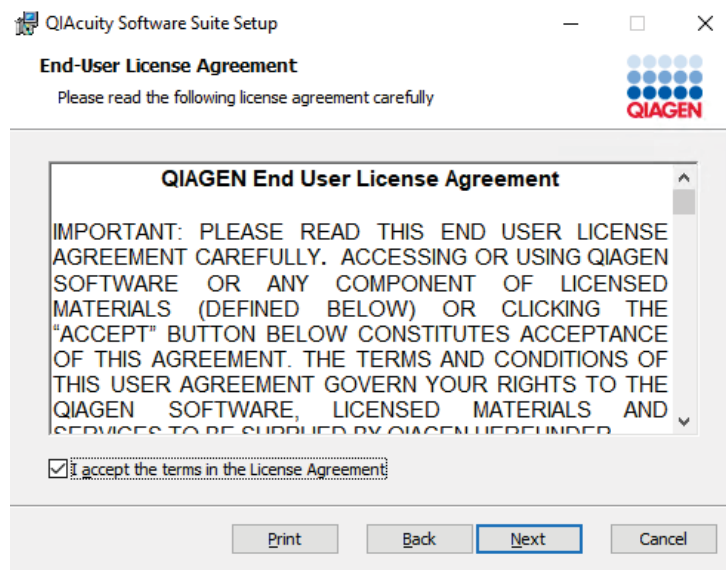

5. Please make sure that the Destination Folder points to the existing installation of the QIAcuity Software Suite. Click **Next** in the Destination Folder window.

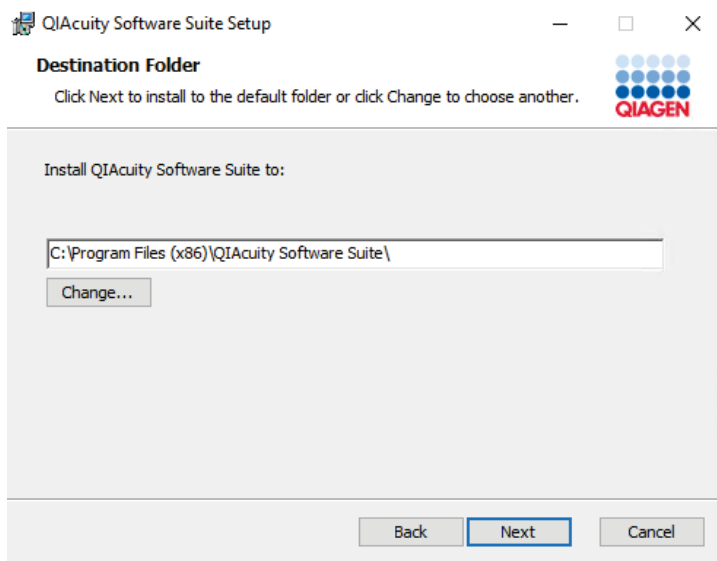

6. Click **Install** to start the installation.

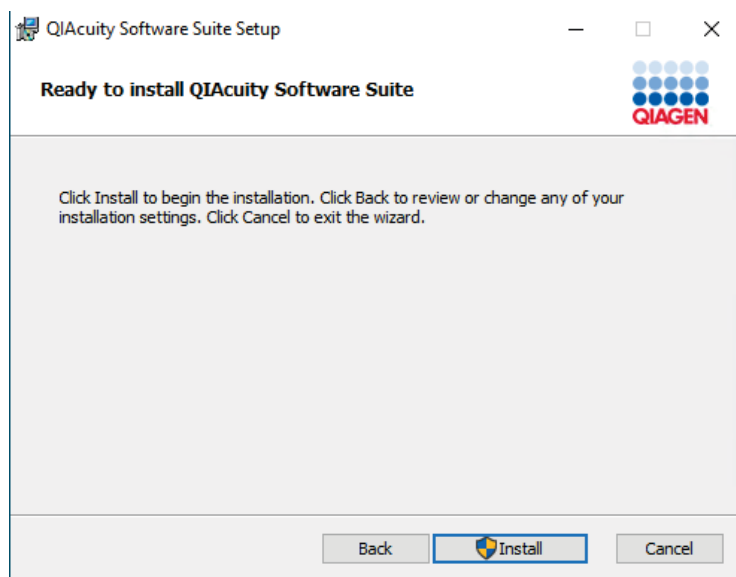

7. In the prompt window asking if changes are allowed to the device, click **Yes**.

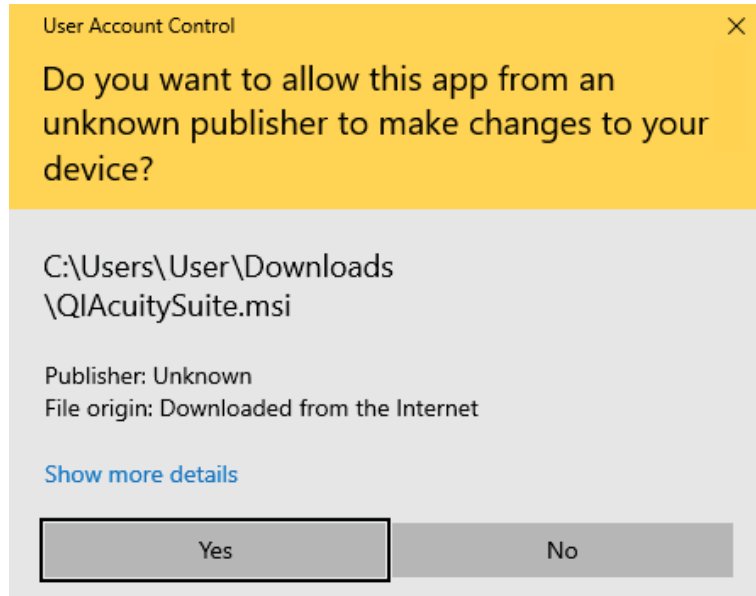

The system will then automatically upgrade the existing installation.

8. When the installation is completed, click **Finish**.

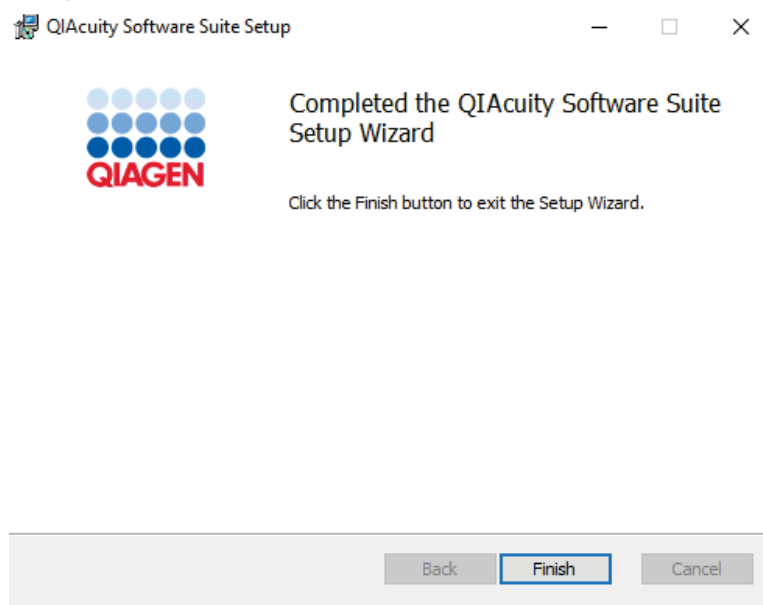

9. Update QIAcuity Suite as outlined in section "Updating QIAcuity Software Suite 1.2 or 2.0", on page 38.

10. Update QIAcuity instrument software as outlined in section "Updating the instrument software", page 47.

4.7 Uninstalling the QIAcuity Software Suite

To uninstall the QIAcuity Software Suite from your system, follow the steps below. Please note that this will lead to loss of all data including plate runs.

1. Go to the **Control Panel** app.

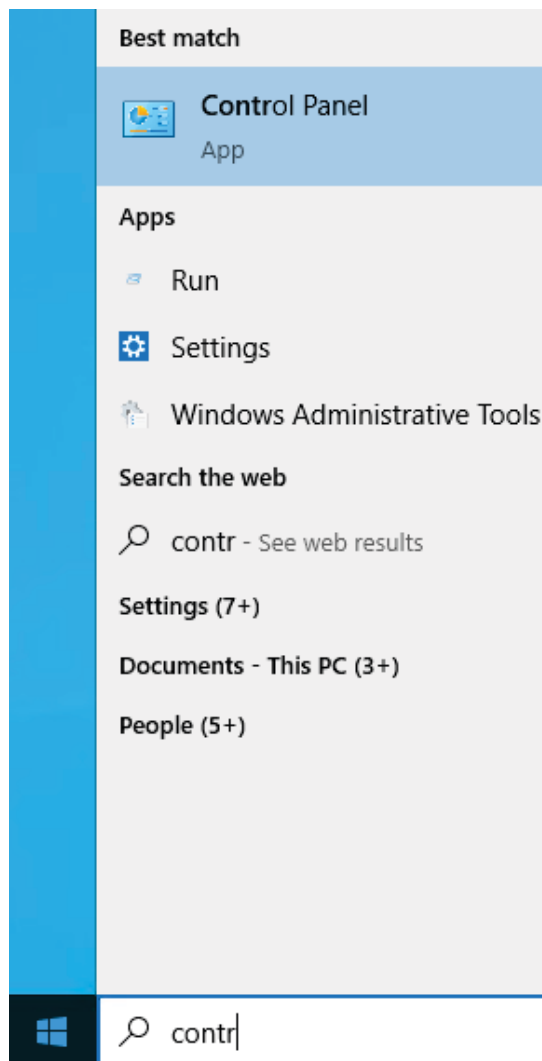

2. Select **Uninstall a program** from the Programs menu.

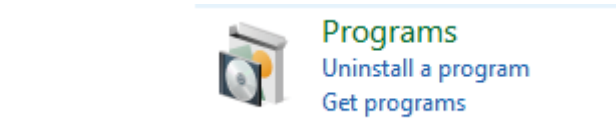

3. Select **QIAcuity Software Suite** from the list, and click **Uninstall**.

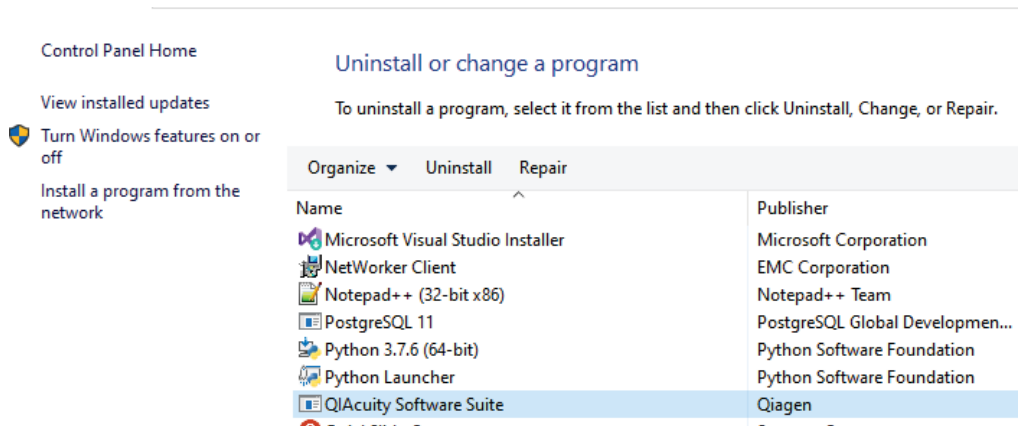

4. In the prompt window asking you if you allow changes to your device, click **Yes**.

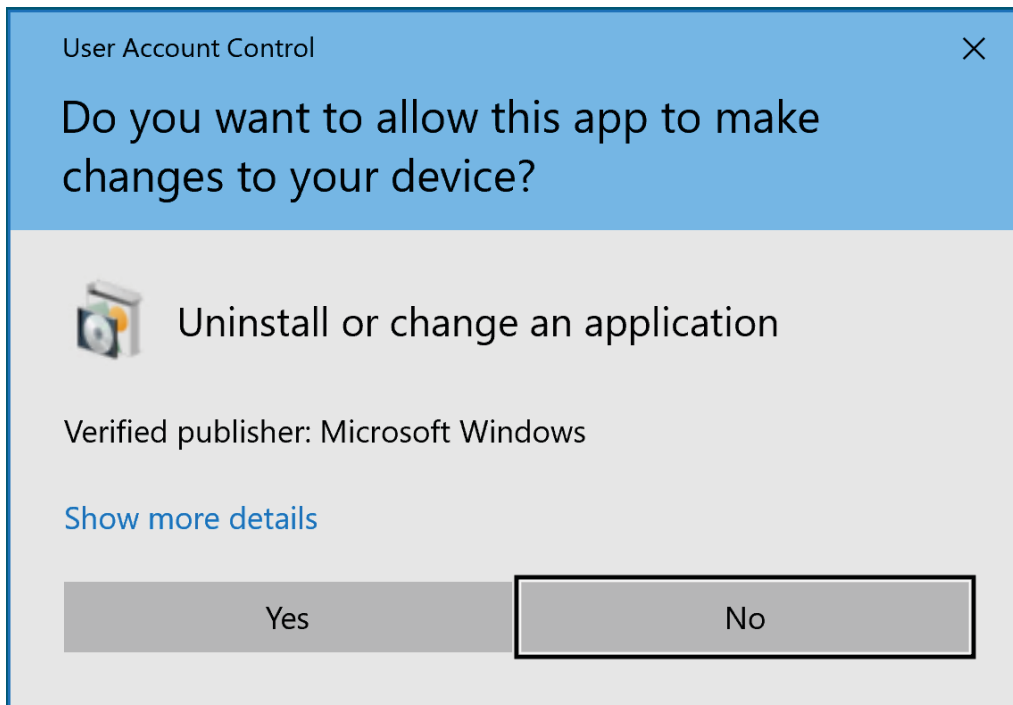

5. In the uninstallation wizard, read the description for each action.

Note: The uninstall process will result in database deletion; all plate data will be lost.

6. Click the **Uninstall and delete** button, and the QIAcuity Software Suite uninstallation process will start.

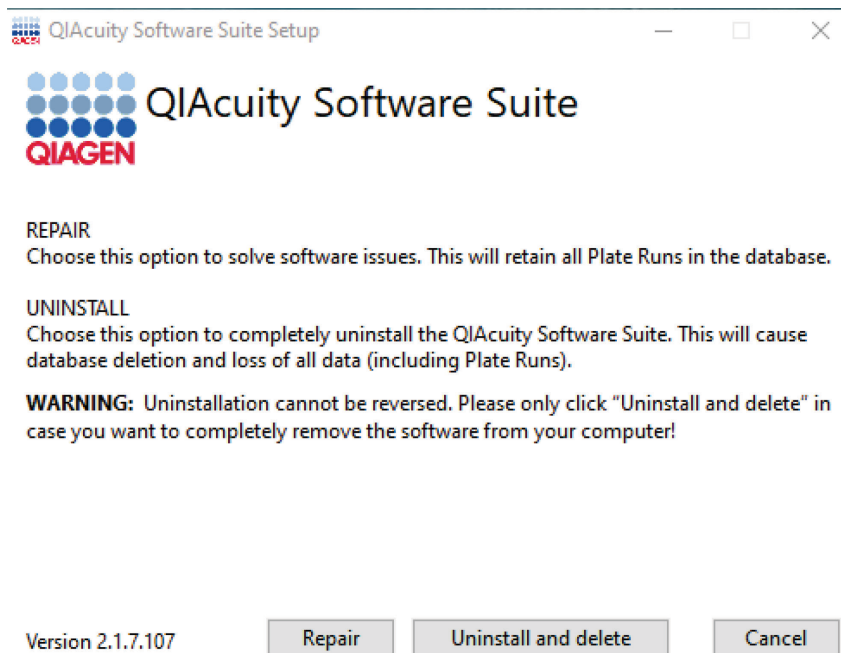

7. After uninstallation, click **Restart** in the window asking to restart the device.

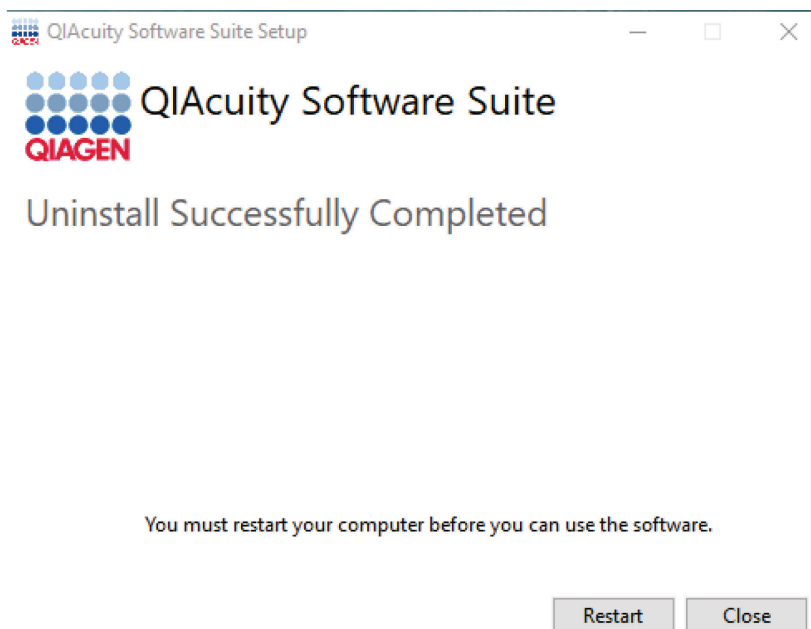

Note: After uninstalling the Software Suite, the User database remains on the computer preinstalled. To remove it, go to **C:\ProgramData\Qiagen** and remove the **\Qiaidentity** directory manually. Be aware that **\ProgramData** might be hidden and you need to change the view settings of the explorer. Please also manually delete the remaining PostgreSQL, which is located at **C:\Program Files\PostgreSQL**.

4.8 Updating the instrument software

Note: The latest Software Suite version 2.1 is only compatible with the latest control software version 2.1. If only one software component is updated, no connection between the Software Suite and the control software can be established.

Important: It is strongly recommended to update the Software Suite first before proceeding with the control software.

An direct update from CSW 1.0.0.84 and CSW 2.0.0.144 to CSW 2.1 software version is possible. Update from CSW 0.5.2.18 to CSW 2.1 requires updating to CSW 1.0.0.84 or CSW 2.0.0.144 first. Direct update from CSW version 1.0.0.84 to 2.1 may require an additional restart of the instrument to migrate users.

Visit www.qiagen.com and go to the Software section of the QIAcuity product page to check if an updated software version is available for download.

Note: Only users with an Administrator and Lab Leader role can perform software updates.

On a computer running Microsoft Windows, download the software update from www.qiagen.com. Insert the USB drive provided with the QIAcuity, create a new folder named **update**, and extract the update software into this folder.

It is recommended to clear the data first by clicking **Force clear** in Data Management under **Tools** before the update.

1. On the Home screen, tap **Configuration**.
2. Select the System tab.
Note: The current software and firmware version are located in the Device Info pane.
3. Connect the USB drive to the instrument.
4. The software version of the update package on the USB is displayed in the Update Info (USB) panel.
Note: If the USB drive is empty, no information is displayed in the Device Info (USB) panel.
5. Tap **Update software** to proceed.
6. The Update Flash Controller Software and Firmware window is shown.
7. Tap **Start** to begin the software update or tap **Cancel** to return to the previous window.
8. The update files are copied from the USB drive to the instrument's internal drive. The status of the file copying process is shown on the screen.
Note: If an error occurs when the files are being copied, an error message is shown on the screen. Tap **Cancel** to stop the process. Remove the USB drive and tap **Reboot** to restart the instrument. If the QIAcuity does not function after an unsuccessful software update, contact QIAGEN Technical Services.
9. After the software update files are copied, tap **Reboot** to restart the instrument.
10. The QIAcuity restarts and installs the software firmware update, which can take up to 1 hour.
11. **Important:** In case of update from instrument software 1.0.0.84 to 2.1 a second restart is required to be able to log in.
12. **After the final restart of the instrument, the network icon and the Software Suite icon should be green and you may login with the admin credentials previously defined in the QIAcuity Software Suite.**
 - 12a. If the Software Suite is not yet connected, login in with the SetupUser credentials.
 - 12b. Check your Software Suite settings. If all settings are done properly, press Test Connection and Save.
 - 12c. Once the Software Suite is detected, a pop-up will state that a new Software Suite was detected and a restart is needed.
 - 12d. Restart the instrument.
 - 12e. After restarting the instrument, the connection between to the Software Suite is established and you may login with the admin credentials previously defined in the QIAcuity Software Suite.

4.9 Establishing a connection between the QIAcuity instrument and the QIAcuity Software Suite

The QIAcuity instrument needs to be connected to the QIAcuity Software Suite to enable the exchange of data. This also enables the QIAcuity Software Suite to set up plates, analyze results, and monitor the status of runs in real time. For this, the QIAcuity instrument and the QIAcuity Software Suite may be connected via an Ethernet cable between the QIAcuity and the notebook where the QIAcuity Software Suite is running.

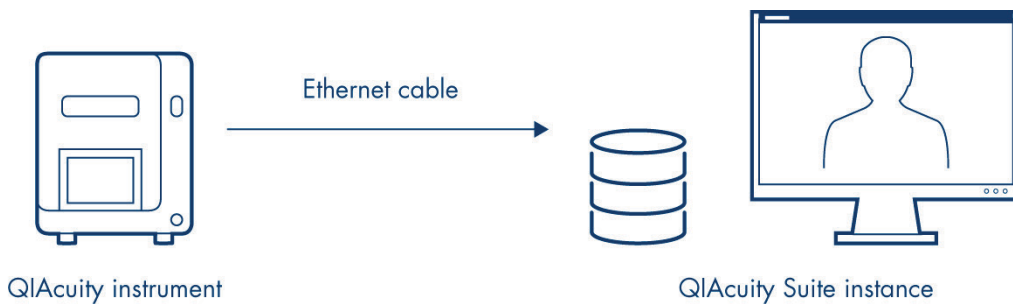

The QIAcuity instrument and QIAcuity Software Suite are connected via Ethernet cable.

Alternatively, both the QIAcuity instrument and the computer running the QIAcuity Software Suite can be connected to a LAN (local area network). This configuration allows the QIAcuity notebook or a separate computer to work as a server to which multiple clients can be connected. The QIAcuity Suite server instance and QIAcuity clients need to be connected through a network.

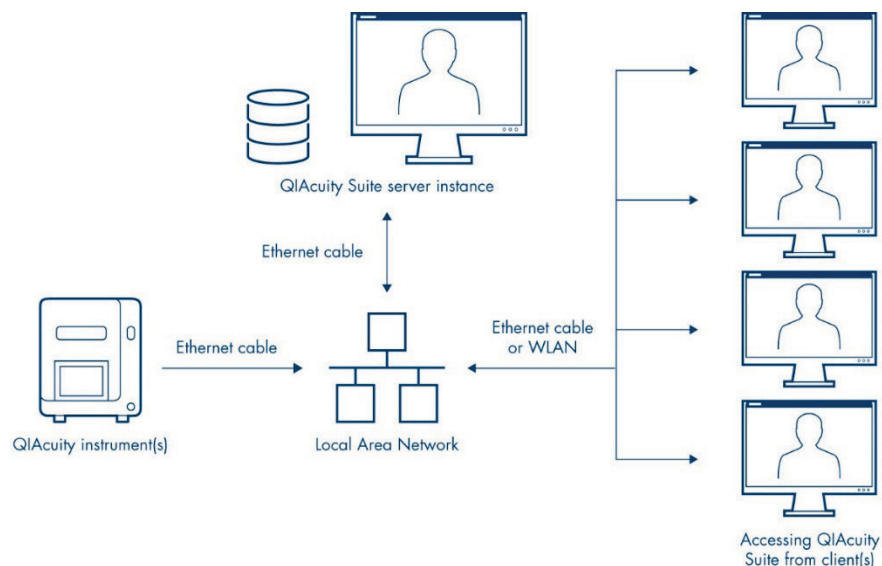

The QIAcuity instrument(s) and QIAcuity Software Suite are installed to a network, allowing multiple clients to access the QIAcuity instrument(s) via a single QIAcuity Suite server. For connection to the Suite server, use the IP address of the Suite server.

4.9.1 Configuring an Ethernet connection between the QIAcuity instrument and the QIAcuity Software Suite

To establish a connection, the instrument and the notebook must be connected to the LAN (local area network). For 10 users accessing the system in parallel, the requirement is a minimum data connection speed of 10Mbit/s for a setup via network.

Note: Please make sure that the QIAcuity instrument is connected to the LAN. Any other configurations are not supported by QIAGEN.

Note: Only users with Administrator role can modify the network configuration. We recommend to consult your network administrator when configuring the network. For communication with QIAcuity Software Suite, the following ports are used:

- The inbound TCP port 44321
- The inbound TCP port 8080
- The inbound TCP port 8687
- The inbound UDP port 9595

Pinging the network is also supported.

Note: If you changed the connection with the instrument from direct to LAN or from LAN to direct, or the IP was reassigned, refer to point (d) under the Installation and maintenance section of Troubleshooting the instrument and software.

Follow the steps below to configure the notebook running the QIAcuity Software Suite.

1. Go to the **Control Panel** app.

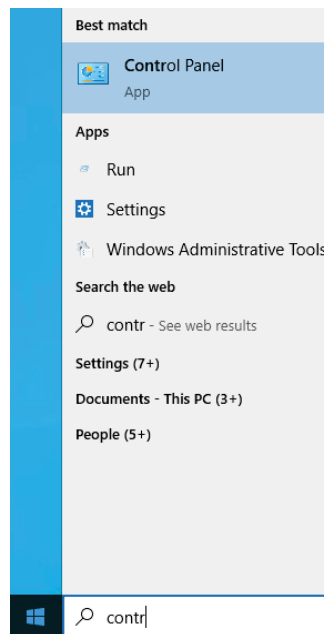

2. Click **Network and Internet** (if not available, proceed to the next step).

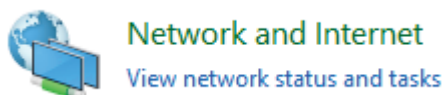

3. Click Network and Sharing Center.

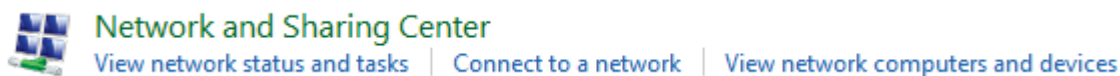

4. On the left pane, click **Change adapter settings**.

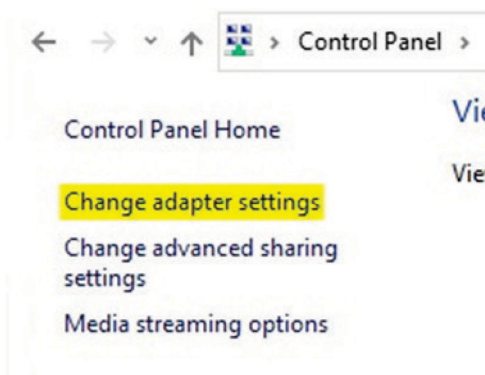

5. Right-click the ethernet network adapter and select **Properties**.

6. Select **Internet Protocol Version 4 (TCP/IPv4)** and click Properties.

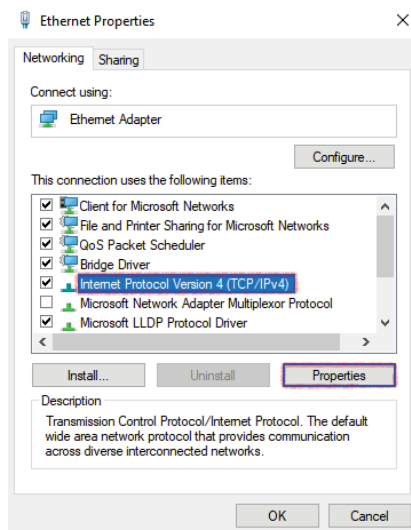

7. Select **Obtain an IP address automatically**. If your organization does not provide DNS details, select **Obtain DNS server address automatically** as well. Click **OK**, then **Close**.

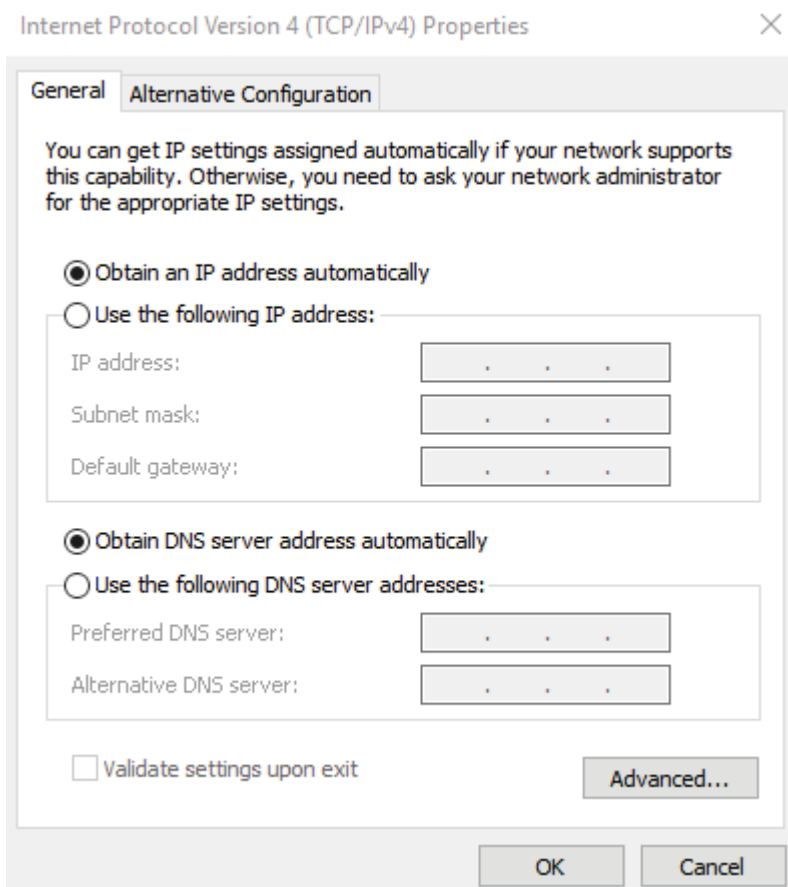

Optional: You can check if the addresses have been assigned properly by following the steps below.

8. From your Home screen, click the Search icon. Enter **cmd** and press the **Enter** key.
9. Wait for the command line window to open. Enter **ipconfig** command.
10. The address should be visible under the ethernet interface name for which modifications were made.

Follow the steps below to configure the QIAcuity instrument.

1. Log into the Instrument using the following credentials:
 - 1a. Login: SetupUser
 - 1b. Password: 2#ConnectSuite
2. On the toolbar, tap **Configuration**.

3. Select the Ethernet tab.

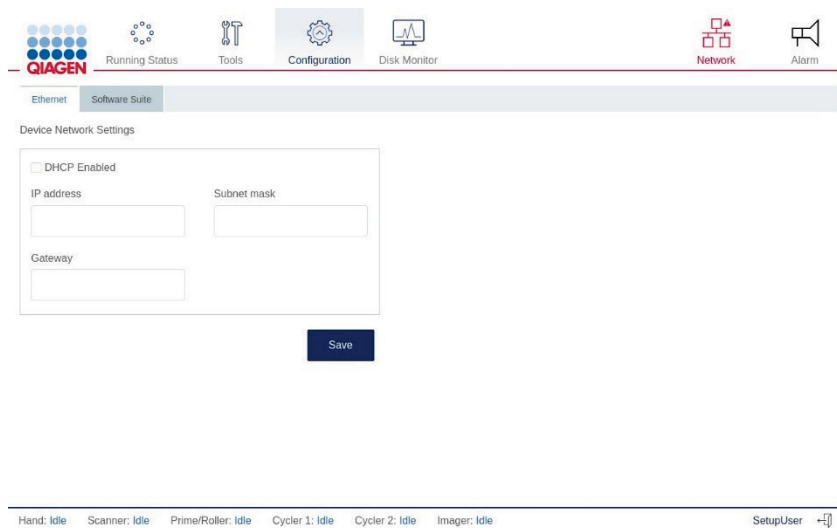

4. Check the **DHCP Enabled** box. If you check this box, the IP address and MAC address fields are disabled. The assigned IP and MAC addresses of device are displayed in the **IP address** and **MAC address** fields.

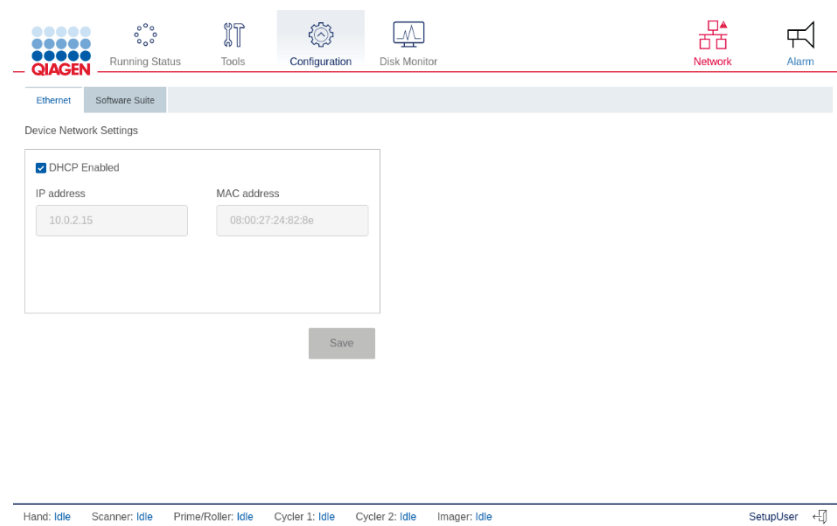

5. Tap **Save**.

4.9.2 Configuring a direct cable connection between the QIAcuity instrument and the QIAcuity Software Suite

Note: Before you start, ensure that the QIAcuity instrument and the notebook are connected with an Ethernet cable.

Note: Please do not use any USB network adapter in addition to the ethernet cable connected to the instrument.

Follow the steps below to configure the notebook running the QIAcuity Software Suite.

1. Go to the **Control Panel** app.

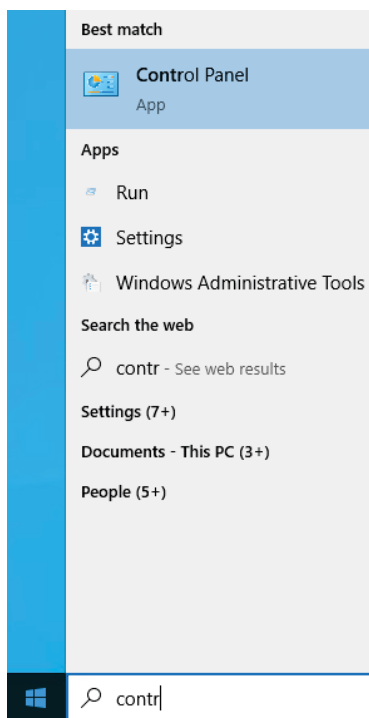

2. Click **Network and Internet** (if not available, proceed to the next step).

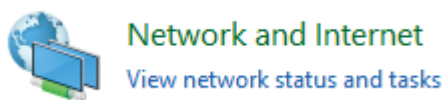

3. Click Network and Sharing Center.



4. On the left pane, click **Change adapter settings**.

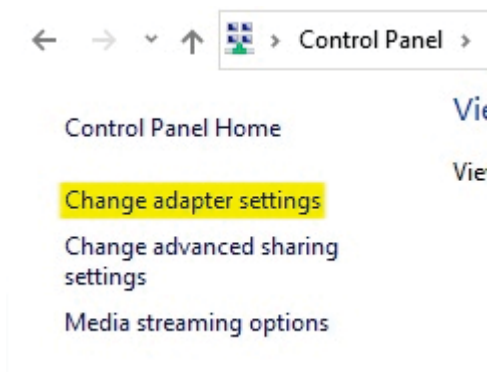

5. Right-click the ethernet network adapter and select the **Properties** option.

6. Select **Internet Protocol Version 4 (TCP/IPv4)** and click Properties:

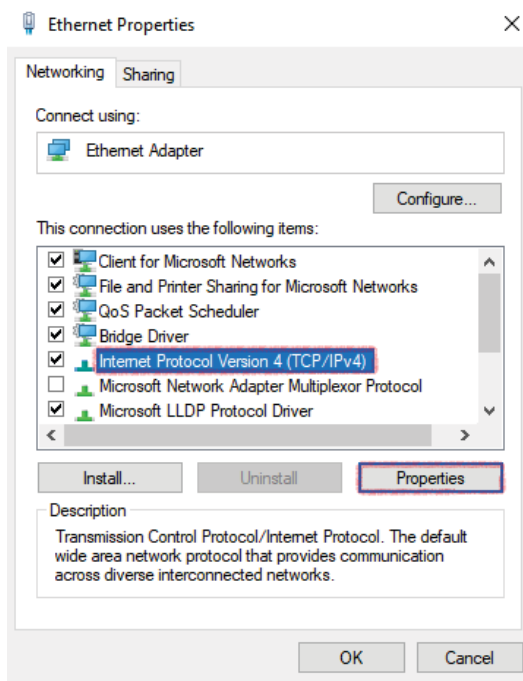

7. Select **Use the following IP address**. Enter the following information:

- **IP address:** Enter **192.168.1.1**.
- **Subnet mask:** Enter **255.255.255.0**.
- **Default gateway:** Enter **192.168.1.254**.
- **Preferred DNS server:** Enter the DNS server address.
- **Alternative DNS server:** Enter the alternative DNS server address.

Note: If the **Preferred DNS server** and **Alternative DNS server** fields are left blank, the connected is showed as unknown.

8. Click **OK**, then click **Close**.

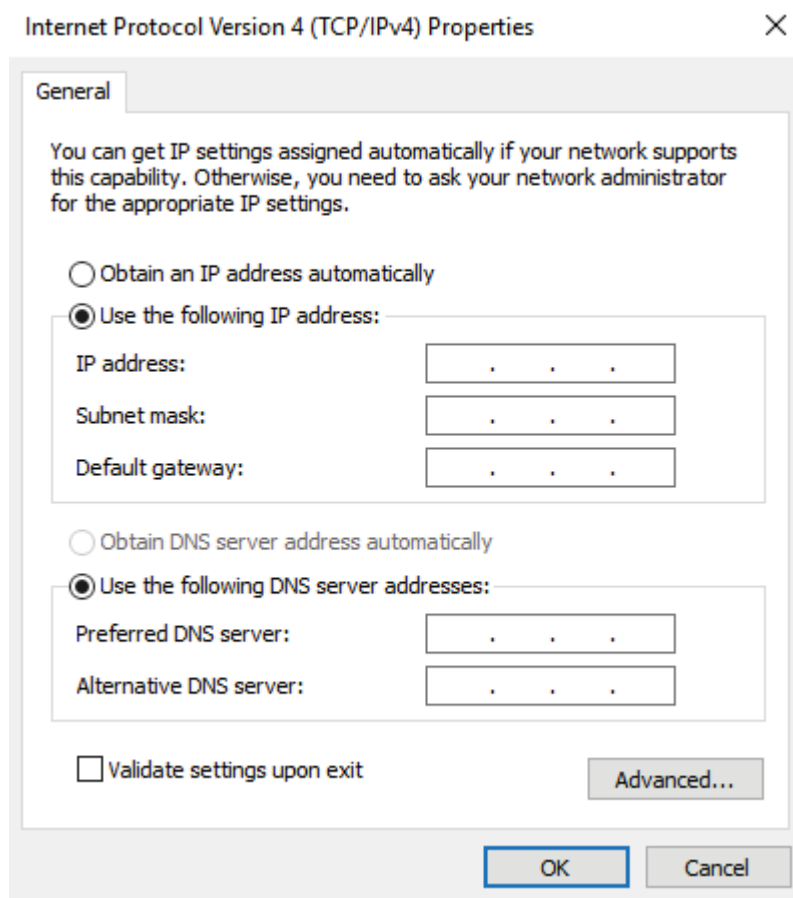

Optional: You can check if the addresses have been assigned properly by following the steps below.

9. From your Home screen, click the Search icon. Enter **cmd** and press the **Enter** key.
10. Wait for the command line window to open. Enter **ipconfig**.
11. The address should be visible under the ethernet interface name for which modifications were made.

Follow the steps below to configure the QIAcuity instrument.

1. On the toolbar, tap **Configuration**.
2. Select the Ethernet tab.

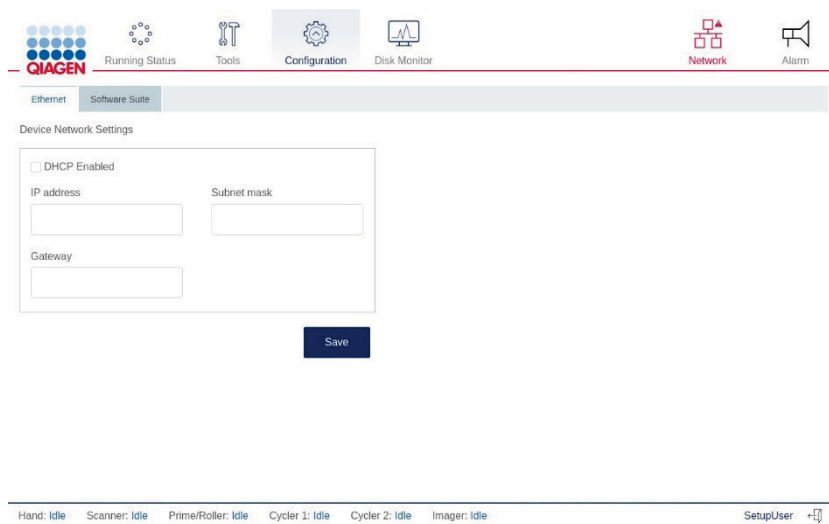

3. Ensure that the **DHCP Enabled** box is not checked. Enter the following information:

- **IP address:** Enter **192.168.1.2**.
- **Subnet mask:** Enter **255.255.255.0**.
- **Gateway:** Enter **192.168.1.1**.

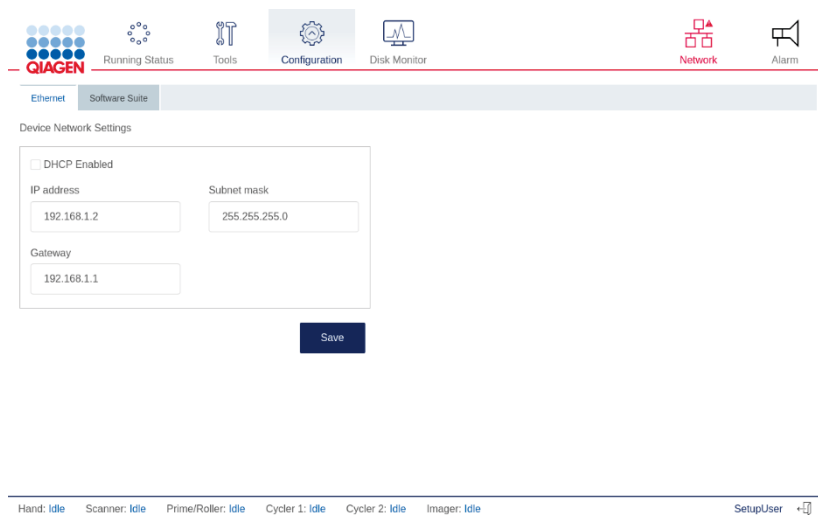

4. Tap **Save**.

4.9.3 Configuring the connection to the QIAcuity Software Suite in the QIAcuity instrument software

The QIAcuity instrument needs to be connected to the QIAcuity Software Suite to enable the exchange of data. To establish a connection, the instrument and the device in which the QIAcuity Software Suite is running must be connected to the same network.

Note: A plate run can only be performed if the QIAcuity Software Suite is connected to the instrument through a network or direct cable connection to the QIAcuity Software Suite server.

To connect the instrument to the QIAcuity Software Suite:

1. The Network Icon represents the connection between the QIAcuity Software Suite and the Instrument. When the icon is red, the connection is not established.
2. Log into the Instrument using the following credentials:
 - 2a. Login: SetupUser
 - 2b. Password: 2#ConnectSuite

Note: SetupUser is only allowed to log into the instrument when connection with the Software Suite is not established. Once established, login with SetupUser cannot be done.
3. On the Home screen, tap **Configuration**.
4. Tap the Software Suite tab.

The screenshot displays the QIAcuity instrument software interface. At the top, there is a navigation bar with icons for Running Status, Tools, Configuration (selected), Disk Monitor, Network, and Alarm. Below the navigation bar, there are two tabs: Ethernet and Software Suite (selected). The main content area is titled "Software Suite URL" and includes a checkbox labeled "Do not use a proxy." which is checked. Below this, there are three input fields: "Address" with the value "localhost", "Port number" with the value "8687", and "Instrument version" with the value "instrument/v0/". A "Test Connection" button is located below the input fields. At the bottom right of the main content area, there is a "Save" button. At the very bottom of the screen, there is a status bar showing the status of various components: Hand: Idle, Scanner: Idle, Prime/Roller: Idle, Cyclor 1: Idle, Cyclor 2: Idle, Imager: Idle, and the user name "SetupUser" with a plus icon.

5. Enter the IP address in the address field of the **Software Suite URL** section.

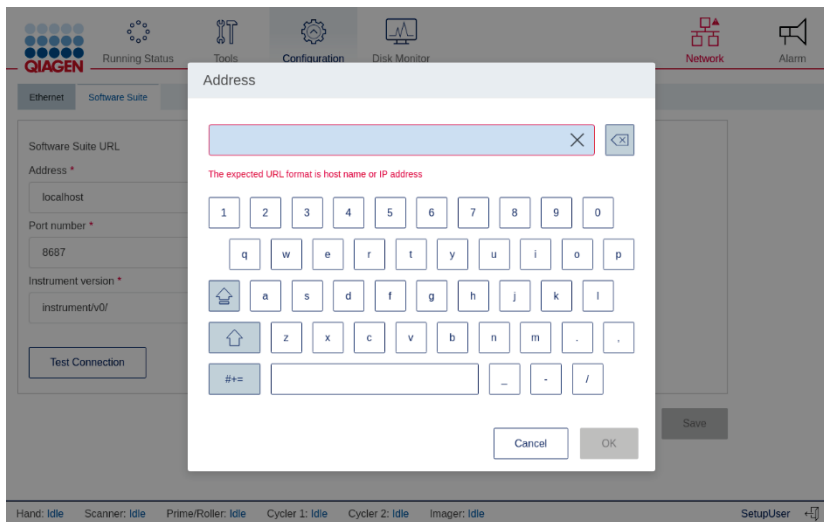

6. If required, enter the port number (default: 8687).

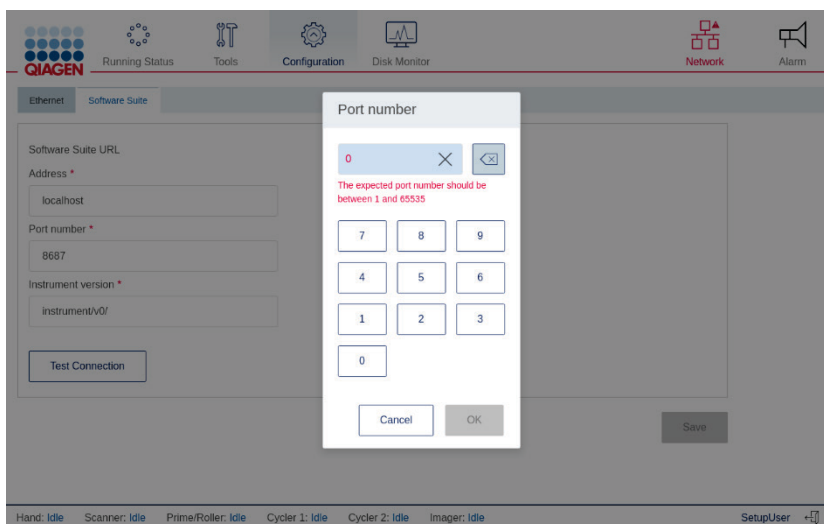

Note: To get the IP address of the Suite Server, the instrument must be connected to the Suite Server. From your Home screen, click the Windows icon and navigate to **Command Prompt**, or enter **cmd** in the Search field. A command line window appears. Enter **ipconfig** to view the network settings.

7. If you do not want to configure proxy settings, ensure that the **Do not use a proxy** box is checked. Then, tap **Test** to test the connection.

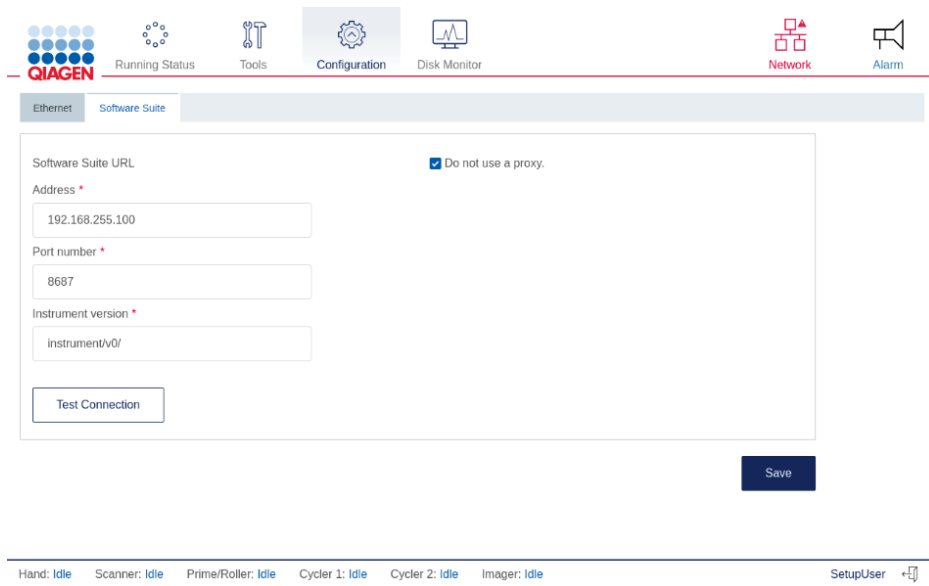

Note: An error message displays if the address and port number you entered are invalid. Tap **OK** to close the error message, and then re-enter the correct address and port number in the address field in the **Software Suite URL** area.

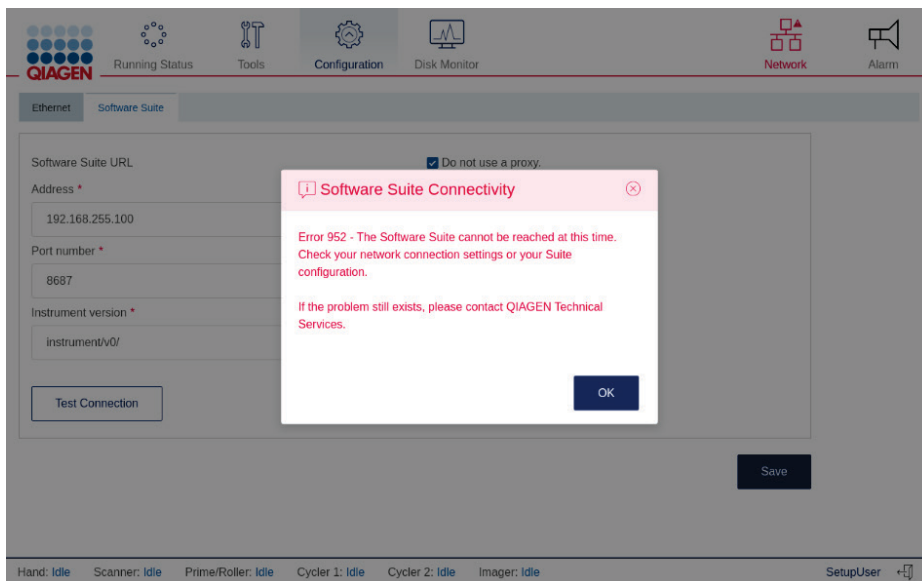

8. If you want to configure the proxy settings in your network configuration, clear the **Do not use a proxy** box and enter the following information:

- **Proxy Server:** Enter the proxy server address.
- **Proxy Port:** Enter the port address.
- **User Name:** Enter the username.
- **Password:** Enter the password.

The screenshot displays the QIAGEN software configuration interface. At the top, there is a navigation bar with icons for Running Status, Tools, Configuration (selected), Disk Monitor, Network, and Alarm. Below this, there are tabs for Ethernet and Software Suite. The main content area is a form for configuring proxy settings. It includes a checkbox labeled "Do not use a proxy." which is currently unchecked. To the left of this checkbox are three input fields: "Address" with the value "192.168.255.100", "Port number" with the value "8687", and "Instrument version" with the value "instrument/v0/". Below these is a "Test Connection" button. To the right of the checkbox are three input fields: "Proxy Server", "Proxy Port" with the value "0", "Username", and "Password". A "Save" button is located at the bottom right of the form. At the very bottom of the screen, there is a status bar showing the status of various components: Hand: Idle, Scanner: Idle, PrimeRoller: Idle, Cyclor 1: Idle, Cyclor 2: Idle, Imager: Idle, and SetupUser.

9. Tap **Save**.

4.10 Getting started with the QIAcuity

4.10.1 Configuration of the QIAcuity

If you are using QIAcuity for the first time, we recommend that you define the required settings. Other settings can be changed later, when needed.

For more information about using the touchscreen and software, refer to Operating the QIAcuity Instrument.

4.10.2 Procedure

1. Press the **Power** button to turn on the instrument.
2. The startup screen appears on the touchscreen. Wait until the initialization tests are finished.

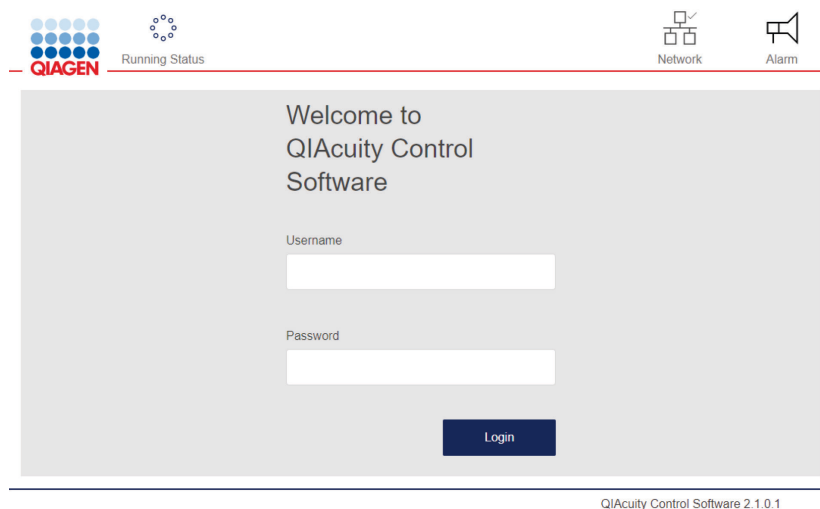

3. Enter the following information in the Login page. Tap the field to begin typing.
4. User ID: admin
5. Password: admin (Unless the password was already updated in Software Suite previously, then use the current one).

Note: Admin user account is available once connection to the Software Suite is established following the steps described in section "Configuring the connection to the QIAcuity Software Suite in the QIAcuity instrument software".

6. Tap **Login** to continue.

7. The Home screen appears.

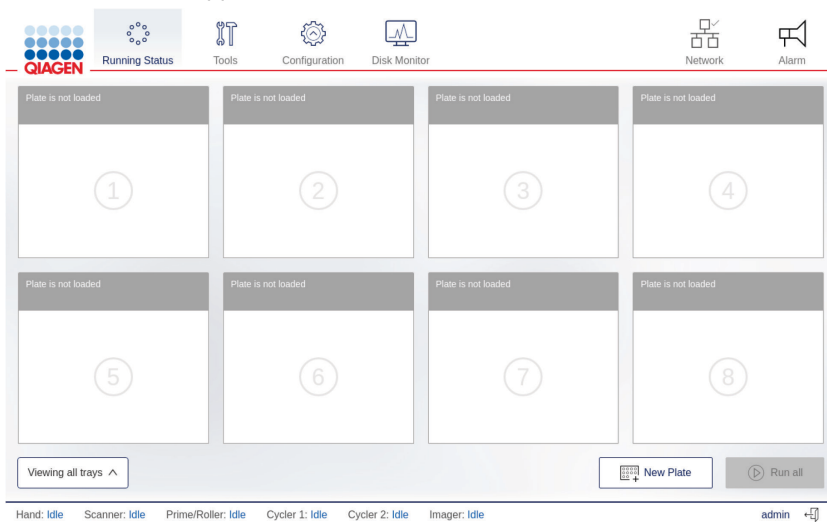

Note: To return to the Home screen from another screen, tap **Running Status**.

4.10.3 Setting basic system data

This section describes how to set your preferred name for the instrument.

To set your preferred QIAcuity name:

1. On the Home screen, tap **Configuration**.
2. Select the System tab.
3. Specify your preferred instrument name in the **Device Name** field. If this field is left blank, a default name is automatically generated for each QIAcuity instrument.

Note: Names can have up to 24 characters: letters A–Z, a–z, 0–9, and a hyphen (-). Do not start the instrument name with a digit or a hyphen. Instrument names also cannot end with a hyphen.

4. The default device name uses the following naming convention: QIAcuity-<serial number of the instrument>.

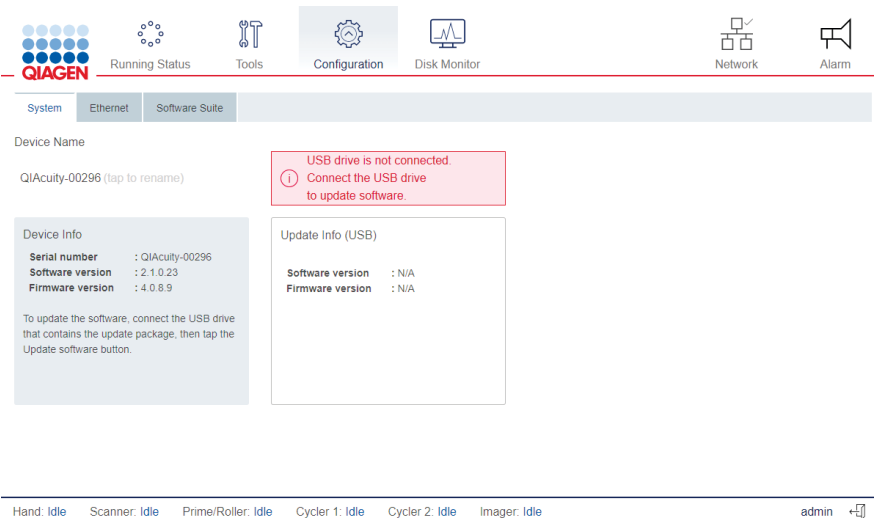

4.10.4 Managing users

The QIAcuity requires users to log in before accessing instrument functionalities. Each user must have a user account with an appropriate role assigned to it. The QIAcuity supports various pre-designed user roles and customer created user roles. Each role has different access rights to QIAcuity functions described in section User management.

Note: After 3 unsuccessful login attempts, a user is temporarily blocked and needs to wait 10 minutes to unblock the account.

Note: In version 2.1, after 30 days, passwords expire and every user (except the user with login "admin" provided automatically by QIAcuity Suite installation) is being asked for password change. After update to 2.1 during first attempt to login into an instrument, the user is informed about the need to update the password in Software Suite. Once at least an additional user with administrator rights has been created it is recommended to deactivate the initial admin (for which password does not expire).



Welcome to QIAcuity Control Software

Username

Password

Password has expired. Set a new password in
Software Suite.

Login

QIAcuity Control Software 2.1.0.23

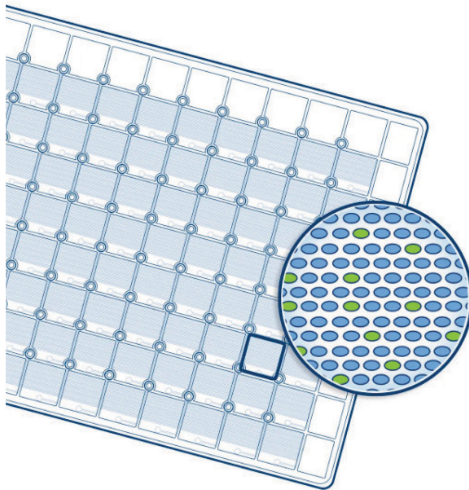

Welcome to QIAcuity Software Suite

Login

New password *

The password should contain min. 8 characters, at least one lower case letter, one upper case letter, one number and one symbol (e.g. -!\$% ^ & * () _ + | ~ = ' [] " ; < > ? . / #).

Repeat new password *

Change password

Your password expired. Please provide new password.

4.10.5 Synchronizing labware with the QIAcuity Software Suite

The QIAcuity Control Software and the QIAcuity Software Suite use labware files that include information about the nanoplate formats available. A labware file defines dimensional specification and default processing parameters for each Nanoplate. Information about the labware used by the QIAcuity can be downloaded from the Software Suite. The labware data is synchronized automatically when the instrument is turned on and the connection to the Suite is established. You can also synchronize it manually by clicking **Tools** and selecting **Labware Sync**. The labware is then downloaded and updated.

Note: Only user with appropriate rights are allowed to synchronize labware.

Note: Please make sure that after the first successful suite connection, the instrument is restarted to allow automatic synchronization of labware files. In case error 205 or 32 is shown, manually synchronize labware within the tools menu and restart the instrument.

Note: The connection between the QIAcuity and the Software Suite must be configured before starting this procedure. For more information on how to set up the connection, refer to section Establishing a connection between the QIAcuity instrument and the QIAcuity Software Suite.

To download labware information from the Software Suite, follow the steps below.

1. On the toolbar, tap **Tools**.
2. Tap Servicing.

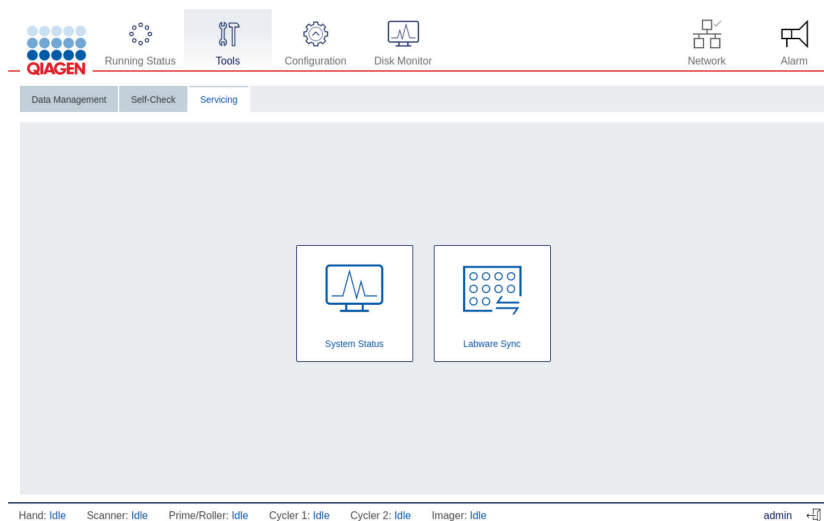

3. Tap **Labware sync**. The Labware synchronization dialog box appears.

4. The progress of the download is shown in the dialog box. Once the synchronization is complete, tap **OK** to finish the process.

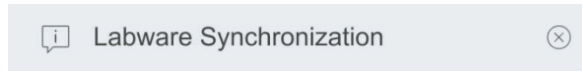















Labware is downloaded and updated successfully.



5 Operating the QIAcuity Instrument

The QIAcuity is operated through a touchscreen. Elements of the QIAcuity user interface are shown in the following table.

Table 4. QIAcuity interface elements

Button/Icon	Function
	Starts the run
	Stops the run
	Starts runs on all loaded plates
	Stops all runs
	Closes an open tray
	Ejects selected tray
 More	Displays an additional menu
	Enables the user to edit plate parameters
	Enables the user to create a new plate and specify its parameters
Text field	Enables to enter or edit a value using the on-screen keyboard
	Logs the user out
 Network	Indicates whether the instrument is connected to a network
 Running Status	Landing page with status of runs
 Configuration	Configuration
 Tools	Tools









5.1.1 Entering text and numbers

To enter text or numbers, tap the corresponding field. An on-screen keyboard is displayed on the touchscreen.

In some cases, the value required in a text field must meet a specific criterion. If required, the criteria are specified in the corresponding input window.

Note: For all text fields, a handheld scanner plugged into one of the USB-ports can be used to scan 1D barcodes. Buttons and icons related to the on-screen keyboards are shown in the following table.

Table 5. On-screen keypad buttons and icons

Button/Icon	Function
	Removes one character to the left of the cursor
	Clears the field
	Enables the user to type one uppercase letter. After the letter is typed, the keyboard will show lowercase letters again.
	Switches to uppercase letters. Allows the user to type multiple uppercase letters. To return to lowercase letters, press the symbol again.
	Shows special characters
	Shows alphanumeric characters
	Confirms the input and closes the window
	Discards the input and closes the window

If the entered value is not correct, the border of the textbox changes to red, and additional information about the field's requirements is shown. The input cannot be confirmed until the value entered in the box meets the requirements.

5.1.2 Turning on the instrument and logging in

To turn on the instrument and log into the software, follow these steps:

1. Press the **Power** button to turn on the QIAcuity.
2. The startup screen appears on the touchscreen and the instrument automatically performs initialization tests. After the initialization setup, the Login window appears.
3. Enter your credentials in the **Username** and **Password** fields.
4. **Note:** The **Username** field is case-sensitive.

5. **Note:** When connection to the Software Suite hasn't been established yet, log into the Instrument using the following credentials:

5a. Login: SetupUser

5b. Password: 2#ConnectSuite

For further information, please refer to section Configuring the connection to the QIAcuity Software Suite in the QIAcuity instrument software.

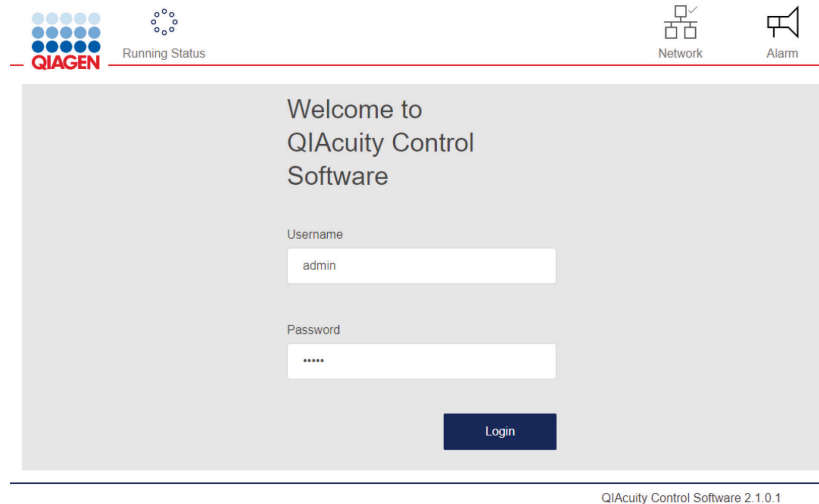

6. Tap **Login**.

7. The Home screen displays.

8. **Note:** If the username does not match the password or if the username does not exist, an error message is displayed on the screen. Re-enter the correct credentials in the **Username** and **Password** fields.

5.1.3 Setting up a run

Before starting a run, at least one plate must be created, and its name, plate type and dPCR parameters must be defined. We recommend that you define plates and their specific parameters (e.g., the run profile) using the QIAcuity Software Suite. For more information about setting up a plate using the QIAcuity Software Suite, refer to Operating the QIAcuity Software Suite. For creating a plate using the plate configurator of the instrument software, refer to Plate configuration procedure.

5.1.4 Setting up an experiment

Note: A plate run can only be performed if the instrument is connected to the QIAcuity Software Suite either through a network or a direct cable connection to the QIAcuity Software Suite server.

Note: It is recommended to cover the plate within 30 minutes after pipetting with the top seal to prevent subsequent filling issues.

Loading the trays and starting a run

The Home/Running status screen shows the current status of the trays and the slots inside them. If there are no plates loaded in the instrument, the screen displays empty panes and each pane has the **Plate is not loaded** label. You can load eight plates with QIAcuity Eight, four plates with QIAcuity Four, and one plate with QIAcuity One instrument.

Note: Loading and unloading plates during a run is supported by QIAcuity Eight and QIAcuity Four. To learn more about continuous loading and unloading, refer to section Continuous loading and unloading of plates.

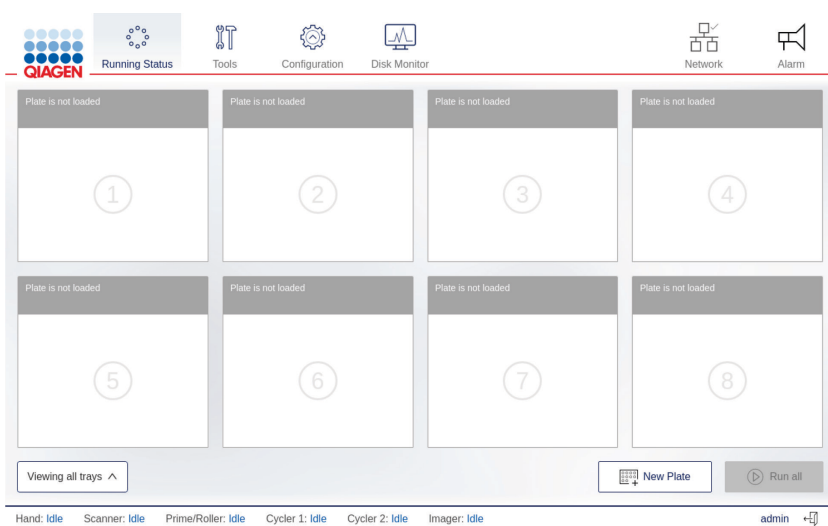

To load a tray and to start a run, follow these steps:

1. To eject a tray, press the physical button on the instrument or tap **Eject Tray** on the touchscreen.

Note: In QIAcuity Eight, you can select to eject the upper or lower tray from the list located below the panes.

2. Place a plate in one of the slots of the ejected tray. Ensure that the plate is placed in the correct orientation, facing the barcode toward the instrument and the QIAGEN lettering toward you. Also, ensure that the plate seal of the plate is intact and not overlapping to the sides for more than 1 mm. Repeat this step until all plates are loaded to the tray.

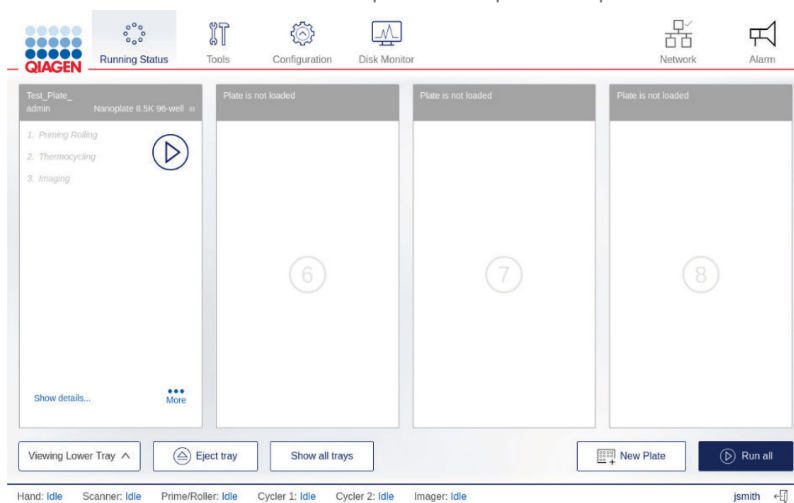

3. Tap **Close Tray** or press the physical button on the instrument to close the tray.
4. The instrument scans the barcodes on the plates. The instrument detects the availability of the plate and the label of the corresponding pane changes to **Plate is detected**. If the barcode matches to an existing experiment in the Software Suite, the loaded plate pane displays the defined run setup and can be started.

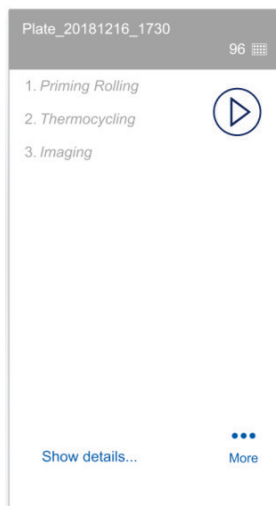

Note: In case the barcode does not match an existing plate in the Software Suite (e.g., if no barcode has been defined in the experiment setup), you can assign the plate manually from the list of pre-defined plates without barcodes.

Note: If the plate is expired, a warning message displays to indicate the expiration date. You may continue with this plate on your own risk.

5. To view the details of the plate, tap **Show details** in the corresponding plate's pane.
6. When all plates are correctly labelled and the corresponding data is received from the QIAcuity Software Suite, start the run.
 - To start the run on all plates simultaneously without making any changes, tap **Run all**.
 - To start the run of an individual plate without making any changes, tap the Run  icon on the plate's pane.
 - To edit the parameters of a plate before starting a run, follow the steps described in section Configuring a plate and starting a run.

Note: A run can only be started if the current user logged in has the appropriate rights.

Note: After a plate is loaded into the instrument, the QIAcuity sends a request to the Software Suite to lock the plate. This ensures that the plate is not modified by another user in the Software Suite while the plate is loaded and operated by an instrument. The plate is unlocked after it is unloaded from the instrument.

Configuring a plate and starting a run

You can configure a plate before (in Software Suite) or after it has been loaded to the instrument.

Note: For configured plates and loaded into instrument, only dPCR parameters can be changed; General Data cannot be edited. Changes are not allowed during the run.

To start the configuration of a plate that has been loaded into the instrument, follow these steps:

1. On the plate's pane, tap **More**.

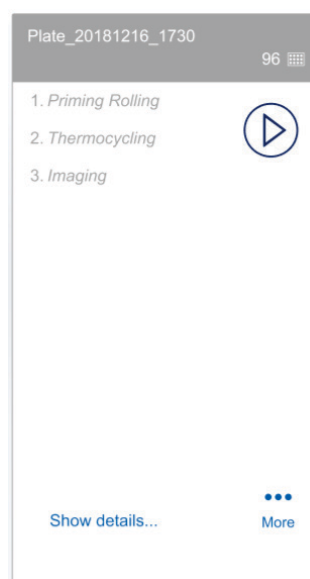

2. Tap **Edit plate** or **Create a new plate** to proceed to the plate configurator.

Note: The **Edit plate** button becomes available when a plate is loaded and the instrument successfully received the data from the Software Suite. The **Create a new plate** button is available when the plate's barcode is not found in the Software Suite database or when the QIAcuity cannot connect to the Software Suite.

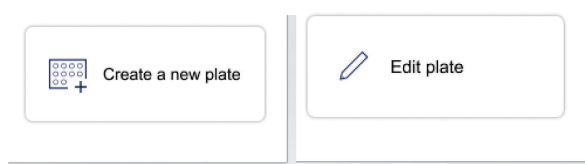

3. Proceed to Plate configuration procedure.

To start the configuration of a plate that has not been loaded into the instrument, follow these steps:

1. On the Home (Running status) screen, tap **New Plate**.

Note: The **New Plate** button is not available for single-plate instruments.

2. To input the barcode manually, tap the **Barcode** field. To scan the barcode using the external USB scanner, tap **Scan**.
3. Proceed to Plate configuration procedure.

Plate configuration procedure

To configure a plate and start the run, follow these steps:

1. In the General data step, enter the following information:
 - **Plate Name:** Enter the name of the plate.
 - **Note:** The plate type is automatically selected based on the scanned barcode.
 - **Description (optional):** Provide a description for the plate.

Note: If you are editing an existing plate, you can only change the value in the dPCR Parameter section. The fields in the General Data section are disabled.

The screenshot shows the 'NEW PLATE CONFIGURATOR' interface for 'Plate 123'. It has two tabs: 'General Data' (selected) and 'dPCR Parameter'. Under 'General Data', there is a 'Plate Name' field with 'Plate 123' and 'Characters left: 91'. Below it is a 'Plate Type' dropdown menu set to '96 Wells (12x8)'. There is a 'Description (optional)' field with 'Characters left: 200'. A 'Barcode' field shows 'AABB_96'. At the bottom, it says 'Recommended next step: dPCR parameters'. Navigation buttons include 'Back to Running Status overview', 'Save', and 'Done'.

Note: If you are creating a plate, you are automatically assigned as an owner of a plate. Owners are displayed under plate name on running status page. Modifying owners of the plate is only possible by editing the plate in Software Suite.

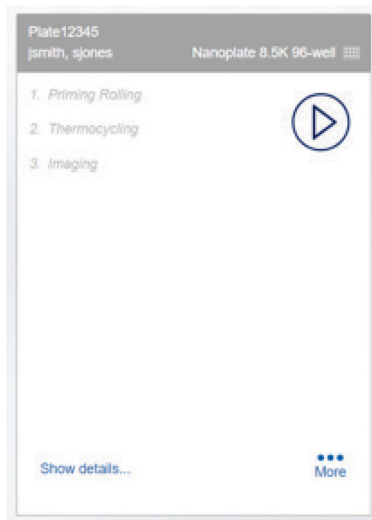

2. Tap **dPCR parameter** to proceed with the next step.

Note: Each step in dPCR parameter has its own tab. The Priming, Cycling, and Imaging tabs are mandatory.

3. In the Priming tab, select the applicable priming profile.

4. Perform the following steps in the Cycling tab:

4a. Enter your desired temperature in the **Temperature** field.

4b. In the **Duration** field, enter the cycling duration for the plate.

4c. Tap Add temperature step.

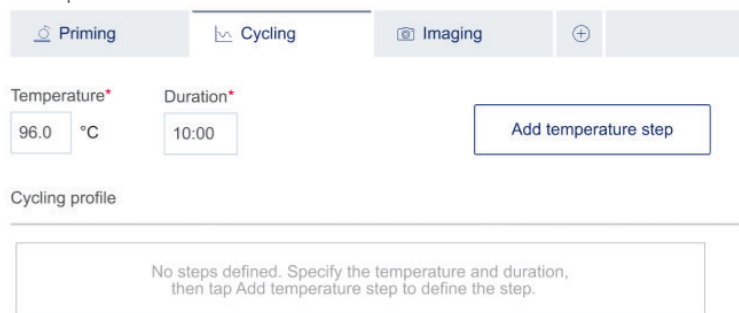

5. If you want to modify the temperature steps, refer to these steps:

- To edit or delete a temperature step, tap the **More**  icon, then tap **Edit** or **Delete**.



- To group the temperature steps, check the corresponding boxes of more than one temperature step, then tap **Group**.

- To ungroup a group of temperature steps, tap the **More**  icon, then tap **Ungroup**.

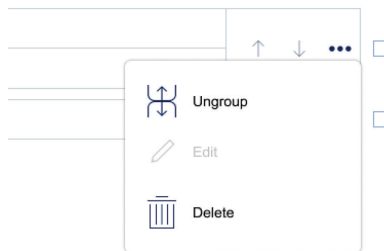

6. Perform the following steps in the Imaging tab:

6a. In the Imaging tab, select the applicable channel, then enter the exposure duration and gain in the **Exposure duration** and **Gain** fields.

6b. To include more steps in the run, tap the **Add**  icon, then select the applicable step. Provide the required information for the step. Repeat this step if more steps are needed for the run. In total, 9 steps can be performed per plate.

6c. Tap **Save** to save your progress or tap **Done** to save the run and go back to the Running Status window.

Note: If any required field is not completed, an error message displays to list the missing information required in each field.

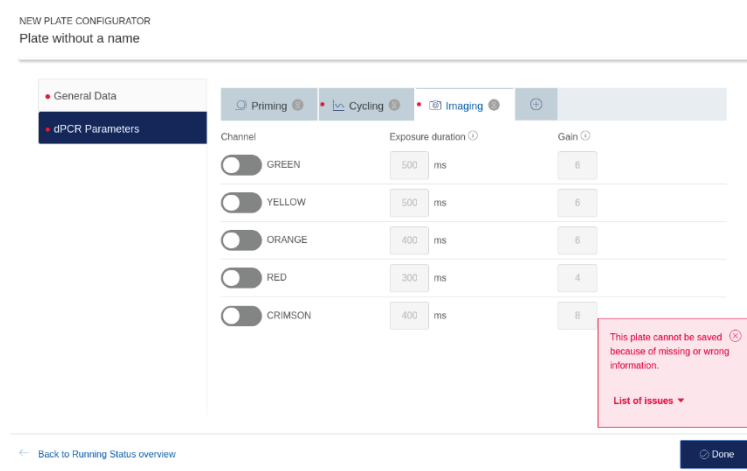

7. Start the run in the Running Status window:

- To start the run on all plates simultaneously without making any changes, tap **Run all**.
- To start the run of an individual plate without making any changes, tap the corresponding **Run** icon located on the  plate's pane.

Linking a plate to a pre-defined plate without existing barcode

If the instrument cannot match the barcode on a loaded plate to a barcode that already exists in the Software Suite, you can link the plate manually. Alternatively, you can create a new plate by following the steps in section [Configuring a plate and starting a run](#).

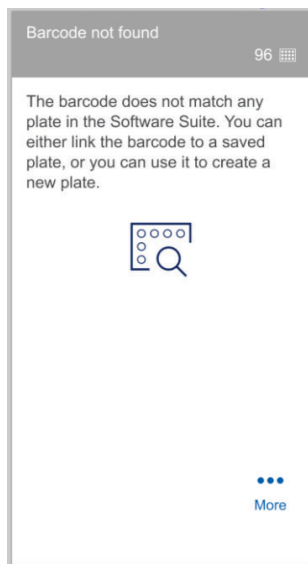

To link the barcode to a defined plate in the Software Suite, that has no barcode defined, follow these steps:

1. Tap the **Link**  icon.
2. In the Select Plate dialog box, select the plate that you want to link to the barcode of the loaded plate.

Note: Only plates with a **Defined** status without a barcode assigned can be linked.

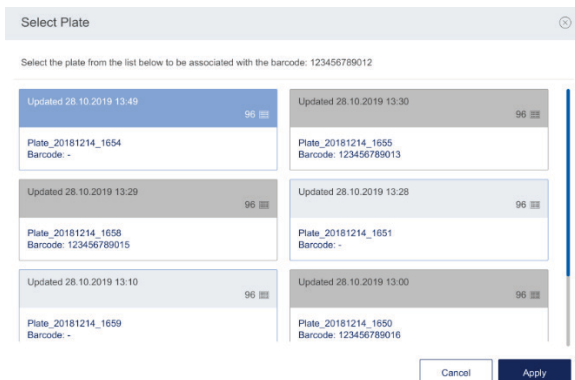

3. Tap **Apply**.

5.1.5 Tracking the run status

Once the run has started, you can track the status of the run. The plate that the QIAcuity is currently working with is distinguishable through the following elements:

- The **Running** status is displayed in the pane.
- The **Stop Run**  button is available.
- A status bar with the remaining time is displayed.

The panel also shows all the steps within the run. The font color of the steps that are completed is black. When a step is in progress, its font color is blue. Pending steps are shown in light gray.

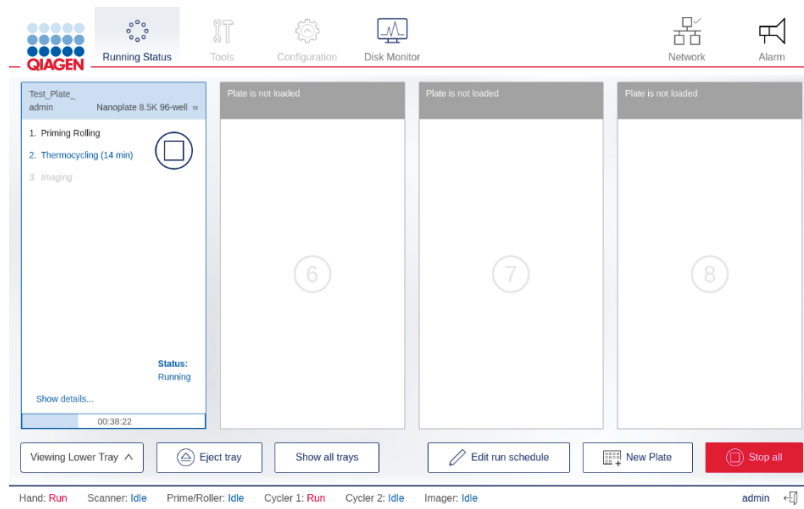

To view more details about the run, tap **Show details**. The dialog box appears containing information about the plate (in the General Data tab), as well as each step of the run (in the dPCR Parameter tab).

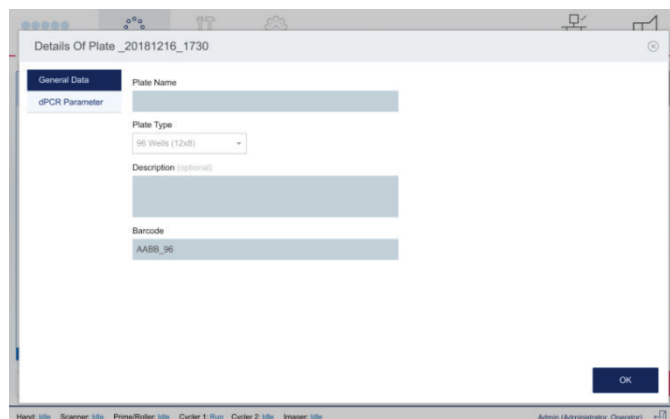

To view information about the individual steps of the run, tap **dPCR Parameter**, then tap the step which details you want to view. The instrument shows the status of each step of the run, and the remaining time of the current step. You can also view the parameters defined for each step.

Cycling profile 32 min 0 s

Start (room temperature)



1x	95 °C	2 min 0 s
40x	95 °C	15 s
	60 °C	30 s

End

Table 6 shows the meaning of each status icon that are shown in the dPCR parameter step.

Table 6. dPCR step status icon

Icon	Status
	The step is successfully finished.
	The step is being executed.
	The step is pending, and its execution will start after the current step is done.
	The step failed.

When the run is finished, the status of the run changes to **Done** and the **Eject**  button becomes available. To view the details about the run, tap **Show details**. To eject the plate, tap **Eject** button. 

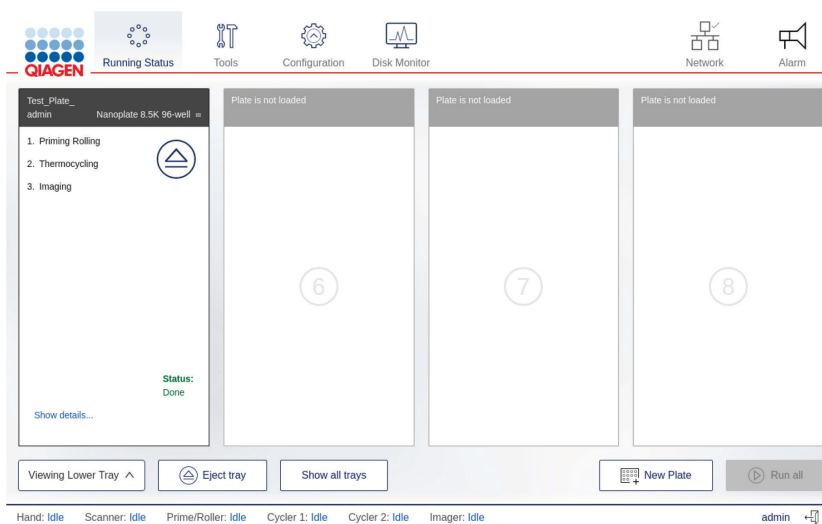

5.1.6 Continuous loading and unloading of plates



Note: The Continuous loading and unloading of plates function is only available with QIAcuity Eight and QIAcuity Four instruments. To unload a plate that is currently running in the QIAcuity One instrument, you need to abort the run. For more information, see section [Aborting a run](#).

You can also load and unload plates while the instrument is running. You can load new plates, unload finished ones, or remove plates that are still in progress. To eject a tray, press the physical button on the instrument, or tap **Eject tray** on the touchscreen. If any of the running plates are in the Imaging step, this process is paused. Once the changes in the tray are done, tap **Close tray** or press the physical button on the device to close the tray. The software checks the plates and displays the plate information on the screen. If any of the plates that were running before the tray was opened are missing, an error message appears, and the run is stopped.

Note: If the slot where the new plate is placed is also used by a plate that is in a different module, an error message is shown on the screen, and the new plate must be moved to a free slot. The drawer opens automatically, which can take up to two minutes. Move the plate and close the drawer to proceed.

Note: Depending on the time frame for unloading/loading of plates, the drawer opening might be delayed some time to finalize current movement steps.

5.1.7 Aborting a run

- If needed, a run can be stopped at any time. You can either abort all running plates or only the single running plates. To abort all runs on all plates, tap **Stop all**. Tap **OK** in the confirmation dialog box to proceed.
- To abort a single plate, tap the **Stop Run**  icon on its pane. All aborted plates return to their loading position on the tray.
- To unload the plates from the instrument, tap **Eject** .

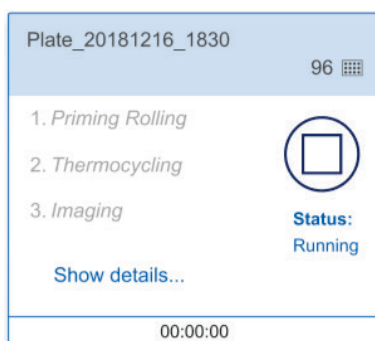

Aborting a plate during the priming/rolling step renders it unusable and the plate cannot be used and run again. A plate that has been aborted during the Thermocycling or Imaging step can be used again. To rerun the plate, configure a run with only the remaining steps. See section Rerunning a plate for more information.

Note: A run cannot be stopped during barcode scanning or when one or more trays are ejected.

Note: If the **Eject**  button is tapped or the physical eject button on the instrument is pressed before the plate is returned to the tray, a warning message is displayed on the screen, and the tray is not ejected.

5.1.8 Rerunning a plate

If a plate failed or was aborted during the Thermocycling or Imaging step, it can be run again after adding new cycling or imaging steps. You can add the steps either through the instrument's plate configurator or in the Software Suite. To add steps using the built-in plate configurator, follow the steps in Plate configuration procedure. If you want to use the Software Suite, refer to section Setting up an experiment.

Note: To modify a plate that was already used, you must remove it from the instrument. This ensures that the plate is unlocked and ready for modifications in the QIAcuity Software suite. If modifications should be done using the plate configurator, load the Plate again.

5.1.9 Editing the run schedule

Note: Editing the run schedule is only possible on QIAcuity Eight and QIAcuity Four and for those users having the appropriate permission (please see Table 9).

When a run starts, it is added to the run schedule and the **Edit schedule** button is shown on the screen. If the runs are started individually, they will be added to the schedule in the order which they were started by tapping the **Run**  icon on their respective panes. If all the runs are started at the same time, using the **Run All** button, there is a default order in which the plates are run.

In QIAcuity Eight, the run starts with the first slot in the upper tray and ends with the last slot in the lower tray. The slot numbers are presented in Table 7.

Table 7. Slot numbers the QIAcuity Eight

Tray	Slot numbers			
Upper	1	2	3	4
Lower	5	6	7	8

In QIAcuity Four, the run starts with slot number 1, and ends with slot number 4. The slot numbers are presented in Table 8.

Table 8. Slot numbers of the QIAcuity Four

Slot numbers			
1	2	3	4

To edit the run schedule, follow these steps:

Note: Only runs that are not started yet (with Pending Run status) can be rearranged.

1. On the Running Status screen, tap **Edit run schedule**.

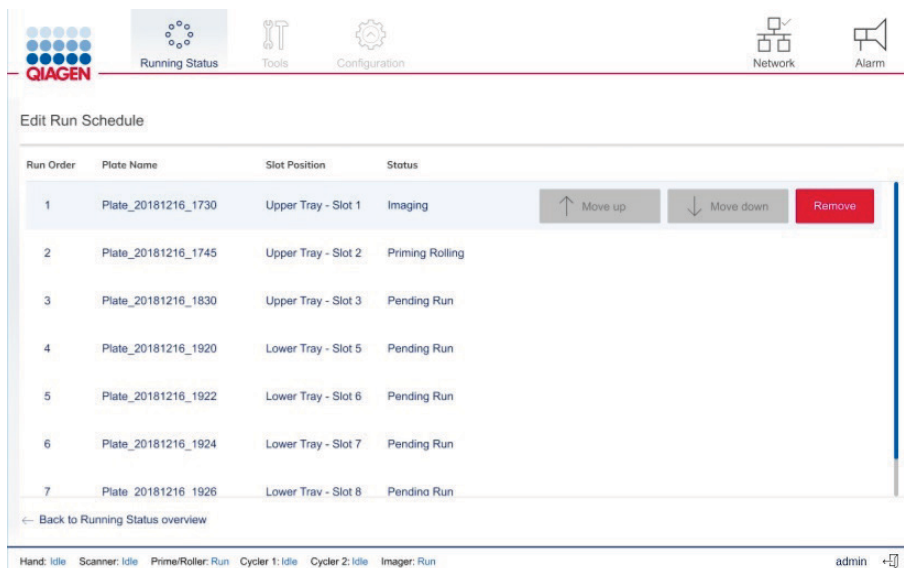

2. Tap the row corresponding to the plate that you want to move.

3. Perform one of the following actions:

- Tap **Move up** to move the plate run to an earlier position.
- Tap **Move down** to move the plate run to a later position.
- Tap **Remove** to cancel the plate run. Tap **Back to running status overview** to go back to the Running status window.

5.1.10 Viewing notifications

If the QIAcuity detects an error that affects the workflow of the instrument that the user can resolve, a notification displays on the screen.

To view a list of all notifications and possible solutions to the errors, tap the **Alarm**  icon. The last three errors are shown. If there are more than three errors, tap **View all** to view the full list of errors.

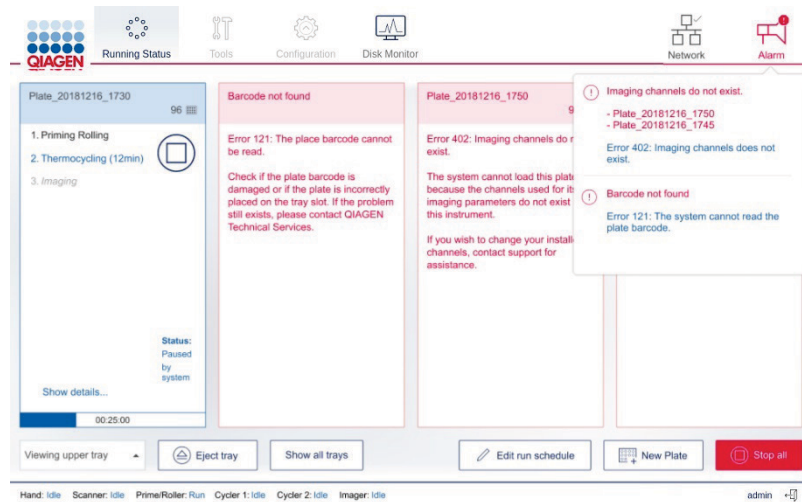

5.1.11 Disk monitoring

The Disk Monitor icon located in the header shows the real-time usage of the disk (free space and usage percentage). Depending on the space left, the information is shown in different colors. The Disk Monitor icon can be as follows:

1. Blue - when the disk occupation percentage is below 75% of the entire disk space

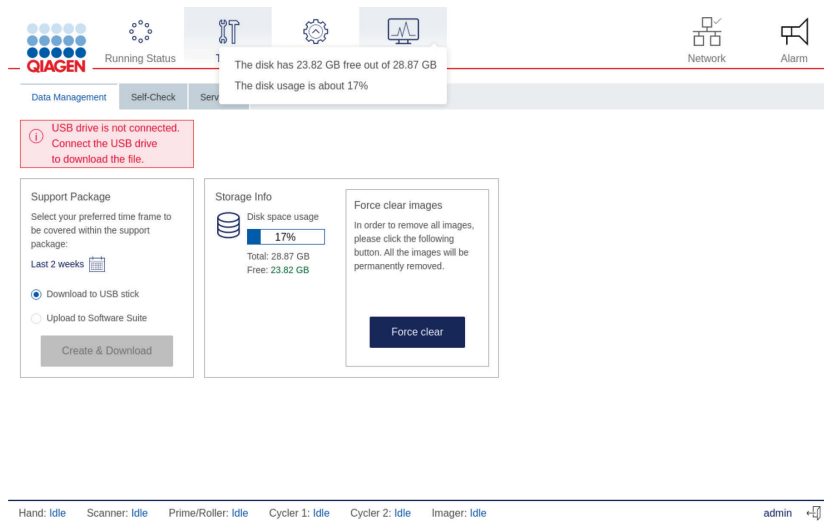

2. Yellow - when the usage of the disk occupation rises above 75%

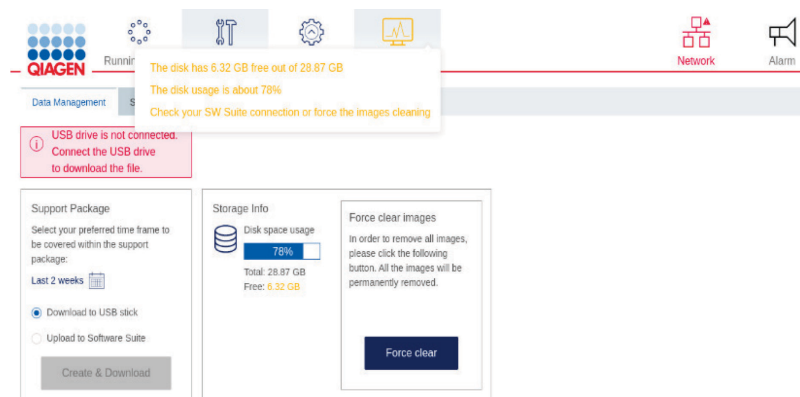

3. Red - when the remaining free disk space is less than 4 GB (~14%)

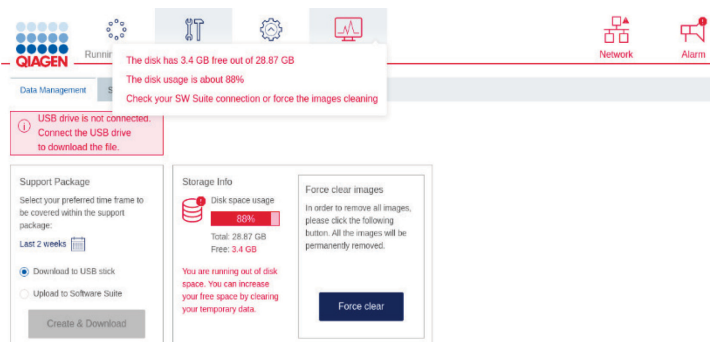

In case of 2 and 3, additional information is shown to inform about the actions that should be taken to gain the disk space: forcing the clearing of images, which haven't been transferred to Software Suite or setting up a connection with Software Suite.

5.1.12 Logging out

Note: If a run is processing, you can still access its status, even if you log out of the instrument. For more information, refer to Accessing the run status when you are logged out.

To log out of the instrument, follow these steps:

1. Tap the **Logout**  icon located at the bottom right of the touchscreen.

Note: The **Logout**  button is disabled when the instrument is being calibrated or when a tray is ejected. However, you can log out when a plate is running.

2. In the Confirmation dialog box, tap **OK** to confirm or tap **Cancel** to go back.

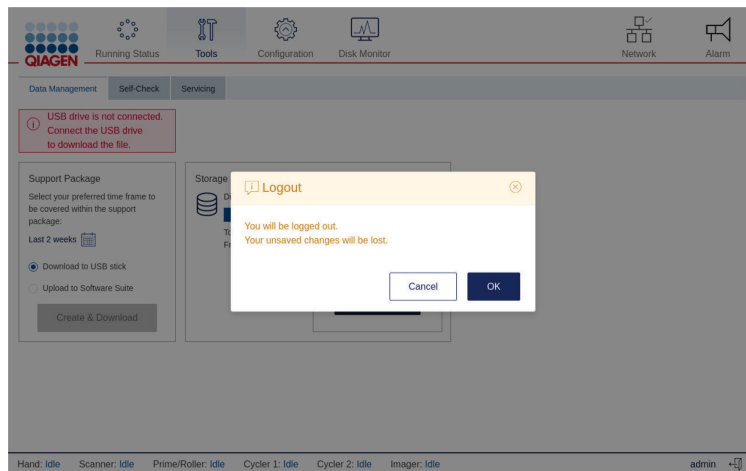

Automatic logout

Users are automatically logged off after a 15 minute period of inactivity.

Note: For unsaved data, for example, during plate creation, an automatically log out will lead to loss of entries.

Accessing the run status when you are logged out

After you log out, the Login screen is displayed on the QIAcuity display. To view the run status of an ongoing run, tap Running status. The Running status screen is displayed in view-only mode. All functions are disabled. To perform any actions related to the run and the plates that are being processed, log into the instrument.

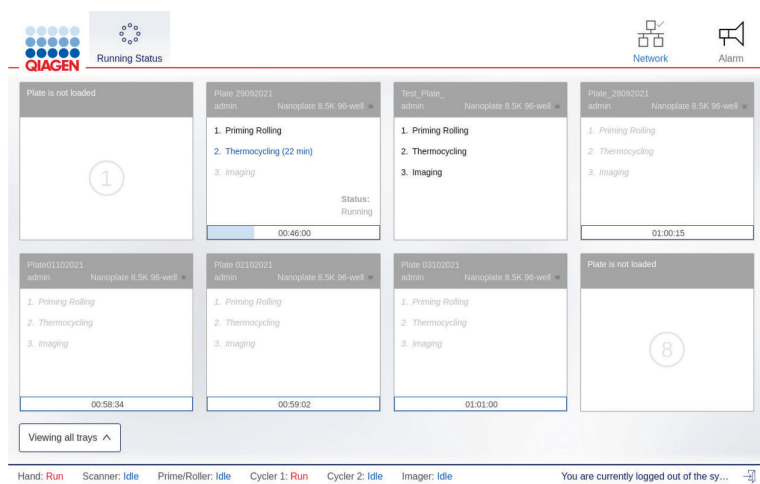

6 Operating the QIAcuity Software Suite

6.1 Getting started

This section describes the workspace within the QIAcuity Software Suite, its basic concepts, and the general software use.

Note: If the network connection was set up, the Suite can be accessed via another laptop using the IP address of the Suite server. Up to 10 users can access the system in parallel.

6.1.1 Software workspace

Main toolbar

The main toolbar shows navigation items. Clicking on the icon navigates to the overview of the selected area. Depending on your role, not all navigation areas might be visible. An active icon becomes highlighted.



Environment area contains the Plates, Templates, and Disk monitor and Archive icons. Users, Configuration, and Login settings are in the Configuration area.

Navigation areas

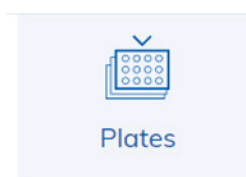

A Plate describes your experiment and contains all information regarding the experiment such as run setup, plate layout, and analysis results. See section Setting up an experiment and section Managing your plates to get more information.

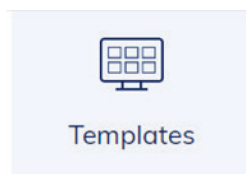

If you want to perform an experiment multiple times, you can create templates to enable a faster setup of plates. See section [Setting up an experiment](#) and section [Managing your templates](#) to get more information.

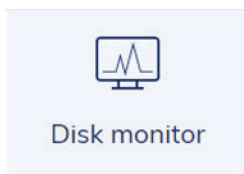

To operate the QIAcuity Software Suite, a free disk space is needed. See [Regular maintenance procedure of QIAcuity](#) for more information.



If you want to archive your plates on an external drive, you can configure the archive. See section [Archive](#) to get more information.

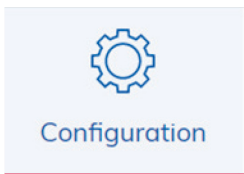

In the Configuration tab, you can access configuration features such as Instrument name, Archive Management, User Management, and Audit Trail. Only Administrator, Supervisor, Quality Assurance, and Lab leader roles have access to this panel. See [Operating the QIAcuity Software Suite](#).

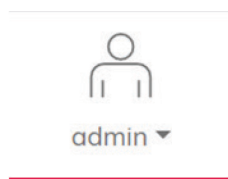

The Logged-in user is shown in the main toolbar. For more information, see [Concepts of the QIAcuity Software Suite](#).

Information bar

The information bar located at the bottom of the screen displays the software version.



6.2 Concepts of the QIAcuity Software Suite

6.2.1 User management

The QIAcuity Software Suite requires users to log in before accessing instrument functionalities.

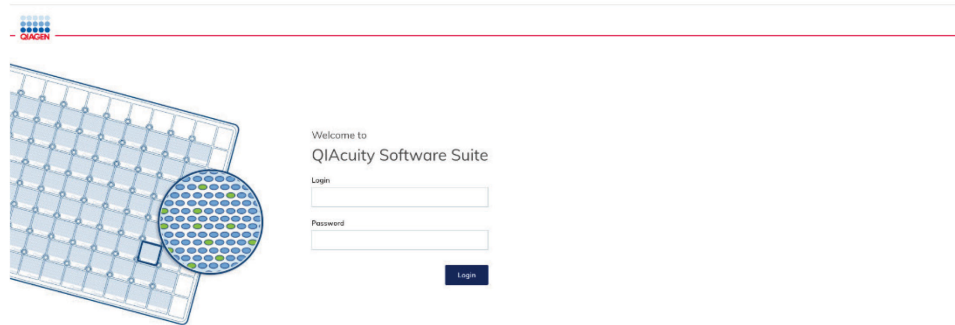

Each user must have a user account with an appropriate role assigned to it.

From QIAcuity Software Suite 2.0 and Control Software 2.0 onwards, the QIAcuity system offers an advanced user management, which supports users meeting Good Manufacturing Practice (GMP)/Good Laboratory (GLP) regulations. The user management is centralized and controlled by the QIAcuity Software Suite only. In contrast to older software versions, users can no longer be created and edited by the instrument control software. All users, their roles, and their permissions are created and edited in the Software Suite and are automatically transferred to the instrument control software, facilitating unique and synchronized user management information. In version 2.1, users can either select predefined roles or create their own by selecting proper permission.

As a consequence, all users created with older versions than SW 2.0 will be overwritten by the software suite user management during an update to CSW 2.0 or CSW 2.1. After completing the update to Software Suite 2.1 and CSW 2.1, users might have to be created again in the Software Suite 2.1.

Important: For update starting from Software Suite 2.0 and instrument control software 2.0, users will be migrated and forced to change their password during first login attempt (except the initial administrator user with login name "admin" provided by QIAGEN during the initial installation). When working with Good Manufacturing Practice (GMP)/Good Laboratory (GLP)

regulations, please deactivate this initial admin user (for which the password does not expire) once at least an additional user with administrator rights has been created.

The advanced User Management allows to create, edit, activate, and deactivate the user and provide a unique login and one password for both the instrument and the Software Suite (PC). Login is entered only once and cannot be changed. In addition, each user is assigned to a specific user role (see Roles).

A user role is a set of permissions to features relating to the instrument or the Software Suite (PC). Each user is assigned to one role only.

The centralized user management enables independent use of instrument software and Suite software. Regardless of which user is logged in with which role on the Suite software, another user can log in with a different role on the instrument. Both log-ins are completely independent from each other.

6.2.2 Roles

This section describes roles available in the QIAcuity Software Suite and Instrument Control Software. Roles may be viewed as the set of permissions and are designed in a way to suite both labs that need to fulfill Good Manufacturing Practice (GMP)/Good Laboratory (GLP) regulations and Molecular Biology Application (MBA) labs.

Admin, Supervisor, Group leader, Technician, and Quality Assurance are predefined roles designed for GMP/GLP labs, whereas Admin, Lab leader, and Operator are designed for MBA labs.

Note: All predefined roles cannot be edited or deleted.

1. Admin

The administrator is the role outside of the laboratory being responsible to configure the system and provide individual user access and rights. Users with this role will have extensive access to the QIAcuity instrument control software and QIAcuity Software Suite including the user management and audit trail access rights.

2. Supervisor

The supervisor has extensive access to QIAcuity instrument control software and QIAcuity Software Suite functionalities required to process plates and analyze results. Users with this role will not be able to delete plates and templates, and unlock or archive plates, and will not be allowed to access the user management. The audit trail functionality is limited to view the list of events and provide event details.

3. Group leader

The group leader has access to QIAcuity instrument control software and QIAcuity Software Suite functionalities required to process plates, analyze results, and manage archived plates but only for the plates that such user is assigned as owner. Users

with this role will not be able to delete plates and templates, and unlock plates, and will not be allowed to access the user management and audit trail.

4. Technician

The technician has limited access to the QIAcuity instrument control software and QIAcuity Software Suite inside the laboratory. Users with this role will only have access to process (create, run) owned plates and use existing templates to run an experiment.

5. Quality Assurance

The quality assurance is the role outside the laboratory. The role has rights to check all information about the plate, import plate, and create and sign reports. Users with this role will have audit trail read access, consisting of viewing and searching events, showing event details and also exporting audit trail for external review.

6. Lab leader

The lab leader is the role inside the laboratory and is designed for labs performing MBA. Users with this role will have extensive access to all QIAcuity instrument control software and QIAcuity Software Suite functionalities required to process plates and analyze results. This role also allows for basic user management functionalities to read user descriptions and their permissions.

7. Operator

The operator is the role inside the laboratory and is designed for labs performing MBA. Users with this role will have access to all general QIAcuity instrument control software and QIAcuity Software Suite functionalities required to process plates and analyze results. Deleting plates and access to the user management are restricted for these users.

In the table below, permissions assigned to the roles are presented.

Table 9. Default role permissions

	Administrator	Supervisor	Group leader	Technician	Quality Assurance	Lab leader	Operator
Log in							
Instrument	X	X	X	X	X	X	X
Suite Software	X	X	X	X	X	X	X
Instrument accesses							
Instrument Maintenance	X					X	
Experiment Schedule	X	X	X	X		X	X
Create Support Package	X	X	X	X		X	X
Plates							
Create Plate	X	X	X			X	X
All Plates							
Run Experiment	X	X				X	X
Edit Plate Data	X	X				X	X
Edit Analysis Data	X	X				X	X
Read Plate	X	X			X	X	X
Delete Plate	X					X	
Owned Plates							
Run Experiment	X	X	X	X		X	X
Edit Plate Data	X	X	X	X		X	X
Edit Analysis Data	X	X	X	X		X	X
Read Plate	X	X	X	X		X	X
Delete Plate	X					X	
Other permissions							
Import Plate	X	X	X		X	X	X
Export Plate	X	X	X			X	X

Table continued on next page

Table continued from previous page

Table 9. (cont.) Default role permissions

	Administrator	Supervisor	Group leader	Technician	Quality Assurance	Lab leader	Operator
Unlock Plate	X					X	
Set Plate Ownership	X	X	X			X	X
Upload VPF	X	X				X	
Upgrade Plate	X	X	X			X	X
Create Support Package	X	X	X	X		X	X
Create Report for Analysis	X	X	X		X	X	X
Sign Report	X	X	X		X	X	X
Delete Report	X					X	X
Templates							
Create Template	X	X	X			X	X
Edit Template	X	X	X			X	X
Read Template	X	X	X	X	X	X	X
Delete Template	X	X				X	
Archive							
Plate Archiving	X	X	X			X	X
Archive Overview	X	X	X		X	X	X
Restore Plate from Archive	X	X	X		X	X	X
Delete Plate from Archive	X					X	
User Management							
Read Users and Roles	X				X	X	
Create and Edit Users and Roles	X						
Activate and Deactivate User	X						
Delete Role	X						
System configuration							
Registered Instruments	X					X	
Manage Archive	X					X	
Audit Trail configuration							
View Audit Trail	X	X			X	X	
Audit Trail Toggle	X			X			

X – role has access to this permission

This section describes how the functionalities in the application are impacted by permission, which are assigned to user roles. Please pay special attention to notes, because some permissions require another one to work – Notes become visible when after checking checkbox.

6.2.3 Log in (Instrument and PC software)

1. Instrument — User can login to Instrument (login and password is needed).
 - Log into the Instrument by providing credentials.
2. Suite Software — User can login to Suite Software (PC software) (login and password is needed).
 - Log into the Suite by providing credentials
 - Change own password
 - Modify own user data
 - name
 - surname
 - If the user does not have access to log in but provides the correct login and password, then he/she is presented with the following message: "Insufficient permissions. Please contact administrator".

6.2.4 Instrument access (Instrument software)

1. Instrument Maintenance — User can update Instrument and go to Data Management, Self-Check, Servicing, and Configuration.
2. Experiment Schedule — User can set up dPCR parameters (priming, cycling, and imaging) and change the order of plates to be processed.
3. Create Support Package — User can download a support package to a USB drive and upload a support package.

6.2.5 Plates (Instrument and PC software)

Create Plate — User can set up dPCR parameters (priming, cycling, imaging), reaction mixes (reagents), samples (control, non-control), and create Plate layout.

- Create a new Plate (fill out General Data and scan barcode)
- Set up dPCR parameters
- Set up Plate layout (add/remove [before experiment run] reaction mixes, samples, and controls)

All plates

1. Run Experiment — User can run/stop an experiment and eject Plate(s) from instrument.
Note: 'Read all Plate' required to have fully available permission.
 - Start experiment in the Instrument

2. Edit Plate Data — User can check and edit parameters of existing Plate (dPCR parameters, Plate layout (samples, reaction mixes (reagents), controls), and mark it as primed.
Note: 'Read all Plate' required to have fully available permission.
3. Edit Analysis Data — User can change the threshold and use lasso selection on the Analysis page of all Plates to verify the accuracy of the results.
Note: 'Read all Plate' required to have fully available permission.
4. Read Plate — User can search for specific Plate, see all created Plates, analyze a Plate, check details about a Plate [dPCR parameters, plate layout (samples, reaction mixes, controls)], and export results to CSV.
5. Delete Plate — User can delete any Plates.
Note: 'Read all Plate' required to have fully available permission.

Owned plates

Work similarly as for all plates but apply only for plates that the user is the owner of.

1. Run Experiment — User can run/stop an experiment and eject owned Plate(s) from instrument.
Note: 'Read owned Plate' or 'Read all Plate' required to have fully available permission.
2. Edit Plate Data — User can check and edit parameters of owned Plate (dPCR parameters, plate layout (samples, reaction mixes (reagents), controls), and mark it as primed.
Note: 'Read owned Plate' required to have fully available permission.
3. Edit Analysis Data — User can change the threshold and use lasso selection on the Analysis page of the owned Plates to verify the accuracy of the results.
4. Read Plate — User can search the Plate, analyze the Plate, see all created Plates, check details about owned Plate (dPCR parameters, plate layout (samples, reaction mixes, controls)), and export results to CSV.
5. Delete Plate — User can delete owned Plates.
Note: 'Read owned Plate' required to have fully available permission.

Other permissions

1. Import Plate — User can import the Plate as a password protected ZIP file.
Note: 'Read owned Plate' or 'Read all Plate' required to have fully available permission.
 - Import plate
 - The **import plate** button is visible in Plates overview.
2. Export Plate — User can export the Plate as a password protected ZIP file.
Note: 'Read owned Plate' or 'Read all Plate' required to have fully available permission.

- Export plate

- The **export plate** button is visible after clicking the three dots (...) on the plate.
- The **export plate** button is visible in plate details view.

3. Unlock Plate — User can unlock locked Plate.

Note: 'Read owned Plate' or 'Read all Plate' required to have fully available permission.

- Unlock plate

- When a Plate is in locked status, then the **unlock plate** button is visible in plate details.
- **Note:** Only tap the **unlock plate** button in case the run was stopped by an instrument error and the instrument is not unlocking the plate, although it was taken out from the QIAcuity instrument. If the **Unlock plate** button is tapped during a run, the run will be stopped and the data will get lost.

4. Set Plate Ownership — User can set owners of the plate.

Note: 'Read owned Plate' or 'Read all Plate' and 'Edit owned Plate' or 'Edit all Plate' required to have fully available permission.

- Set plate ownership

- Plate ownership field in plate general data is active

5. Upload VPF — User can upload Volume Precision Factor.

- Upload VPF

- The **upload VPF** button is visible in Plates overview.
- The **upload VPF** button is visible in plate details.

- If the user does not have access rights to upload VPF, then information in the modal is changed as follows:
"The volumes of some nanoplates are not yet optimized. You can work with these results; however, to get the most accurate results, please contact your administrator".

6. Upgrade Plate — User can upgrade the Plate.

Note: 'Read owned Plate' or 'Read all Plate' required to have fully available permission.

- Upgrade plate

- The **upgrade** button is visible on the plate.
- The **upgrade** button is visible in plate details view.

7. Create Support Package — User can download a support package for the Plate.

Note: 'Read owned Plate' or 'Read all Plate' required to have fully available permission.

- Create support package

- The **support package** button is visible in plate details.

8. Create Report for Analysis — User can create and generate report using the charts and data from the Analysis of the Plate.

Note: 'Read owned Plate' or 'Read all Plate' required to have fully available permission.

- Add charts to reports
- Check selected items for report
- Create report (add report name, select or change report elements)
- Generate report

9. Sign Report — User can add signature to the report. Note: 'Read owned Plate' or 'Read all Plate' required to have fully available permission.

- Add signature and reason for signing to report

10. Delete Report — User can delete report.

Note: 'Read owned Plate' or 'Read all Plate' required to have fully available permission.

- **Delete report** button is visible in report list section (only not signed reports can be deleted)

6.2.6 Templates (Instrument and PC software)

If the user has any of the rights regarding templates, then the following requirements apply.

The user can go to **Template** (top-bar menu). If the user does not have "Read templates" permissions, then a modal is presented as follows:

"In order to view templates, you need to have 'Read templates' permission. Please contact administrator to get access rights".

1. Create Template — User can create new Template.

Note: 'Read Plate' required to be able to create template from plate.

- Create new Template
- Create Template from Plate

- If the user has "read plate" access rights

2. Edit Template — User can edit existing Template.

Note: 'Read Template' required in order to be able to edit template.

- Modify templates (and their parameters)

3. Read Template — User can read information about existing Templates and use them while creating and editing plates (if also has appropriate plate permissions). Access to all created Templates.

- Go to Template
- Read all Templates
- See all created Templates
- Search Templates (and sort them)
- Create Plate from Template
 - If the user also has “create plate” permission
- Import Template while creating new Plate
 - If the user also has “create plate” permission
- Import Template while editing Plate
 - If the user also has “edit plate” permission

4. Delete Template — User can delete existing Templates.

Note: ‘Read Template’ required to be able to delete template.

- Delete templates
 - The **delete** button is visible after clicking the three dots (...) on the Template.

Archive (PC software)

1. Plate Archiving — User can archive the Plate.

Note: ‘Read owned Plate’ or ‘Read all Plate’ required to have fully available permission.

- Go to Plates (top-bar menu)
 - If the user does not have “Read plates” permissions, then a modal is presented:
“In order to view plates, you need to have ‘Read plates’ permission. Please contact administrator to get access rights”.
- Archive the Plate (all/owned)
 - The **archive** button is visible after clicking the three dots (...) on the plate.
 - The **archive** button is visible in plate details.

2. Archive Overview — User has access to list of archived Plates. User can see all archived Plates, search for archived Plates, and check general information about archived Plate and disk space usage for the Archive in the Disk Space monitor.

- Go to Archive, Disk Space monitor
- See archive disk space (in Disk space monitor)
- See Archived plate
- Search Archived Plate (sort by Archived date, Plate name, Plate statuses, time frame, change view)
- See Archived plate general data

3. Restore Plate from Archive — User can restore archived Plates.

Note: 'Archive Overview' required to have fully available permission.

- Go to Archive, Disk Monitor
 - If the user does not have "Archive overview" permissions, then a modal is presented:
"In order to view archived plates, you need to have 'Archive overview' permission. Please contact administrator to get access rights".
- Restore the plate from archive
 - The **restore** button is visible after clicking the three dots (...) on the plate.
 - The **restore** is visible in plate details.

4. Delete Plate from Archive — User can delete any Plate from Archive.

Note: 'Archive Overview' required to have fully available permission.

- Go to Archive
 - If the user does not have "Archive overview" permissions, then a modal is presented:
"In order to view archived plates, you need to have 'Archive overview' permission. Please contact administrator to get access rights".
- Delete the plate from archive
 - The **delete** is visible button after clicking the three dots (...) on the plate.
 - The **delete** is visible in plate details.

User management (PC software)

1. Read Users and Roles — User can see the list of users and the list of roles in the system.

- Go to the configuration panel
- Go to the User Management tab
- Go to the Users tab in User Management

- See the list of users
- Search users
- Go to the Roles tab in User Management
- See the list of roles

2. Create and Edit Users and Roles — User can create and edit a user, and create and edit a role.

Note: 'Read user and roles' required to have fully available permission.

- Go to the configuration panel
- Go to the User Management tab
- Go to Users tab in User Management
- Go to Roles tab in User Management
 - If the user has no "Read users and roles" permissions, then a modal is presented instead of tables of users/roles: "In order to view users/roles list, you need to have 'Read users and roles' permission. Please contact administrator to get access rights".
- Create new users
 - **New user** button
- Edit existing users
 - **Edit user button** in row with user
- Create new roles
 - **New role** button
- Edit existing roles
 - **Edit role button** in row with role
- See permissions list
 - **Permission list button** in row with role
- See users list (assigned to role)
 - **Users list button** in row with role

Note: Roles designed for GMP/GLP (Administrator, Operator, Lab leader, Technician, Group Leader, Supervisor, Quality Assurance) cannot be edited.

3. Activate and Deactivate User — User can activate and deactivate a user. Note: 'Read users and roles' required in order to have fully available permission.

- Go to the configuration panel
- Go to User Management tab
- Go to the Users tab in User Management

- If the user has no "Read users and roles" permissions, then a modal is presented instead of table to users:
"In order to view users, you need to have 'Read users and roles' permission. Please contact administrator to get access rights."

○ Deactivate user

- **deactivate** button in row with user

○ activate deactivated user

- **activate** button in row with deactivated user

4. Delete Role — User can delete existing roles in the system. Note: 'Read users and roles' permission required in order to be able to delete roles.

- Go to the configuration panel
- Go to User Management tab
- Go to the Roles tab in User Management

- If the user has no "Read users and roles" permissions, then a modal is presented instead of table to users:
"In order to view roles you need to have 'Read users and roles' permission.
Please contact administrator to get access rights."

○ Delete role

- **Delete role** button in row with role

Note: Roles designed for GMP/GLP (Administrator, Operator, Lab leader, Technician, Group Leader, Supervisor, and Quality Assurance) cannot be deleted.

If some users are assigned to role also role deletion is not possible.

System configuration (PC software)

1. Registered Instrument — User can see list of registered instruments.

- Go to the configuration panel

- Go to the Instrument names tab
 - See the list of registered instruments
2. Manage Archive — User can edit Archive location, detach Archive, turn on/off, and configure automatic archiving.
- Go to configuration panel
 - Go to the Archive tab
 - Edit archive location
 - Detach archive
 - Set automatic archiving and its parameters
3. Audit Trail configuration
- 3a. View Audit Trail — User can see the list of Audit Trail events, search for specific event, check details of the event, and export it to PDF.
- Go to the configuration panel
 - Go to the Audit trail tab in the configuration panel
 - Go to the events list
 - See audit trail data
 - Filter audit trail data
 - Export audit trail data
4. Turn Audit Trail on and off — User can turn on/off the Audit Trail (events tracker).
- Go to the configuration panel
 - Go to the Audit trail tab in the configuration panel
 - Go to the Audit trail tracker settings
 - Turn audit trail on and off

6.2.7 Navigating in the User Management panel

1. Click the Configuration tab on the top bar menu.



2. Choose and click the User Management tab on the left-hand side menu, then select **Users view**.

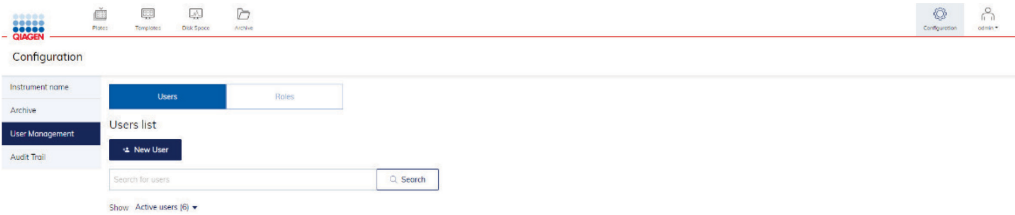

6.2.8 New user creation

All activities related to creating/editing/deactivating users can be found within the User Management tab in Users view.

Note: To read users list, permission “Read users and roles” is required. To create or edit users, additionally permission “Create and Edit Users and Roles” is required.

1. If you want to create a new user, please click the **New User** button.

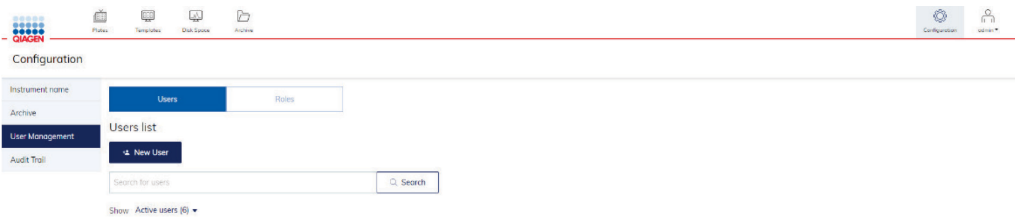

2. Fill out the form: user name (first name), surname, login, and password.

- **Note:** There is login: “System” that is reserved for special users. It cannot be selected by the Administrator when the new user is created. A warning message is shown when the Administrator tries to create user with reserved login.

 A screenshot of the 'NEW USER CREATION' form for 'John Doe'. The form is titled 'Complete user information' and has two steps: 'User information' (active) and 'Permissions'. The fields are:

- Name: john
- Surname: Doe
- Login: jdoe123
- Password: [masked with asterisks]

 At the bottom left, there is a 'Back to Users List' link, and at the bottom right, there is a 'Next' button.

3. Please remember that you can enter user login only once, and after user creation, it cannot be changed. To create a unique login, please use letters, numbers, and symbols. Minimal number of characters for login is 5.
4. When all information is filled out properly, click **Next** or **Permissions** to move to the next step.

NEW USER CREATION
John Doe

1 User Information 2 Permissions

Complete user information

Name *
John

Surname *
Doe

Login *
jdoe123

Password *

Back to Users List Next

5. In the **Permissions** (second) step, you need to choose one role that will be assigned to the user. The roles' descriptions can be found below. For detailed information about roles and permissions, you can check in the attached tables below the instruction.

NEW USER CREATION
John Doe

1 User Information 2 Permissions

Complete user permissions

Select role

Administrator Operator Lab leader Technician Group leader

Supervisor Quality Assurance

Back to Users List Back to User Information Save

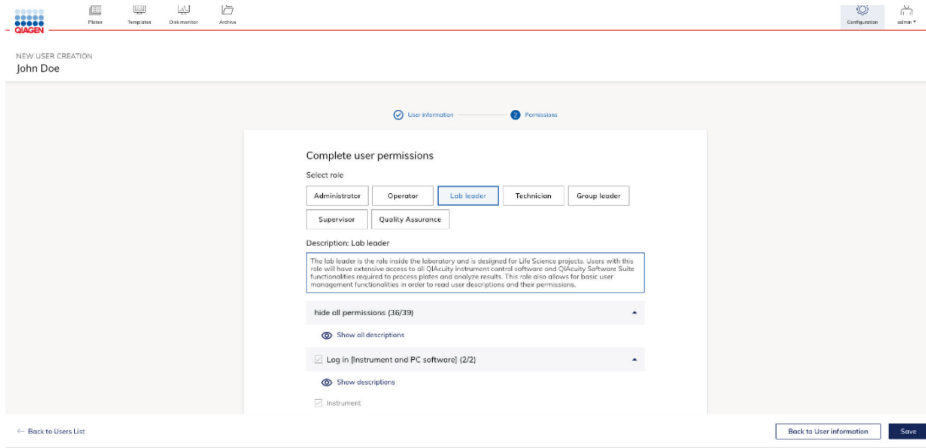

6. Please click on the selected role button.

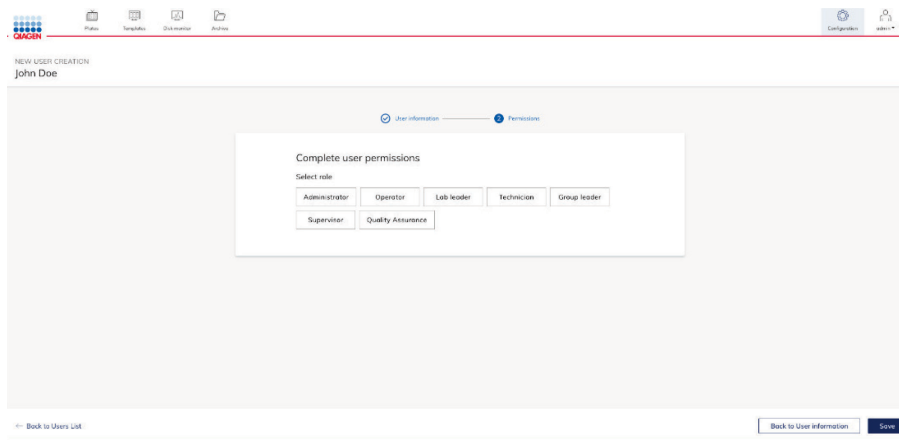

7. Read the roles' descriptions and choose the user role.

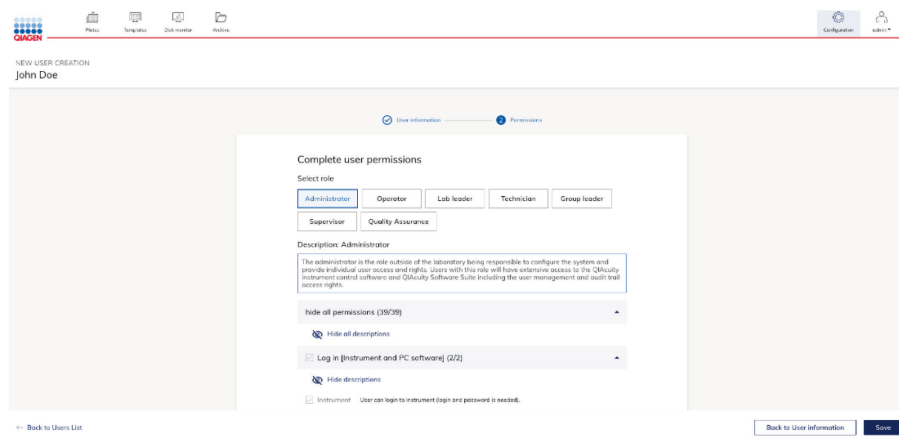

8. To see the permissions list assigned to each role, please click the **show all permissions** button below the role's description.

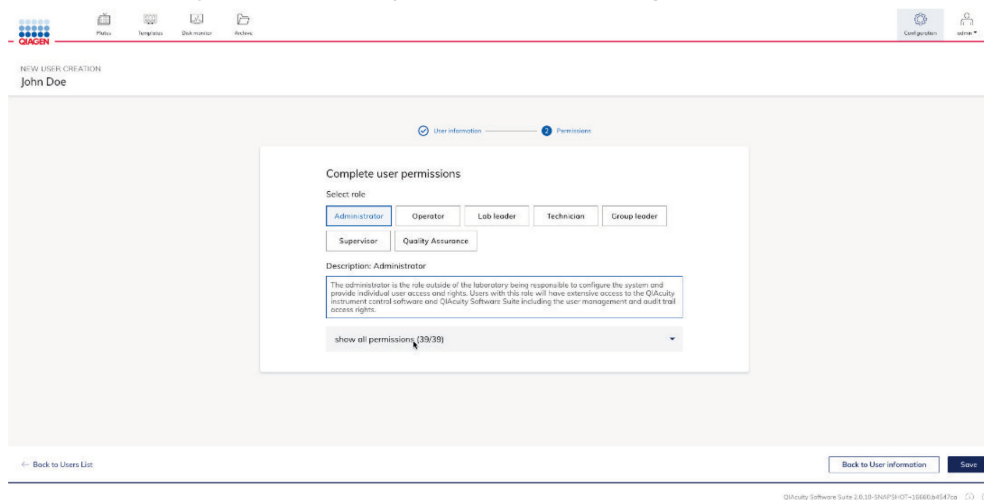

9. If you want to hide all descriptions, please click the **hide all descriptions** button.

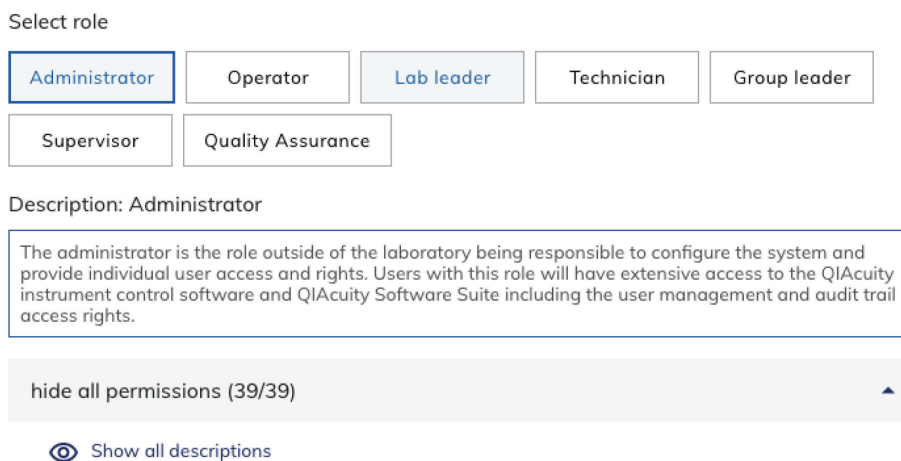

10. If you want to see the description of the permissions related to each permissions group, please click the **show all descriptions** button.

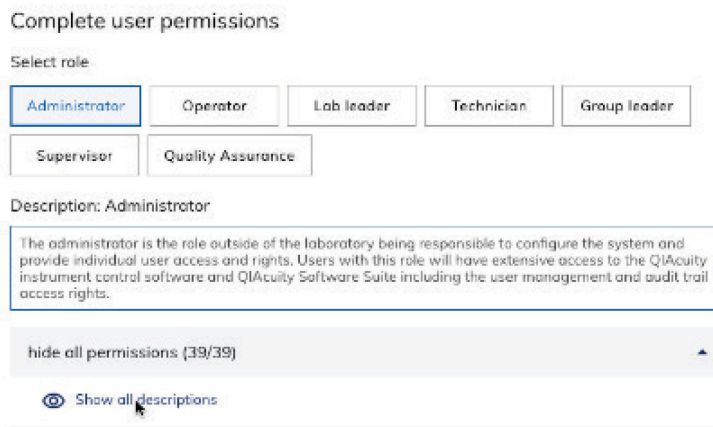

11. If you want to hide the description of the permissions related to each permissions group, please click the **Hide all descriptions** button.

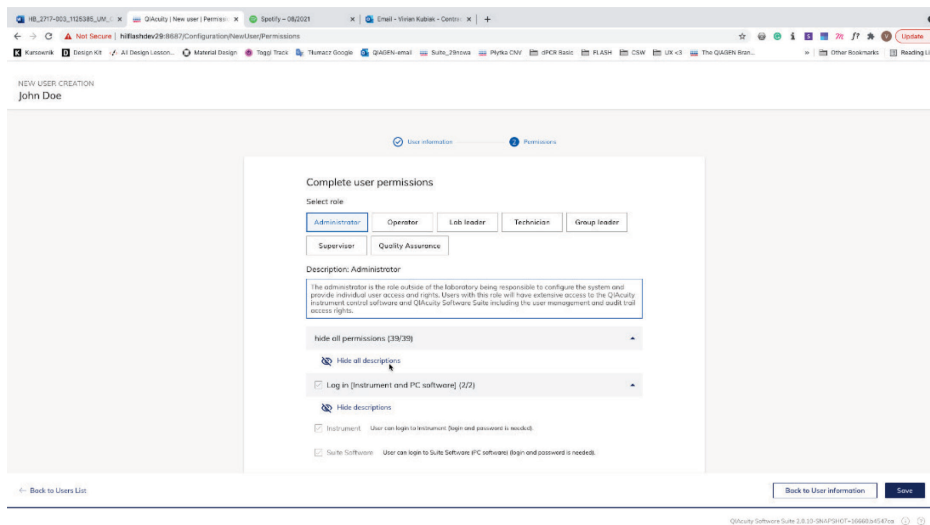

12. If you want to go back and check or change user information, please click the **Back to User Information** button or the **User information** step in the stepper.

← Back to Users List

Back to User information Save

13. Click the **Save** button to confirm and create the user.

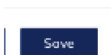

It is possible to start with the user creation process from the **Permissions** step, but entries in the **User information** step are mandatory and will be highlighted by the software (see screenshot hereafter).

1. As you can see in the picture hereafter, when you directly go to the second step, the icon from the first step, **User information**, changed and informs you that you missed the first step. In addition, you cannot save your user creation with only the second step because the user information is mandatory to fill out.

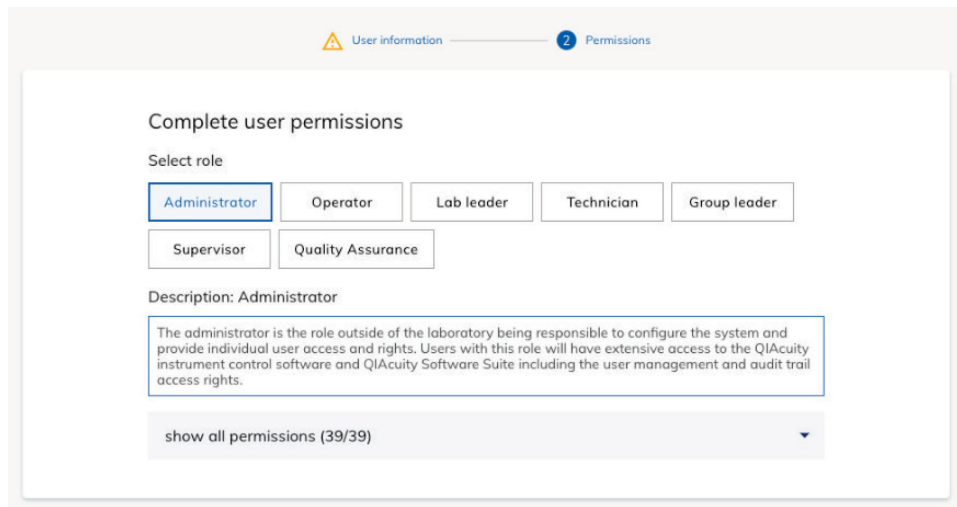

The screenshot shows the 'Complete user permissions' step. At the top, there are two tabs: 'User information' (with a warning triangle icon) and 'Permissions' (with a blue circle icon). The main content area is titled 'Complete user permissions'. Under 'Select role', there are buttons for 'Administrator', 'Operator', 'Lab leader', 'Technician', 'Group leader', 'Supervisor', and 'Quality Assurance'. The 'Administrator' button is highlighted with a blue border. Below the role selection, there is a 'Description: Administrator' section with a text box containing the following text: 'The administrator is the role outside of the laboratory being responsible to configure the system and provide individual user access and rights. Users with this role will have extensive access to the QIAcuity instrument control software and QIAcuity Software Suite including the user management and audit trail access rights.' At the bottom, there is a dropdown menu labeled 'show all permissions (39/39)'.

2. When you go back to the user information step, all mandatory input fields will become red, and you need to fill them in.

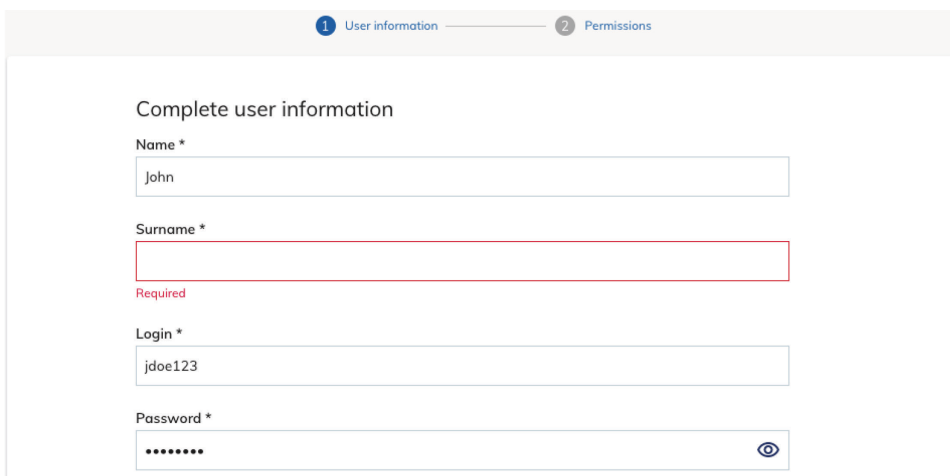

The screenshot shows the 'Complete user information' step. At the top, there are two tabs: 'User information' (with a blue circle icon) and 'Permissions' (with a warning triangle icon). The main content area is titled 'Complete user information'. There are four input fields: 'Name *' with the value 'John', 'Surname *' which is empty and has a red border and the word 'Required' below it, 'Login *' with the value 'jdoe123', and 'Password *' with a masked password '.....' and an eye icon to toggle visibility.

3. If all inputs fields are filled out, click the **Next** button.

NEW USER CREATION
John Doe

1 User information — 2 Permissions

Complete user information

Name *
John

Surname *
Doe

Login *
jdoe123

Password *

← Back to Users List Next

QIAcuity Software Suite 2.0.10-0464PS-031+10000+MS700

4. To create the user, please click the **Save** button.

NEW USER CREATION
John Doe

1 User information — 2 Permissions

Complete user permissions

Select role

Administrator Operator Lab leader Technician Group leader
Supervisor Quality Assurance

Description: Administrator
The administrator is the role outside of the laboratory being responsible to configure the system and provide individual user access and rights. Users with this role will have worldwide access to the QIAcuity instrument control software and QIAcuity Software Suite including the user management and audit trail access rights.

hide all permissions (39/39)

Hide all descriptions

Log in (Instrument and PC software) (2/2)
 Hide descriptions

Instrument User can login to instrument (login and password is needed).

← Back to Users List Back to User information Save

When you are in the user creation panel, at every moment, you can go back to the user list (by clicking the **Back to Users List** button), but please remember that all entered data will be lost.

6.2.9 Editing an existing user

To edit user data, please follow the below instructions:

1. On the users list, please find the user that you want to edit.
2. Click the **Edit user** icon.

Login	Name	Role	Status		
rholley	Robert Holley	Lab leader	Active		
techtchnician	Robert Kubica	Technician	Active		
rfranklin1234	Rosalind Franklin	Lab leader	Active		
jwatson	James Watson	Group leader	Active		
rfranklin	Rosalind Franklin	Lab leader	Active		



3. At the left-hand side are three tabs related to editing user personal data and permissions.

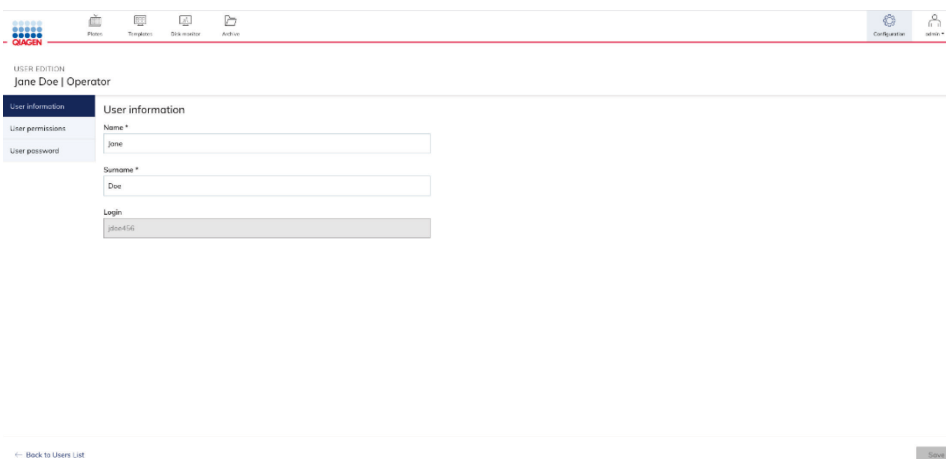

The screenshot shows the 'USER EDITION' page for 'Jane Doe | Operator'. On the left side, there are three tabs: 'User information', 'User permissions', and 'User password'. The 'User information' tab is currently selected and active, displaying the following fields:

- Name * (text input field containing 'jane')
- Surname * (text input field containing 'Doe')
- Login (text input field containing 'jdoe@G')

At the bottom left, there is a link 'Back to Users List', and at the bottom right, there is a 'Save' button.

3a. User information tab

In this tab, you can change the user name and surname, as well as check the user's login. To edit a user name or surname, please click on the input field and type in the new name/surname.

The screenshot shows the QIAGEN user management interface. At the top, there is a navigation bar with icons for Home, Templates, Data transfer, and Audit, along with Configuration and user profile icons. Below the navigation bar, the user's name 'Jane Doe | Operator' is displayed. The 'User information' tab is selected, showing a form with the following fields: Name * (Jane), Surname * (Doe), and Login (jane456). A 'Save' button is located at the bottom right of the form. A 'Back to Users List' link is visible at the bottom left.

3b. User permissions tab

In the User permissions tab, you can change the role and check the permissions description according to each role. To do it, you need to click on the new role and click the **Save** button placed at the right-hand side corner of the page.

The screenshot shows the QIAGEN user management interface. At the top, there is a navigation bar with icons for Home, Templates, Data transfer, and Audit, along with Configuration and user profile icons. Below the navigation bar, the user's name 'Jane Doe | Operator' is displayed. The 'User permissions' tab is selected, showing a 'Select role:' section with buttons for Administrator, Operator (selected), Lab leader, and Technician. Below this, there are buttons for Group leader, Supervisor, and Quality Assurance. A 'Description: Operator' section contains a text box with the following text: 'The operator is the role inside the laboratory and is designed for Life Science projects. Users with this role will have access to all general QIAcuity instrument control software and QIAcuity Software Suite functionalities required to process plates and analyze results. Deleting plates and access to the user management are restricted for these users.' Below the description, there is a 'show all permissions (25/39)' dropdown menu. A 'Save' button is located at the bottom right of the form. A 'Back to Users List' link is visible at the bottom left.

3c. User password tab

In the User password tab, you can change the user's password.

The screenshot shows the 'USER EDITION' page for 'Jane Doe | Operator'. The 'User password' tab is active. The form includes a 'New password *' field and a 'Confirm new password *' field. A 'Save' button is located at the bottom right of the form area.

On the "New password" field, you need to enter the new password. On the "Confirm password", you need to re-enter the same password as in the "New password" field. Those passwords should be the same. If the passwords you entered matched, please click the **Save** button.

This screenshot shows the same 'User password' form as above, but the input fields are now filled with asterisks, indicating that the user has entered a password. The 'Save' button at the bottom right is now highlighted in blue.

Then, click the **OK** button to save the changes.

The screenshot shows a 'Save changes?' dialog box overlaid on the 'User password' form. The dialog box contains the text 'Are you sure you want to edit user and save changes?' and two buttons: 'Cancel' and 'OK'.

6.2.10 User deactivation

Users with Administrator role are able to deactivate other users to restrict access to the system for such users.

Note: It is not possible to delete users.

1. Find the user you want to deactivate.
2. At the end of the row, please find **the deactivate user** icon and click it.

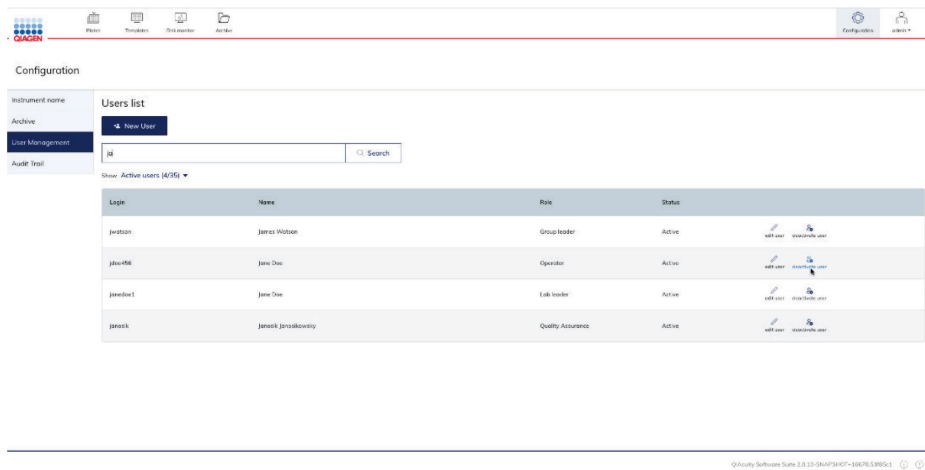

The screenshot shows the 'Users list' interface in the QIAGEN software. The interface includes a navigation menu on the left with options like 'Plates', 'Templates', 'Disposables', and 'Anchors'. The main content area displays a table of users with columns for 'Login', 'Name', 'Role', and 'Status'. Each row has a 'deactivate user' icon (a person with a red X) at the end. The table lists four users: James Watson (Group leader), Jane Doe (Operator), Jane Doe (Lab leader), and Janek Jankiewicz (Quality Assurance). A search bar and a 'New User' button are also visible.

Login	Name	Role	Status	
jwatson	James Watson	Group leader	Active	
jdoo188	Jane Doe	Operator	Active	
jdoo181	Jane Doe	Lab leader	Active	
jankew	Janek Jankiewicz	Quality Assurance	Active	

3. Read the text in the pop-up window.

Deactivate the user?

After deactivation, all Plates and Templates created by the user will still be visible for other members.

The user account will be disabled but not removed. You will be able to reactivate the user profile.

Are you sure you want to deactivate the user?

Cancel

Yes

- Please remember that after the user is deactivated, all Plates assigned to this user will not use the Owner but show them in plate owner as deactivated. If you activate the user again, Plate Ownership will be reassigned.
- Click the **Yes** button to deactivate the user.

6.2.11 User activation

Deactivated users may still be activated by users with “Activate and Deactivate User” permission to restore their access to the system.

- In the Users list tab, find the **Show** sorting button.

The screenshot shows the 'Users list' tab in the software interface. The 'Show' dropdown menu is open, displaying 'Active users (4/35)' as the selected option. The table below lists four active users:

Login	Name	Role	Status
jabrown	James Watson	Group leader	Active
jb0456	Jane Doe	Operator	Active
jabrown1	Jane Doe	Lab leader	Active
jabrown	James Watson	Quality Assurance	Active

- Change the option to **Deactivated users**.

The screenshot shows the 'Users list' tab in the software interface. The 'Show' dropdown menu is open, displaying 'Deactivated users (0/0)' as the selected option. The table below lists four deactivated users:

Login	Name	Role	Status
jabrown	James Watson	Group leader	Deactivated
jb0456	Jane Doe	Operator	Deactivated
jabrown1	Jane Doe	Lab leader	Deactivated
jabrown	James Watson	Quality Assurance	Deactivated

The Users list table shows all deactivated users.

3. Please find the user you want to activate.
4. Click the **activate user** icon.

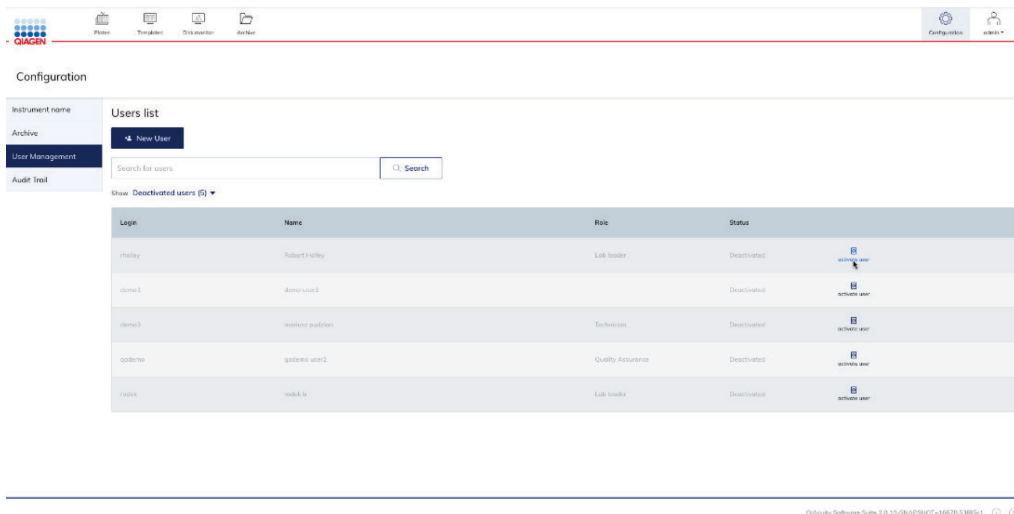

5. Read the text in the pop-up window. If you are sure you want to activate the user, click the **Activate** button; if not, please click the **Cancel** button.

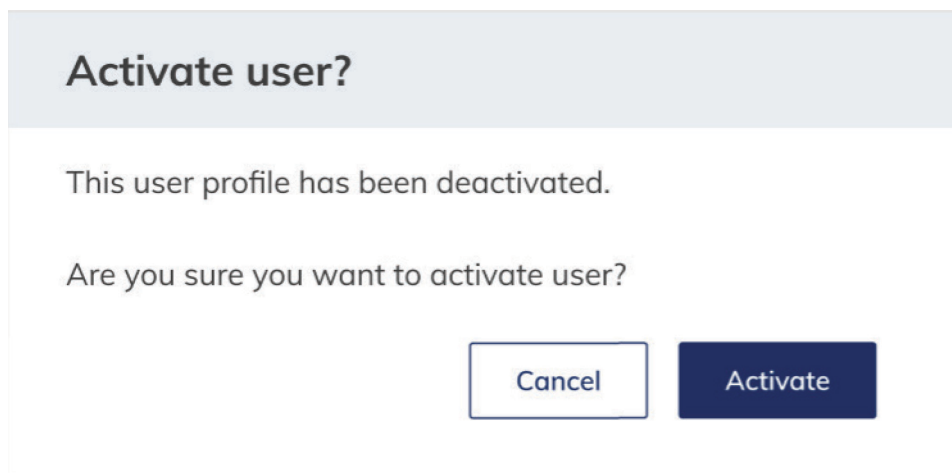

6. If you click the **Activate** button, you can find the user under the "Active" and "All" Users list.

6.2.12 New role creation

All activities related to creating/editing/deleting roles and list of existing roles can be found within the **User Management** tab in Roles view.

Note: To read roles list, permission “Read users and roles” is required. To create or edit users, additional permission “Create and Edit Users and Roles” is required.

1. If you want to create a new role, please click the **New Role** button.

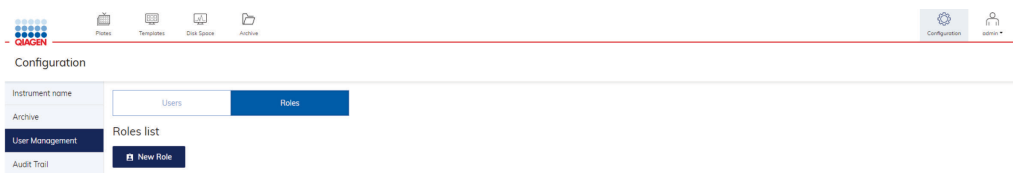

2. Fill out the form: role name and role description.

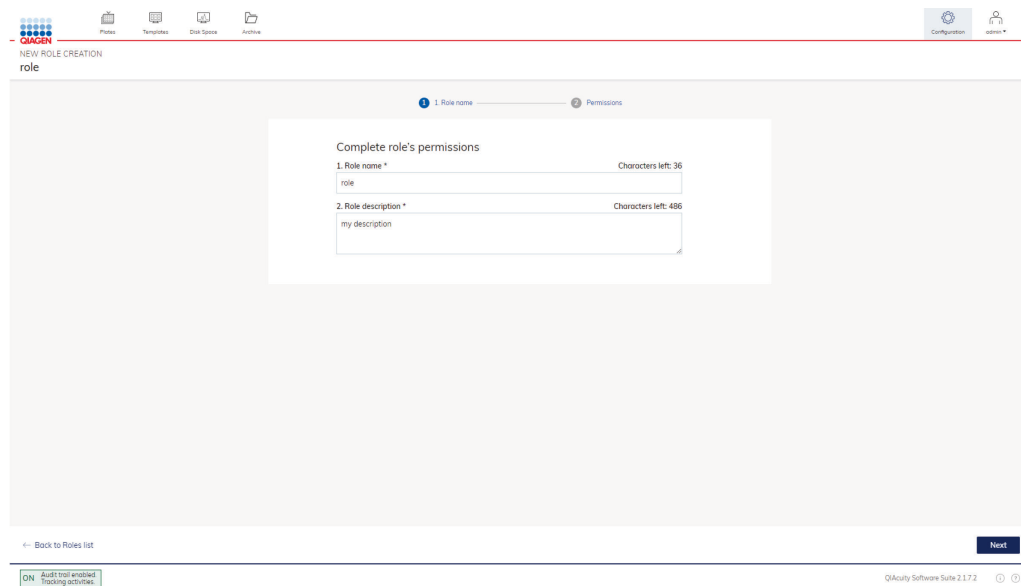

3. When all information is filled out properly, click **Next** or **Permissions** to move to the next step.
4. In the **Permissions** (second) step, you need to choose permissions which will be assigned to the role. To speed up selection, you can use predefined roles as templates and adjust permission to your needs and save as new role. Every permission has its own description that could be shown or hidden similarly as for users creation/editing. Some of permissions also have some useful notes, for example, which permissions should be selected together.

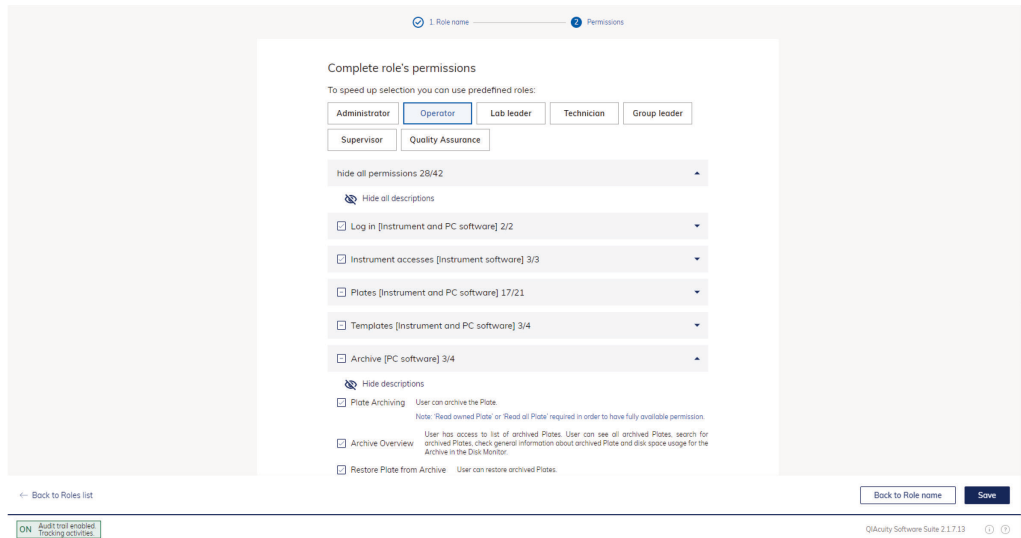

5. If you want to go back and check or change role name, please click the **Back to Role name** button or the **Role name** step in the stepper.

← Back to Roles list

Back to Role name Save

6. Click the **Save** button to confirm and create the role.

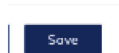

Note: All entries need to be completed under **Role name** before moving to the Permission step. The software will indicate any missing information in the **Role name** step. In case you have entered any information under Permissions before having completed all required entries under **Role name**, all entries will be lost when you hit the **Back to Role name** button.

Note: Creation of a new role need to be completed by pressing the **Save** button. Otherwise, all changes will be lost in case you press **Back to Roles list**.

From the **Roles** list, you can check permissions by pushing the **Permissions list** button.



Permissions list - Lab_role



hide all permissions 27/42 ▲

 Hide all descriptions

Log in [Instrument and PC software] 2/2 ▲

 Hide descriptions

Instrument User can login to Instrument (login and password is needed).

Suite Software User can login to Suite Software (PC software) (login and password is needed).

Instrument accesses [Instrument software] 2/3 ▼

Plates [Instrument and PC software] 17/21 ▼

Templates [Instrument and PC software] 3/4 ▼

Archive [PC software] 3/4 ▼

User Management [PC software] 0/4 ▼

System configuration [PC software] 0/4 ▼

Close

Pressing the **Users list** button will bring you to the list of all users and their status.



users list

Lab_role - Users list



User name

User login

Status

1. John Smith

jsmith

Active



Close

6.2.13 Editing existing role

Note to edit role, you need "Create and Edit Roles" permission. Only roles created by User can be edited. Predefined roles cannot be edited.

To edit role, please follow the below instructions:

1. On the roles list, please find the role that you want to edit.
2. Click the **edit role** button.

The screenshot shows the QIAcuity Configuration interface. The top navigation bar includes icons for Roles, Templates, Disk Space, Archive, Configuration, and Admin. The main content area is titled "Configuration" and has a sidebar with "Instrument name" (Users, Roles), "Archive", "User Management", and "Audit Trail". The "Roles list" section is active, showing a table of roles with columns for Role name, Created by, Creation date, and Assigned users. The table lists roles such as Lab_role, TestRoleMkt, Quality Assurance, Supervisor, Group leader, Technician, Lab leader, Operator, and Administrator.

Role name	Created by	Creation date	Assigned users	Actions
Lab_role	User	25/03/2022	0	permissions list, users list, edit role, delete role
TestRoleMkt	User	25/03/2022	0	permissions list, users list, edit role, delete role
Quality Assurance	Predefined	24/03/2022	0	permissions list, users list
Supervisor	Predefined	24/03/2022	0	permissions list, users list
Group leader	Predefined	24/03/2022	0	permissions list, users list
Technician	Predefined	24/03/2022	0	permissions list, users list
Lab leader	Predefined	24/03/2022	0	permissions list, users list
Operator	Predefined	24/03/2022	0	permissions list, users list
Administrator	Predefined	24/03/2022	1	permissions list, users list



edit role

3. At the left-hand side are two tabs related to role information and role permissions.

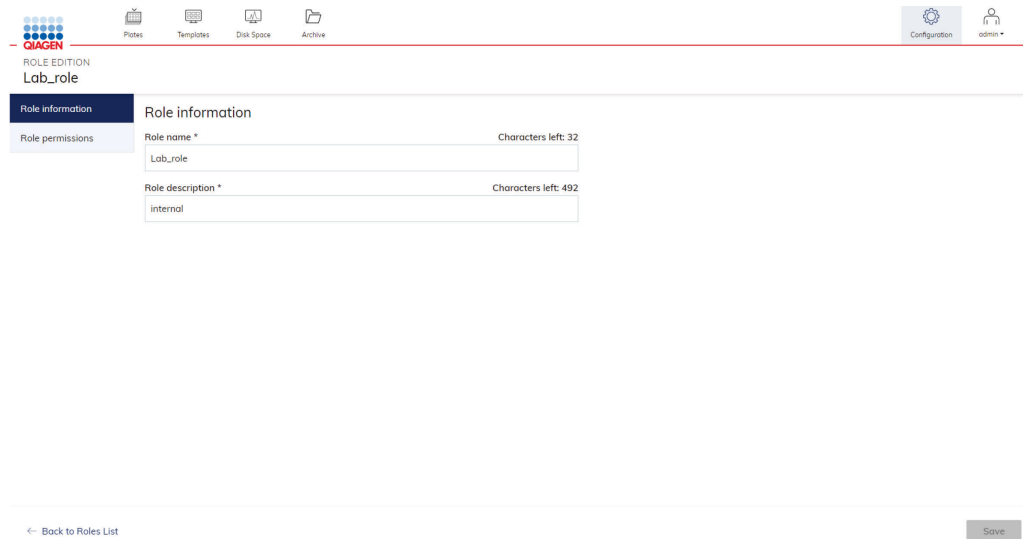

QIAGEN

Photos Templates Disk Space Archive

Configuration admin

ROLE EDITION
Lab_role

Role information

Role permissions

Role name * Characters left: 32
Lab_role

Role description * Characters left: 492
internal

← Back to Roles List

Save

3a. Role information tab

In this tab, you can change the role name and description. To edit a user name or surname, please click on the input field and type the new value.

3b. Role permissions tab

In the Role permissions tab, you can change permissions assigned to role. To do it, you need to select permissions using checkboxes and click the **Save** button placed at the right-hand side corner of the page.

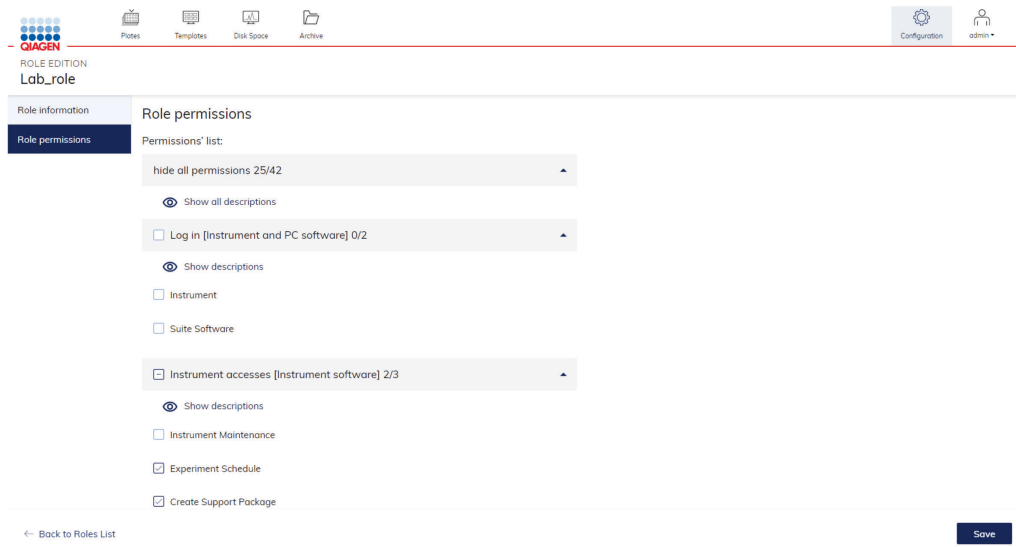

3c. In case when some users have been assigned to role you are modifying after pressing **Save** button, you will be presented with window informing how many users will be impacted and you can check impacted users list using drop-down list.

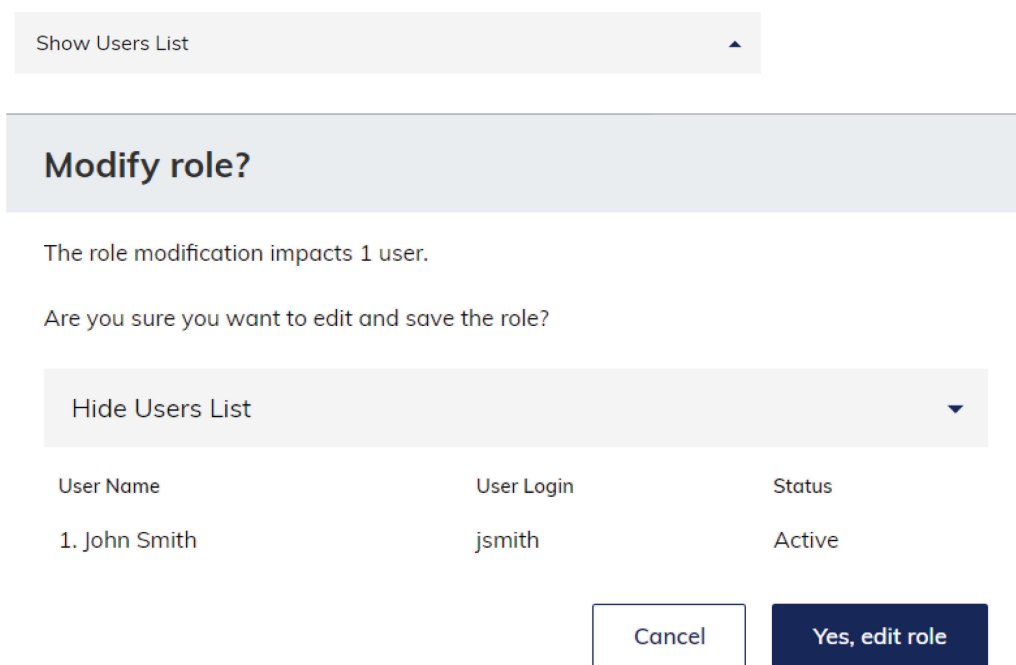

3d. To confirm your changes click **Yes, edit role** button.

In case when no users have been assigned to role you are modifying, confirmation window is not presented.

6.2.14 Role deletion

Note to delete role you need "Delete role" permission. Predefined roles cannot be deleted. Only roles created by User with no users assigned can be deleted.

To delete role, please follow the instructions below:

1. On the roles list, please find the role that you want to delete.

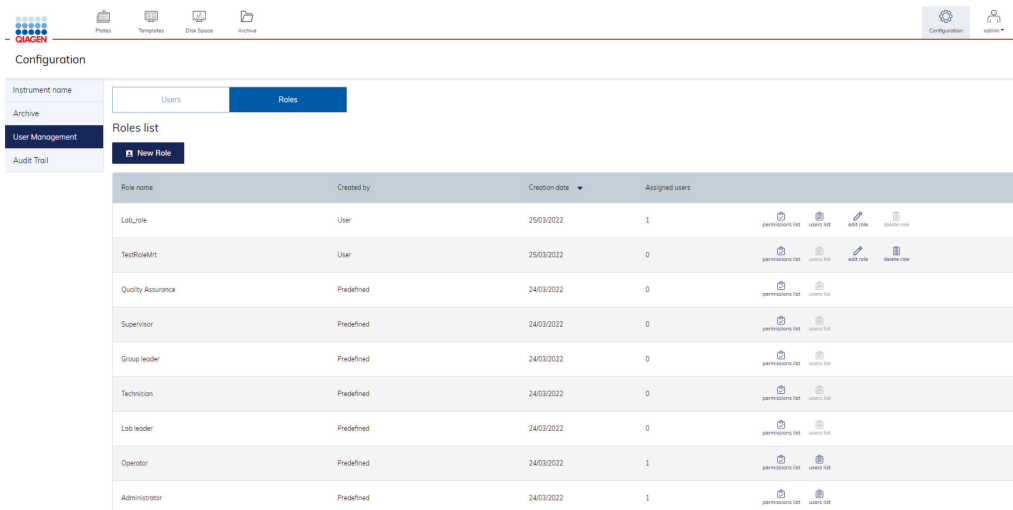

The screenshot shows the QIAGEN Configuration interface. The top navigation bar includes icons for Home, Templates, Disk Space, Archive, Configuration, and Admin. The left sidebar contains links for Instrument name, Archive, User Management, and Audit Trail. The main content area is titled "Roles list" and features a "New Role" button. Below the button is a table with the following data:

Role name	Created by	Creation date	Assigned users	Actions
Lab role	User	25/03/2022	1	permissions list, users list, edit role, delete role
TestRoleMT	User	25/03/2022	0	permissions list, users list, edit role, delete role
Quality Assurance	Predefined	24/03/2022	0	permissions list, users list
Supervisor	Predefined	24/03/2022	0	permissions list, users list
Group leader	Predefined	24/03/2022	0	permissions list, users list
Technician	Predefined	24/03/2022	0	permissions list, users list
Lab leader	Predefined	24/03/2022	0	permissions list, users list
Operator	Predefined	24/03/2022	1	permissions list, users list
Administrator	Predefined	24/03/2022	1	permissions list, users list

2. Click the **delete role** button.

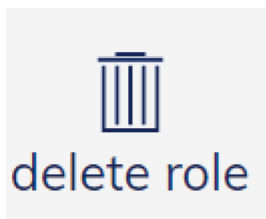

Note: If they are users assigned to role, the above button become inactive (grey) and tooltip is presented.

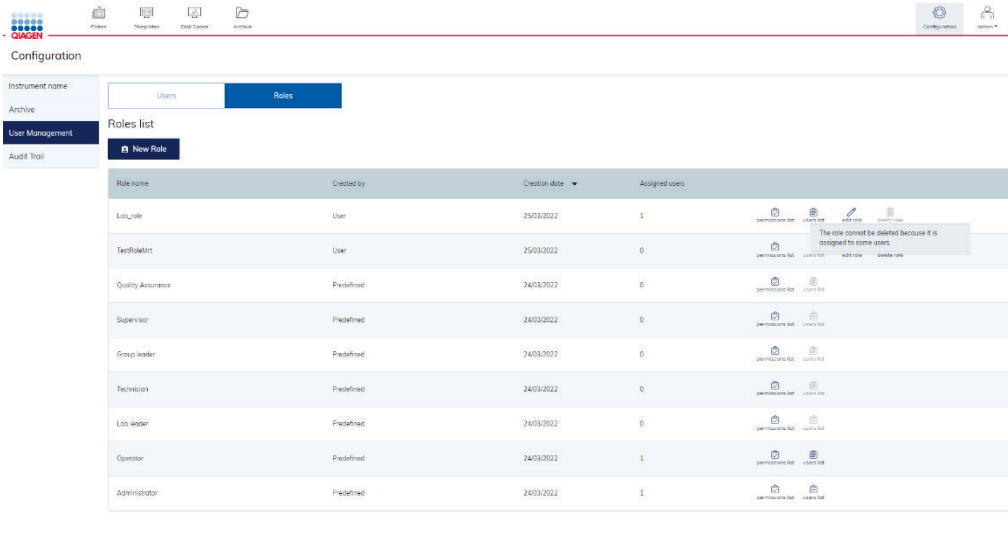

6.2.15 Plate ownership

Plate Ownership allows users to assign one or more users to a specific Plate. A user who creates a new Plate, imports a plate, or restores a plate from the Archive is assigned automatically as an owner of the plate.

Note: For imported or restored plates, the operating user will automatically be added as plate owner if no plate owner is already assigned to the plate or if the assigned plate owner is a deactivated owner. For upgraded plates, owners from original plate will be preserved if they exist in the current QIAcuity Soft Suite; otherwise, the operating user will be set as plate owner.

6.2.16 Assigning the owner of the plate

1. On the **Plates** tab (Plates Overview), please find the Plate that you want to assign the owner.

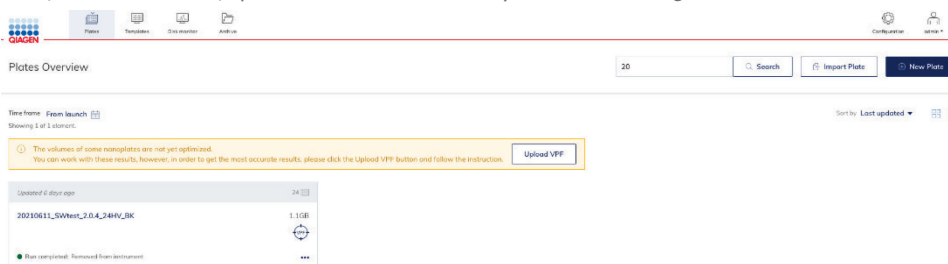

2. Choose the Plate from Plates Overview.
3. In the **General Data** tab, you can find the "Plate Ownership" field (below "Labels").

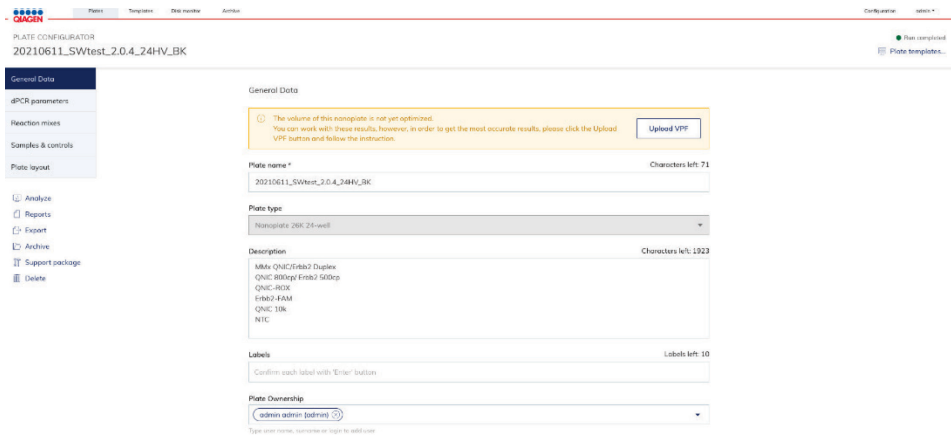

4. Click on the “Plate Ownership” input field.



5. Start writing the user name/surname/login.



6. Choose the user from drop-down list by clicking the chosen name.



7. User has been added.

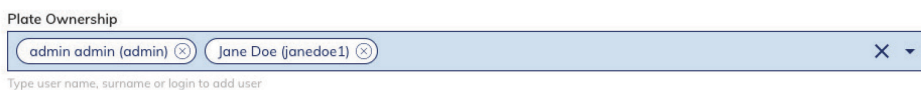

8. If you want to add another user, start writing the user name/surname/login. Then, choose the user from the drop-down list.

9. Please click the **Done** button to save changes.



6.2.17 Removing an owner of the plate

1. If you want to remove one owner of a Plate, click the close icon placed within the user name tag.



2. If you want to remove all owners, click the clear icon on the end of the input field.



6.2.18 Log-in screen

The main toolbar shows which user is currently logged-in. To view more information about the user, click the icon.

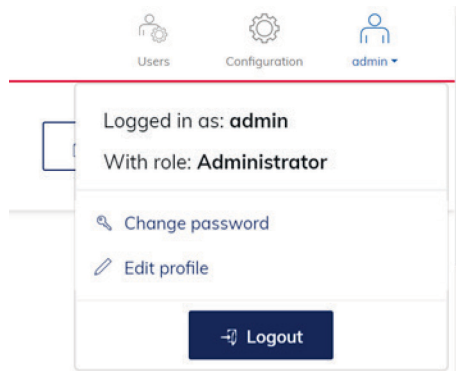

The user can change the password, edit the user profile, and log out.

1. To change the password, click **Change password**. The Change user password dialog box appears.

2. Enter the current password in the **Current password** field and the new password in the **New password** field. In the **Confirm password** field, enter the same password you specified in the **New password** field. Click **Save** to change the password.

3. To edit the user profile, click **Edit profile**. The Edit User profile dialog box appears.

Edit user profile

Name * Characters left: 30

Surname * Characters left: 30

4. Enter a new name in the **Name** field and surname in the **Surname** field. Click **Save**.
5. To log out, click **Logout** to return to the home screen of the QIAcuity Software Suite.

6.3 Audit trail

The Audit trail is a functionality in the QIAcuity Software Suite, which supports users meeting Good Manufacturing Practice (GMP)/Good Laboratory (GLP) regulations. The default setting of the QIAcuity Software Suite is the Audit trail tracker switched on. This functionality may be switched off by an Administrator if the QIAcuity systems are not operated in a GMP/GLP lab.

Important: The audit trail may only be switched off when GMP compliance is not required, for example, in molecular biology (MBA) labs. There is no data (events) stored and displayed when the tracker is turned OFF. In GMP environments, this toggle **must not be** set to OFF to maintain 21 CFR Part 11 compliance support.

When switched on, the Audit Trail records all actions that happened in the system. Each record consists of the following:

- time stamps (day, month, year, hour)
- user login that initiated the event that happened in the system
- category of the event (Instrument, Suite, or Plate)
- event type, what/who was affected by the action (Plate ID, User login, or Instrument ID)
- description of details after a change in table format

6.3.1 Audit trail tracker settings

To turn the Audit trail tracker ON/OFF, on the main toolbar, click the Configuration tab.



On the left-hand side, you can see the tabs menu. Click on the Audit Trail tab.

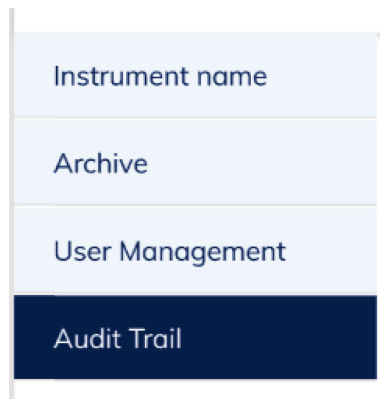

On the center of the page is the second tabs menu panel. Click the Audit trail tracker settings tab.

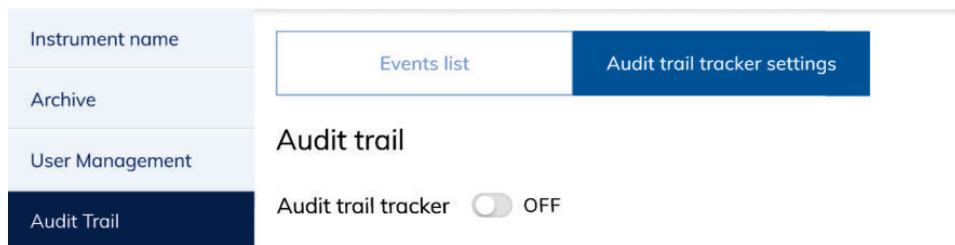

As shown below, the Audit trail tracker is turned off when the circle is at the left-hand side, the toggle is gray, and an "OFF" label appears at the right-hand side.

Audit trail

Audit trail tracker OFF

To turn the tracker ON, click on the toggle.

When the Audit trail tracker is turned on, the circle is at the right-hand side, the toggle is blue, and an "ON" label appears at the right-hand side.

Audit trail

Audit trail tracker ON

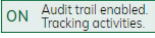
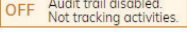
Moreover, there is additional indicator in the footer, bottom left corner of the application, informing about the selected option. If the Audit trail tracker is ON, the following indicator is displayed ; else if it is OFF, then  is displayed.

6.3.2 Events List

Events list table

The events list shows all events (logs) that happened in the system. There is no possibility to remove an event from the system by the User or Administrator.

To display the Events list, on the main toolbar, click the **Configuration** tab.



At the left-hand side, you can see the tabs menu. Click the **Audit Trail** tab.

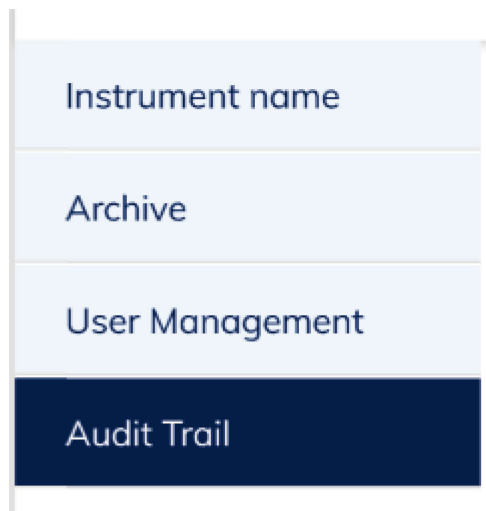

After clicking the **Audit Trail** tab, the following tab menu panel will appear. Click the **Events list** tab.



Below the filters, you can find the Events list from the past months.

The Events list is sorted chronologically, from the newest events to the oldest.

Date and time	Initiated by User Login	Category	Event type	Affected Plate ID / User login	Instrument ID	
07/07/2021 08:17:49	admin	Suite	Audit trail toggle			-42 check details
07/07/2021 08:17:46	admin	Plate	Delete plate	74e46136-0e63-4f8d-bd6d-38c9505572e5 (Plate ID)		-43 check details
07/07/2021 08:17:42	admin	Suite	Audit trail toggle			-42 check details
06/07/2021 08:05:01	admin	Suite	Audit trail toggle			-42 check details
05/07/2021 15:29:57	admin	Plate	Support package download	3934434-7091-4c5d-8142-8c59590ca46a (Plate ID)		-43 check details
05/07/2021 14:50:47	admin	Plate	Plate experiment change	5815981d-154a-47a1-9726-d6c17b889f55 (Plate ID)		-43 check details
05/07/2021 14:49:01	admin	Plate	Plate experiment change	3934434-7091-4c5d-8142-8c59590ca46a (Plate ID)		-43 check details
05/07/2021 14:39:55	admin	Plate	Plate experiment change	1ad75466-ea479-4152-e660-c2c421509a42 (Plate ID)		-42 check details

To find a specific event, you can scroll the list down or use the following filters.

Start date *

End date *

Search for Instrument ID, affected Plate ID, user login

Category

Event type

Initiated by

6.3.3 Search

Search for Instrument ID, affected Plate ID, and user login

You can search for Instrument ID number, affected Plate ID, or affected user login. Click on the search field: “Search for Instrument ID, affected Plate ID, user login”.



Search for Instrument ID, affected Plate ID, user login

Input your query. After a few seconds, the records on the events list will be updated automatically (example of Plate ID number: **b0bd01c1-0c6d-4377-b030-677f12711831**, example of instrument ID number: **QIAcuity-00617**).

6.3.4 Filters

Filter by specific date or specific time frame

If you want to find all events that happened in one specific day or time period, you need to use the filters “Start date” and “End date”.

Start date *	End date *
<input type="text" value="25/04/2022"/> 	<input type="text" value="25/05/2022"/> 

Click on the “Start date” input field or click the calendar icon.

Start date *

Set the date that are you interested in from the calendar.

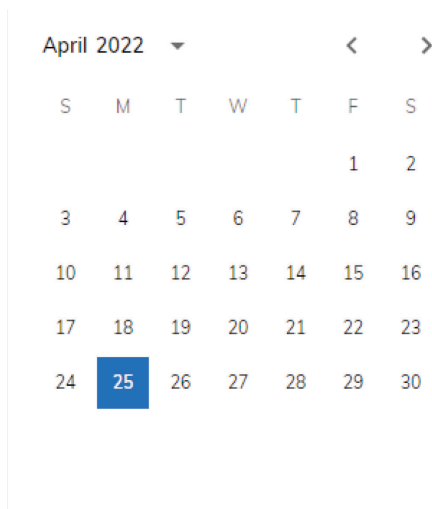

Then specify “End date” in similar manner. **Note:** You can select the same day as in “Start date” to filter only a single, specific day. Afterwards, the records on events list will be updated automatically.

Filter: Category

You need to use the “Category” filter to check all data related to one specific category (Instrument, Software Suite, or Plate). Category refers to device/tool: Instrument, Suite (PC Software), or Plate, on which the action has been taken.

- Instrument – all events related to the instrument
- Suite – all events that happened on the QIAcuity Software Suite (PC software)
- Plate – all events related to Plates

Use the “Category” filter.

Category

Click the drop-down arrow to view the three category options.

- Suite/Instrument/Plate
- Instrument
- Plate
- Suite

Select only one option from drop-down list: Instrument, Plate, or Suite.

Category

Afterwards, the records list will be updated automatically.

Date and time	Initiated by User Login	Category	Event type	Affected Plate ID / User login (Plate ID)	Instrument ID
07/07/2021 08:17:46	admin	Plate	Delete plate	74e6336-0d83-45b8-b8c8-38b950572e6 (Plate ID)	+0 (check details)
06/07/2021 01:00:05	system	Plate	Archive plate	25a8e277-607b-4a6c-9a20-ed0abed31c2f4 (Plate ID)	+0 (check details)
06/07/2021 01:00:05	system	Plate	Archive plate	86c0f009-256c-4ba4-9d72-b7411a55e9b2 (Plate ID)	+0 (check details)
06/07/2021 01:00:05	system	Plate	Archive plate	388ba7da-0034-4526-b4c3-e9651e7f4f7 (Plate ID)	+0 (check details)
06/07/2021 01:00:05	system	Plate	Archive plate	b4d4b682-4682-4009-8c4d-0735b8883a90 (Plate ID)	+0 (check details)

Filter: Event type

Event type refers to the action that happened in the system on the Instrument, Suite (PC software), or Plate. If you don't choose any option from the category, the filter displays a list of all event types (a sum of events type from all the three categories).

List of possible events: Plate experiment finish, User unlock plate, Archive plate, Restore plate, Import plate, Export plate, Support package download, Barcode removal, Instrument registration, Calibration, Plate schedule update, Experiment run (plate), Experiment canceled, Support package created, Update started, Drawer opening/closing during run, Clear error, Audit trail toggle, Archive configuration create, Archive configuration update, Archive configuration delete, Archive configuration schedule, Upload VPF, Apply VPF, Delete template, Update template, Create template, Create report, Delete report, Sign report, System version change, Create user, Edit user, Change password, User activation, User deactivation, Log on - success, Log on - failure, Log off, Automatic log off, Role creation, Role edition, Role deletion, Create plate, Update plate, Delete plate, Upgrade plate, Plate upgrade failed, Plate experiment change.

Note: The event type depends on the selected category. After filtering for a category, the event type list will only show event types related to the chosen category.

Use the "Event type" filter.

Event type

Click the arrow icon and choose one option from the drop-down list.

Event type

Afterwards, the records list will be updated automatically.

Date and time	Initiated by User Login	Category	Event type	Affected Plate ID / User login (Plate ID)	Instrument ID
01/07/2021 13:12:42	admin	Plate	Update plate	393c434-7691-4c5d-8142-8c59390a86a (Plate ID)	-43 check details
01/07/2021 08:46:50	admin	Plate	Update plate	76656aa4-8282-4914-9e8a-446d7312c594 (Plate ID)	-43 check details
30/06/2021 15:18:06	admin	Plate	Update plate	6ac7c01-0285-4044-b043-4bc8b951c8ba (Plate ID)	-43 check details
30/06/2021 15:15:40	admin	Plate	Update plate	76656aa4-8282-4914-9e8a-446d7312c594 (Plate ID)	-43 check details
30/06/2021 15:15:17	admin	Plate	Update plate	76656aa4-8282-4914-9e8a-446d7312c594 (Plate ID)	-43 check details
30/06/2021 14:10:36	admin	Plate	Update plate	76656aa4-8282-4914-9e8a-446d7312c594 (Plate ID)	-43 check details

Filter: Initiated by

The filter “Initiated by” is related to a person (search for user login) that performed actions in the system. Login is unique and cannot be duplicated, so filtering for it will provide the user specific results.

Initiated by



The filter interface consists of a light blue rounded rectangle containing two search boxes. The first search box contains the text 'admin' and the second contains 'user1'. Both boxes have a small 'x' icon to their right. To the right of the search boxes is a larger 'x' icon for clearing the filter, and a downward-pointing triangle icon for a dropdown menu.

This filter allows you to even search for multiple users.

6.3.5 Check details

In the Events list, you can find the last option in the row, which is **check details**. Click it.

Events (17/17)

Date and time	Initiated by User Login	Category	Event type	Affected Plate ID / User login (Plate ID)	Instrument ID
01/07/2021 13:12:42	admin	Plate	Update plate	393c4c14-7691-4c5d-8142-4c59930a466a (Plate ID)	+H2 check details
01/07/2021 08:46:50	admin	Plate	Update plate	76656aa4-8282-4914-9e8a-446af32c5994 (Plate ID)	+H2 check details
30/06/2021 15:18:06	admin	Plate	Update plate	6cccf01f-1285-4044-b043-48c8b957c96a (Plate ID)	+H2 check details
30/06/2021 15:15:40	admin	Plate	Update plate	76656aa4-8282-4914-9e8a-446af32c5994 (Plate ID)	+H2 check details
30/06/2021 15:15:17	admin	Plate	Update plate	76656aa4-8282-4914-9e8a-446af32c5994 (Plate ID)	+H2 check details
30/06/2021 14:10:36	admin	Plate	Update plate	76656aa4-8282-4914-9e8a-446af32c5994 (Plate ID)	+H2 check details

The **check details** option allows you to see all detailed changes that happened in the system. Changes are displayed as a table.

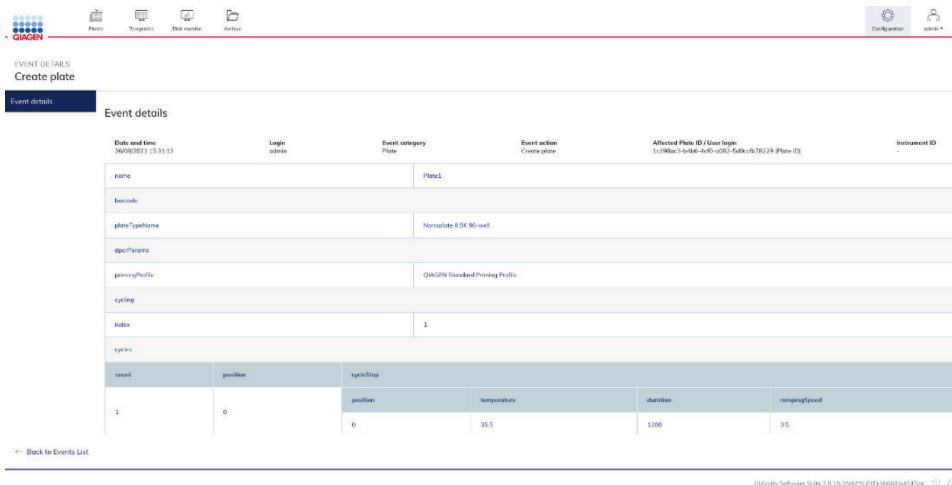

The screenshot shows the 'Event details' page for a 'Create plate' event. The page has a navigation bar at the top with icons for Home, Templates, Data monitor, and Action. Below the navigation bar, there are tabs for 'Event details' and 'Event status'. The 'Event details' tab is active, showing a table of parameters and a table of event data.

Date and time	Login name	Event category	Event action	Affected Plate ID / User login	Instrument ID
30/06/2021 15:31:53	admin	Plate	Create plate	11298ac3-b346-4d9f-cd82-6d0c7b761279 (Plate ID)	-

name	value
name	Plate1
seconds	
plateTypeName	Nonplate 8.5K 96-well
appParams	
printingProfile	QIAGEN Standard Printing Profile
coding	
index	1
extra	

start	position	spinStep	position	temperature	duration	rotatingSpeed
1	0	0	35.5	1200	35	

Back to Events List

QIAGEN Software Suite 2.6.10-SNAPSHOT-10741066034547ea

6.3.6 Exporting to PDF

All event details can be exported to a PDF file.

1. Click on the Audit trail Events list tab.



2. Apply filters to select for those events that should be exported.
3. At the right-hand side, above the Event list, you can find the **Export to PDF** option. Click on it.

A screenshot of a table titled "Events (3/5)". The table has columns: "Date and time", "Initiated by User login", "Category", "Event type", "Affected Plate ID / User login", and "Instrument ID". A row of data is visible. To the right of the table is an "Export to PDF" button with a document icon. Below the table, there is a link "check details" with a right-pointing arrow.

Date and time	Initiated by User login	Category	Event type	Affected Plate ID / User login	Instrument ID
09/12/2021 08:45:12	rfranklin	Instrument	Instrument registration	1ed75d4b-0478-4152-a6b0-d2e421b59f62 (Plate ID)	90876480

4. Afterwards, a PDF file will be exported and downloaded.

6.3.7 General software use

Entering data

These shortcut functions are available in QIAcuity Software Suite:

Table 10. Shortcut functions in QIAcuity Software Suite

Shortcut Function	Use
Ctrl + C	Copy
Ctrl + V	Paste
Tab and arrow keys	Navigate from one field to another

Displaying errors, warnings, and additional information

The QIAcuity Software Suite displays errors, warnings, and additional information messages throughout the experiment to prompt the user to perform a required action.

Table 11. Messages displayed in QIAcuity Software Suite

Priority level	Type	Color	Description	Required action from user
1	System error	Red	Combination of events requiring an action	User interaction required
2	Warning	Yellow	Situation could be optimized by further input	User interaction not required, but possible
3	Information	Gray	Message containing additional information about the current situation	No user interaction required

System error

In case of a system error, a red text box appears to describe the error and inform you of the required action. You must perform the required action described in the system error to proceed with the next step.



Warning message

A warning message is displayed in yellow in case further optimization of the experimental setup is recommended. A user interaction is not required to proceed with this step.

Channel *

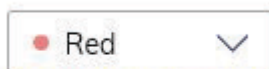

Recommended channel for the selected dye is: Orange

Information message

At certain fields in the experiment, you can view additional information regarding the required data to be entered on a field. Fields with information messages are marked with  icon. Clicking this icon displays a text box that provides additional information about the data needed in the field. No user interaction is required to proceed with this step.

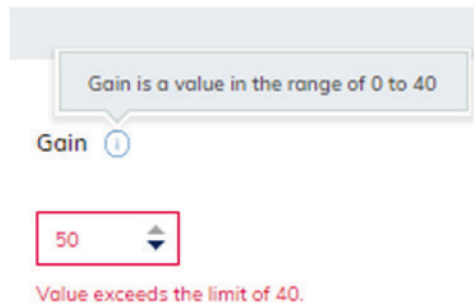

6.4 Setting up an experiment

This section provides information about the steps required to set up a new experiment:

6.4.1 Creating a new plate

1. Click **Plates** in the main toolbar to enter the plates environment.

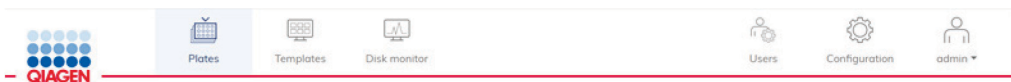

2. Click **New Plate**.



3. Refer to Table 12 to provide the following required information in each tab:

General Data
dPCR parameters
Reaction mixes
Samples & controls
Plate layout

Table 12. Required steps in creating a plate

Tab	Steps
General data	Enter the basic information about the plate: <ul style="list-style-type: none"> • Plate name • Plate type • Description • Labels • Plate ownership • Barcode
dPCR parameters	Specify the following information: <ul style="list-style-type: none"> • Priming profile • Cycling • Imaging
Reaction mixes	Provide the following information for a new reaction mixes: <ul style="list-style-type: none"> • Reaction mix name • Color • Target Name • Dye • Channel
Samples & Controls	Specify the following information for a new sample: <ul style="list-style-type: none"> • Sample name • Labels • Amount • Description • Specify the following information for a new control: • Control name • Specify the following information for a new non-template control • Non Template Control name
Plate layout	Provide the following information: <ul style="list-style-type: none"> • Add reaction mix • Mark as blank • Add sample • Add control • Add NTC

6.5 Defining general data

In the **General Data** tab, you can specify the basic information about the plate. Mandatory input fields are marked with an asterisk. The plate name is required to save a plate.

Note: Please make sure that selected Plate type corresponds with the entered barcode, if manually entered. If not matching, it will lead to error on the instrument (error 205).

Table 13. General data tab

Field	Field Help
Plate name	Specify the name of the plate.
Plate type	Select the plate type from the list. You can select Nanoplate 26K 8-well, Nanoplate 26K 24-well, Nanoplate 8.5K 24-well, or Nanoplate 8.5K 96-well.
Description	Enter a descriptive information about your experiment.
Labels	Add labels to your plate to help you categorize your experiments.
Plate ownership	Enter users that should be allowed to view and edit the plate according to their permissions. More than one user can be a Plate owner.
Barcode	Enter the barcode that is located on the side of the plate. Barcodes are unique to each plate and can only be used once.

6.5.1 Defining the dPCR parameters

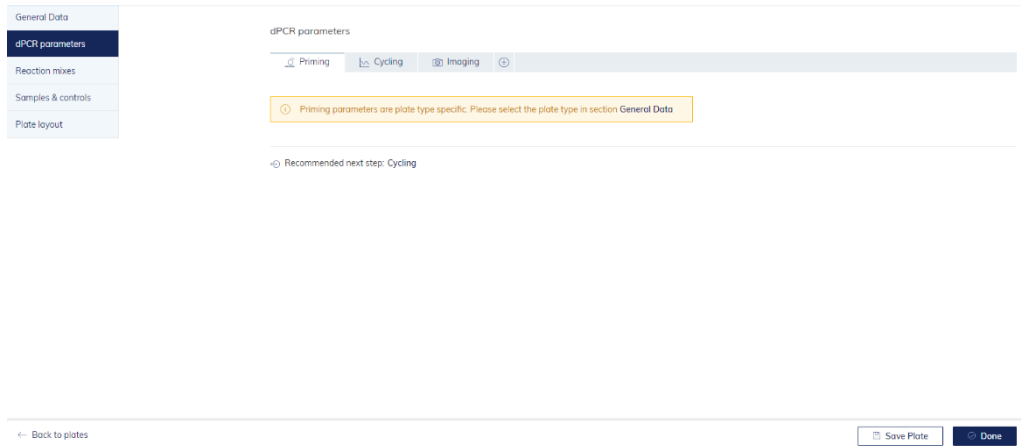

You can set up the run profile of your experiment in the dPCR parameters tab. This tab is divided into three subtabs: Priming, Cycling, and Imaging.

Priming tab

The **Priming** tab enables you to select the priming profile applicable for the plate and your type of experiment.

Cycling tab

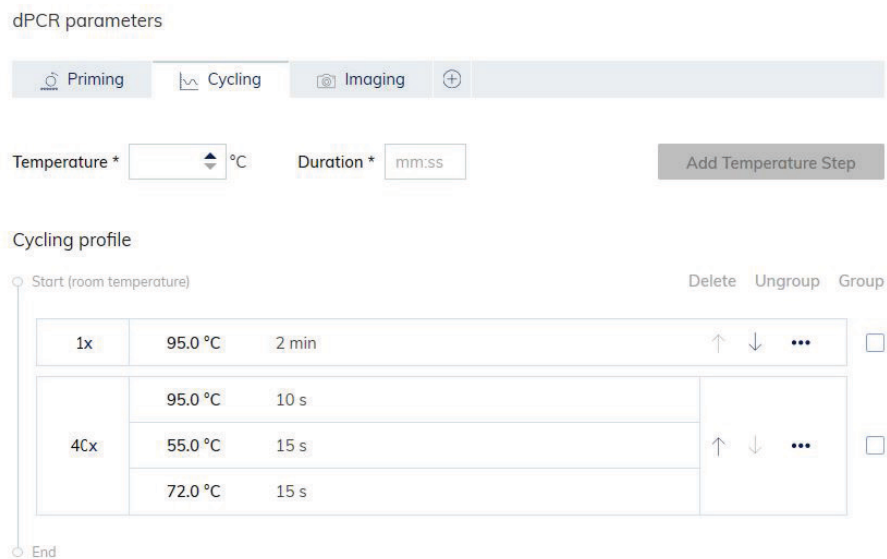

You can define the temperature profile of your experiment in the **Cycling** tab. To do this, follow these steps:

1. In the **Temperature** field, specify the temperature of the step, then specify the duration of the temperature step in the **Duration** field.
2. Click **Add Temperature Step**.
3. The temperature step is added to your cycling profile.
4. Repeat steps 1–2 for all temperature steps.

Note: Use the up and down arrows to arrange the order of the temperature steps.

5. Check the box corresponding to the temperature steps that you want to use for the repeated cycling. Then, click **Group**.
6. In the first column of the grouped temperature steps, add the number of cycles.

Note: To separate the grouped temperature steps, check the box corresponding to the group, then click **Ungroup**. To delete a temperature step, check the box corresponding to the step, then click **Delete**. The three-dotted icon in each temperature step enables you to edit or delete the step.

Important: You can enter values for the temperature between 40°C and 99°C.

Imaging tab

Channel	Exposure duration	Gain
<input checked="" type="checkbox"/> Green	700 ms	8
<input checked="" type="checkbox"/> Yellow	700 ms	8
Channels available for 5-plex instruments only:		
<input checked="" type="checkbox"/> Orange	600 ms	6
<input checked="" type="checkbox"/> Red	400 ms	4
<input checked="" type="checkbox"/> Crimson	500 ms	8

The **Imaging** tab enables you to set the respective exposure duration and gain value for each channel. The channel options depend on the connected instrument. QIAGEN offers QIAcuity One in 2-plex and 5-plex version. QIAcuity Four and QIAcuity Eight offer 5-plex analysis. The following table shows the available channels provided in each instrument.

Note: The instruments offer an exposure duration from 1–4000 ms and a gain value of 0 dB–40 dB.

Table 14. QIAcuity instruments and their available channels

Instrument	Available channels
QIAcuity One, 2-plex	Green Yellow
QIAcuity One, 5-plex	Green Yellow Orange Red Crimson
QIAcuity Four	Green Yellow Orange Red Crimson
QIAcuity Eight	Green Yellow Orange Red Crimson

The following actions can be performed when your run is finished:

- To reimage the plate with different settings, click **+**, then select **Imaging**.
- To rerun the plate with additional cycles, click **+**, then select **Cycling + Imaging**

Important: After a run is finished, remove the plate from the instrument before adding a new imaging or cycling + imaging step.



Note: For QIAcuity Software Suite v2.0 or higher dust detected in one channel is used for finding dust in other channels as well. If required, to improve dust detection always image all channels even not used by assay(s).

6.5.2 Defining reaction mixes

You can create a new reaction mix or use an existing reaction mix for your experiment.

The **General View** tab displays the name of all reaction mixes stored in your database. Click the three-dotted icon of the reaction mix if you want to edit or delete the reaction mix.

Important: Modifying an existing reaction mix changes the settings of the reaction mix in all experiments where it is used.

The screenshot shows the 'Reaction mixes' configuration page in 'General View'. On the left is a navigation menu with 'Reaction mixes' selected. The main area has tabs for 'General View' and 'Detailed List'. A 'New Reaction Mix' button is visible. Below it is a card for 'Reaction Mix 1' with a blue circle icon and a three-dot menu. At the bottom, there is a 'Recommended next step: Samples & controls' message and a footer with 'Back to plates', 'Save Plate', and 'Done' buttons.

The **Detailed List** view tab displays the detailed information about the reaction mixes stored in your database.

The screenshot shows the 'Reaction mixes' configuration page in 'Detailed List' view. The navigation menu and 'New Reaction Mix' button are the same. The 'Detailed List' tab is active, displaying a table with the following data:

Reaction Mix Name	Target Color	Target Name	Dye	Channel	IC
Reaction Mix 1		Target 1		Green	-
		Target 2		Yellow	-

Below the table is a 'Recommended next step: Samples & controls' message and a footer with 'Back to plates', 'Save Plate', and 'Done' buttons.











To create a new reaction mix:

1. Click **New Reaction Mix**.
2. The New Reaction Mix window appears.

New Reaction Mix

 [Edit reaction mix color](#)

Characters left: 100

Color	Target Name *	Dye	Channel *		
	<input type="text"/>	Select ▼	Select ▼	<input type="checkbox"/> Internal control	
	<input type="text"/>	Select ▼	Select ▼	<input type="checkbox"/> Internal control	
	<input type="text"/>	Select ▼	Select ▼	<input type="checkbox"/> Internal control	
	<input type="text"/>	Select ▼	Select ▼	<input type="checkbox"/> Internal control	
	<input type="text"/>	Select ▼	Select ▼	<input type="checkbox"/> Internal control	

3. Enter the name of the reaction mix in the **Reaction mix name** field. The name must be unique and must not contain any special characters. You can enter up to 100 characters in this field.
4. Click **Edit reaction mix color** to select a color for the reaction mix.
5. Enter a target name in the **Target Name** field. The name must be unique and must not contain any special characters. You can enter up to 100 characters in this field.
Note: The **Color** box shows the color of the single target in the reaction mix.
6. Select the channel from the channel list where your target is detected.
7. Optional: Select the dye of the target from the **dye** list. Selecting a dye automatically sets the associated channel in the **Channel** list.
8. If the target is an internal control, check the **Internal control** box.
Note: Clicking the trash icon deletes all entries in the corresponding row.
9. Click **Create**.
10. The reaction mix is added to your database and can be used for your experiment.

6.5.3 Defining samples and controls

Adding new samples

To add a new sample:

1. In the Samples tab, click **New Samples**.
2. The New Samples window appears.

Sample ID 01

Sample name * Characters left: 80

Labels Labels left: 10
Confirm each label with 'Enter' button

Amount *
1

Description Characters left: 1000

Cancel Create

3. Enter the following information in the required fields:

- **Sample Name:** Enter the sample name. The name must be unique and must not contain any special characters. You can enter up to 100 characters in this field.
Note: The Sample ID is automatically generated. This ID is unique for each sample created.
- **Labels:** You can add labels to your samples to help you categorize your experiment.
- **Amount:** Enter the number of samples that shall have the same sample name. They will automatically be numbered behind the sample name with 01, 02, 03 etc.
- **Description:** Specify a description for your sample.

4. Click **Create**.

5. The sample(s) is/are added to your database and can be used for your experiments.

The screenshot shows the 'Samples & controls' section of a software interface. On the left is a navigation menu with options: General Data, dPCR parameters, Reaction mixes, Samples & controls (highlighted), and Plate layout. The main area is titled 'Samples & controls' and has three tabs: Samples, Controls, and Non Template Controls. The 'Samples' tab is active, showing a '+ New Samples' button and a table with three rows: 01 Sample 1, 02 Sample 2, and 03 Sample 3. Each row has a three-dot menu icon on the right. Below the table is a recommendation: 'Recommended next step: Samples & controls - Controls'. At the bottom, there are three buttons: 'Back to plates', 'Save Plate', and 'Done'.

Adding controls and non-template controls

You can add positive or negative controls to your experiments.

To add controls:

1. Click the **Controls** tab.
2. Enter the name of your control in the **Control Name** field.
3. Click **Add Control**.
4. The control is added to your database and can be used for your experiment.

The screenshot shows the 'Samples & controls' section with the 'Controls' tab selected. The 'Control Name *' field contains 'Mutant Control' and has a character count of 86. An 'Add Control' button is next to the field. Below the field is a list of existing controls, showing 'Wildtype Control' with a three-dot menu icon. A recommendation at the bottom says 'Recommended next step: Samples & controls - Non Template Controls'. The bottom navigation bar includes 'Back to plates', 'Save Plate', and 'Done' buttons.

To add Non Template Controls:

1. Click the **Non Template Controls** tab.
2. Specify the name of your non template control in the **Non Template Control Name** field.
3. Click **Add NTC**.
4. The non template control is added to your database and can be used for your experiment.

- General Data
- dPCR parameters
- Reaction mixes
- Samples & controls**
- Plate layout

Samples & controls

Samples Controls **Non Template Controls**

Non Template Control Name * Characters left: 95

NTC 2

NTC 1 ...

↻ Recommended next step: Plate layout

[← Back to plates](#)

6.5.4 Defining plate layouts

To define the plate layout, you must add reaction mix, samples, and controls to your plate.

Adding a reaction mix to the plate

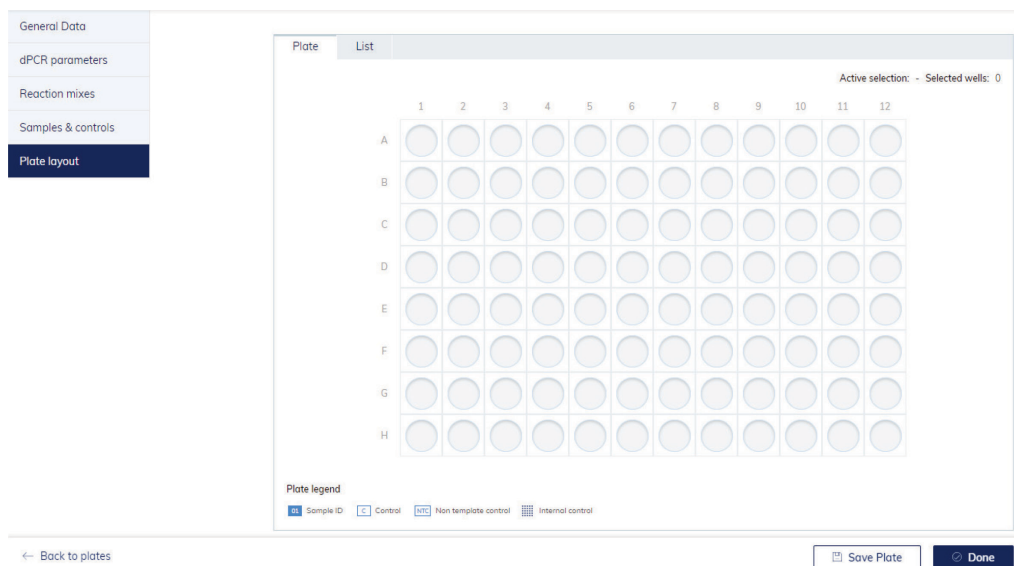

1. Left-click the well you want to mark.
2. Left-click the + icon, then select **Add reaction mix** or **Mark as blank**. The Add reaction mix window appears.

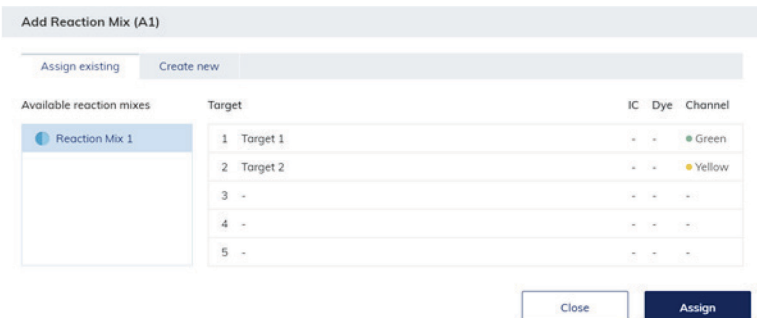

3. Select the reaction mix you want to add to the plate. To create a new reaction mix, click the **Create new** tab. See Defining reaction mixes for information about creating a new reaction mix.

4. Click **Assign** to add the reaction mix to the well.

Note: To edit or remove the reaction mix from the well, right-click the well and select **Edit reaction mix** or **Remove reaction mix**. You can also remove the reaction mix from the well by clicking the  icon and select **Remove reaction mix**.

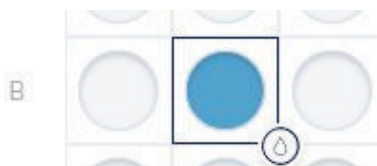

Adding samples to the plate

1. On a marked well, click the  icon or right-click the well.

Note: You can also mark more than one well if you want to assign a sample to multiple wells.

2. Click **Add sample**.

3. The Add Sample window appears.

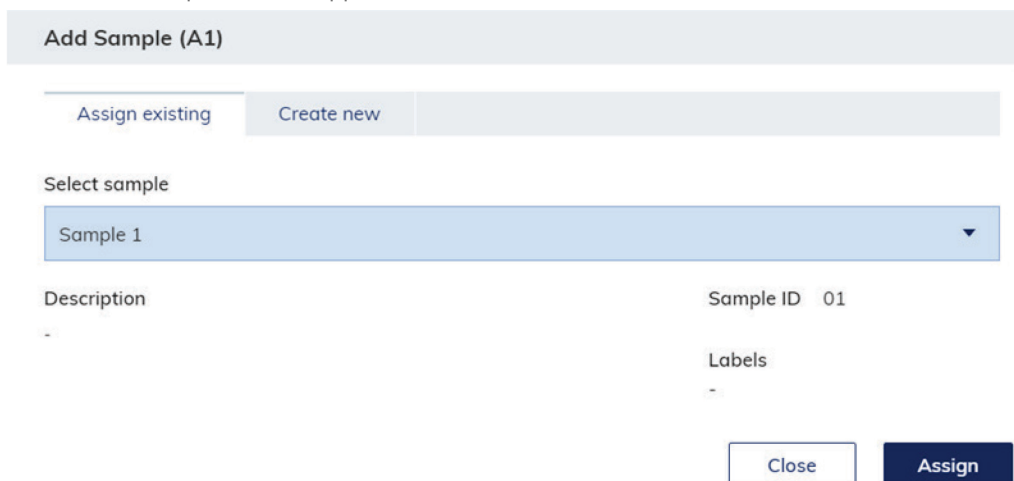

The screenshot shows the 'Add Sample (A1)' dialog box. It has two tabs: 'Assign existing' and 'Create new'. Below the tabs is a 'Select sample' dropdown menu with 'Sample 1' selected. Underneath, there are fields for 'Description' (containing a hyphen) and 'Sample ID' (containing '01'). There is also a 'Labels' field with a hyphen. At the bottom right, there are two buttons: 'Close' and 'Assign'.

4. Select a sample to add to the plate. To create a new sample, click the **Create new** tab. See Defining Samples & Controls for information about creating new samples.

5. Click **Assign**.

6. The sample is added, and the well is marked with the Sample ID.

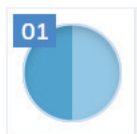

Note: To edit the sample or remove it from the well, right-click the well and click **Edit sample** or **Remove sample**. To remove the sample and the reaction mix from the well, select **Clear well**.

Adding controls to the plate

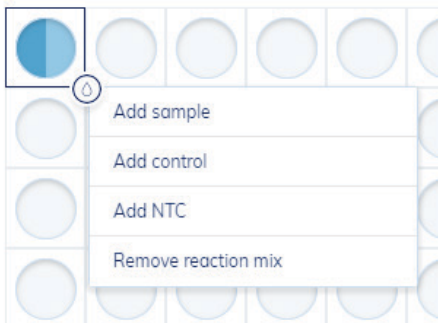

1. On a marked well, click the  icon or right-click the well.

Note: You can also mark more than one well if you want to assign a control to multiple wells.

2. Click **Add control**.

3. The Add Control window appears.

Add Control (A2)

Control name *
 ✕ ▼

Selected reaction mix	Target	Control type *	Dye	Channel
<div style="display: flex; align-items: center;"> <div style="width: 15px; height: 15px; background-color: #0070c0; border-radius: 50%; margin-right: 5px;"></div> Reaction Mix 1 </div>	1 Target 1	Positive ▼	-	Green
	2 Target 2	Negative ▼	-	Yellow
	3 -	-	-	-
	4 -	-	-	-
	5 -	-	-	-

Close
Assign

4. Select the control you want to add to the plate from the Controls list or enter a new control name.

5. In the **Control type** list, select whether the control is positive or negative for the specific target.

6. Click **Assign**.

7. The control is added and the well is marked with a **C**.

Note: To edit or remove the control from the well, right-click the well and select **Edit control** or **Remove control**. You can also remove the control from the well by clicking the  icon and select **Remove control**. To remove the control and the reaction mix from the well, select **Clear well**.

Adding NTCs to the plate

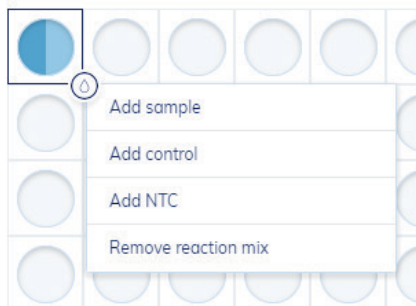

1. On a marked well, left-click the  icon or right-click the well.
Note: You can also mark more than one well if you want to assign a Non Template Control to multiple wells.
2. Click **Add NTC**.
3. The Add Non Template Control window appears.

Add Non Template Control (A3)

Non Template Control name *

Close Assign

4. Select an existing NTC from the **Non Template Control name** list or enter a new Non Template Control name.
5. Click **Assign**.
6. The NTC is added and the well is marked with **NTC**.

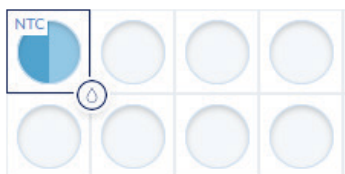

Note: To edit or remove the NTC from the well, right-click the well and select **Edit NTC** or **Remove NTC**. You can also remove the control from the well by clicking the  icon and select **Remove NTC**. To remove the NTC and the reaction mix from the well, select **Clear well**.

6.5.5 List view

The list view in the Plate Layout tab displays a detailed overview about your plate setup.

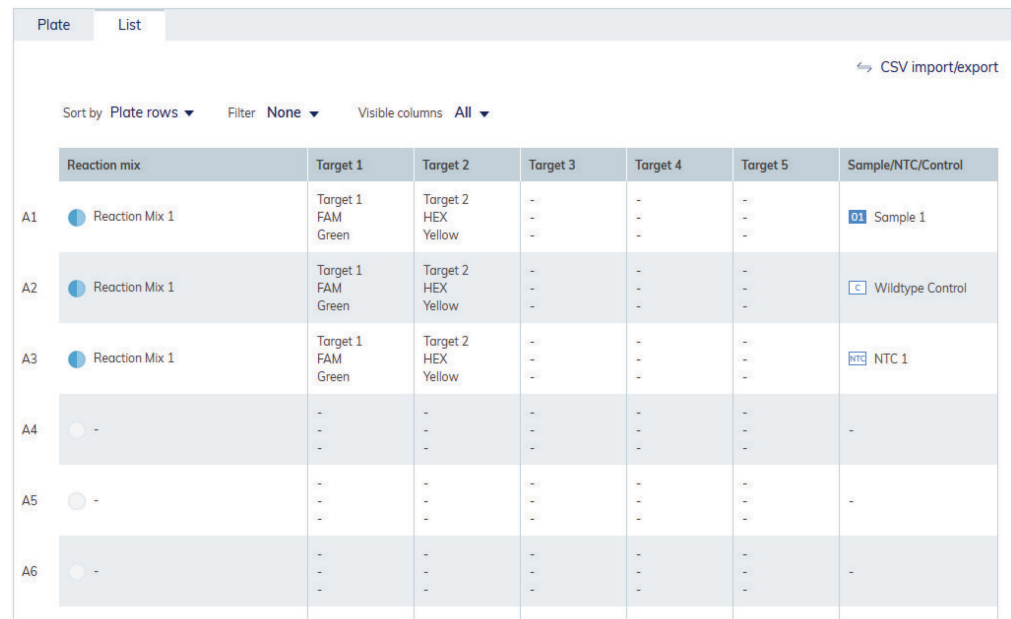

The screenshot shows the 'List' view of a plate layout. At the top, there are tabs for 'Plate' and 'List', with 'List' selected. A 'CSV import/export' link is visible in the top right. Below the tabs, there are controls for 'Sort by Plate rows', 'Filter None', and 'Visible columns All'. The main table has the following structure:

	Reaction mix	Target 1	Target 2	Target 3	Target 4	Target 5	Sample/NTC/Control
A1	Reaction Mix 1	Target 1 FAM Green	Target 2 HEX Yellow	-	-	-	01 Sample 1
A2	Reaction Mix 1	Target 1 FAM Green	Target 2 HEX Yellow	-	-	-	Wildtype Control
A3	Reaction Mix 1	Target 1 FAM Green	Target 2 HEX Yellow	-	-	-	NTC NTC 1
A4	-	-	-	-	-	-	-
A5	-	-	-	-	-	-	-
A6	-	-	-	-	-	-	-

You can modify this view by sorting and filtering:

- Sort by rows or columns
- Filter by existing reaction mixes
- Hide specific columns

6.5.6 CSV import/export

You can export the list view as CSV file. Click **CSV import/export**, then click **Export to CSV** to export the list view as a CSV file.

You can also import sample names and reaction mix from a CSV file to define the plate layout. First, make sure that the Plate was saved and shows Plate status Defined before importing a CSV template file. Click **CSV import/export** then click **Import from CSV**. A new window appears where you can upload the CSV file.

The data need to be entered and saved in the right format; therefore a CSV template is provided for download which helps you to enter your data in the correct format. Click **CSV import/export**, and then click **Download CSV template**.

Note: CSV import requires a comma-separated CSV file. Check the regional settings of your system for the decimal separator. Please insert samples names in column Sample and reaction mix names in column Reagents without using special characters. If there is a pre-defined reaction mix in the plate experiment, please make sure to use the identical the reaction mix name in the CSV file.

The CSV file import has two options:

- The Overwrite existing data option can be used to overwrite the existing plate layout with the plate layout stated in the CSV file.
- The Create Reaction Mixes, Samples, if not defined in the Plate option needs to be selected, if not existing samples and reaction mixes should be created automatically due to CSV import. This option needs to be chosen if the CSV file includes reaction mix and sample names that have not been pre-defined in the plate experiment.
- Both the options Overwrite existing data and Create Reaction Mixes, Samples, if not defined in the Plate, can be selected in the same time.

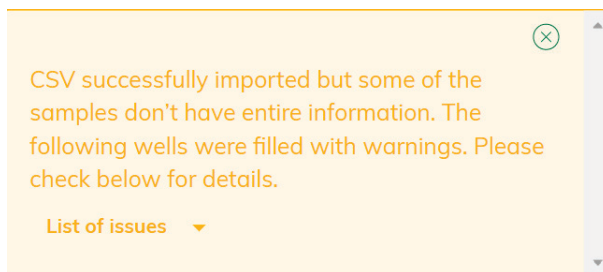

Example case 1: No reaction mix and samples were defined in plate experiment. Select Create Reaction Mixes, Samples, if not defined in the Plate option for CSV Import. Make sure that sample(s) and reaction mix(s) are defined in CSV file. After import, the reaction mix and samples will be created and the Plate layout will be filled according to the CSV file. A reaction mix with default target name and default channel will be defined and the following warning message will appear. This warning message can be ignored.













Please click on section Reaction mixes, select reaction mix, and define the correct target name(s) and channel(s) after import of CSV file.

Edit Reaction Mix

 This modification is going to change this reaction mix everywhere it's used. If you'd like to assign another reaction mix, remove this one from the well first.

  Edit reaction mix color

Reaction mix name * Characters left: 97

Color	Target Name *	Dye	Channel *		
	<input type="text" value="DUMMY"/>	<input type="text" value="Select"/>	<input type="text" value="Green"/>	<input type="checkbox"/> Internal control	
	<input type="text"/>	<input type="text" value="Select"/>	<input type="text" value="Select"/>	<input type="checkbox"/> Internal control	
	<input type="text"/>	<input type="text" value="Select"/>	<input type="text" value="Select"/>	<input type="checkbox"/> Internal control	
	<input type="text"/>	<input type="text" value="Select"/>	<input type="text" value="Select"/>	<input type="checkbox"/> Internal control	
	<input type="text"/>	<input type="text" value="Select"/>	<input type="text" value="Select"/>	<input type="checkbox"/> Internal control	

Now, choose **Update** and **Save changes** to save.

Example case 2: The Plate definition in the Suite includes a reaction mix and some samples or controls; also, the Plate layout is partly defined. Existing parts shall not be overwritten. By using the CSV import function, residual empty wells should be filled with the same reaction mix and additional sample(s) that have not been created in section Samples & controls. For this CSV file, make sure that the positions of pre-defined wells are empty and only the residual wells are defined that should be filled. Select Create Reaction Mixes, Samples, if not defined in the Plate option for CSV Import. After import, additional samples will be created and the Plate layout of empty wells only will be filled according to the CSV file. Pre-defined filled wells will not be overwritten.

Example case 3: The plate layout is already defined in Suite and should be overwritten with new reaction mix and sample(s) that have not been created in sections Reaction mix and Samples & controls. Choose both options, Overwrite existing data, and Create Reaction Mixes, Samples, if not defined in the Plate for CSV import. The Plate layout will be overwritten according to the CSV file. Reaction mix and samples stated in CSV file will be created. The created reaction mix has a default target name and default channel. Please click on section Reaction mixes, select reaction mix, and define the correct target name(s) and channel(s) after import of CSV file.

Example case 4: The Plate definition in Suite includes the correct reaction mix and samples, and the Plate layout should be overwritten. The CSV file includes identical sample and reaction mix names in different order. In this case, only the option Overwrite existing data needs to be chosen for CSV import. The Plate layout will be overwritten according to the CSV file.

Note: For CSV import, the dPCR parameters need to be defined for the Plate.

When will the CSV import function fail?

If the Plate layout is partly filled and a fully filled CSV file should be imported without selecting the Overwrite existing data option. If this option is not selected, the application will fail to import in case there are any existing data, e.g., like reaction mixes in wells that are being imported.

If no reaction mix and samples were defined in plate experiment and CSV file with new reaction mix and samples should be imported without selecting the option Create Reaction Mixes, Samples, if not defined in the Plate.

6.5.7 Managing your plates

To enter the Plates environment, click **Plates** in the Main toolbar. Existing plates are shown in the Plates Overview window.

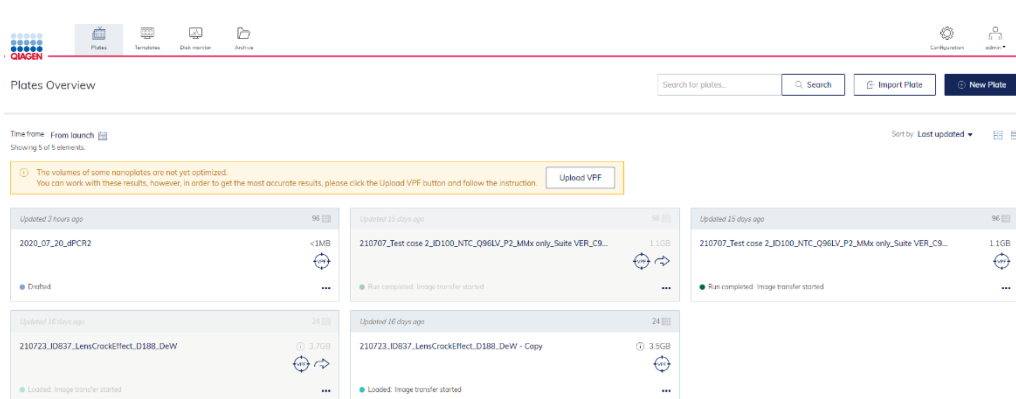

Sorting

You can sort the Plates Overview window by Last updated, Plate name, or Plate status.

1. Click the symbol for tile or list view to switch views within the Plates Overview window.

Note: Both views provide information regarding the plate name, plate status, modified date, type of plate, and used disk space.

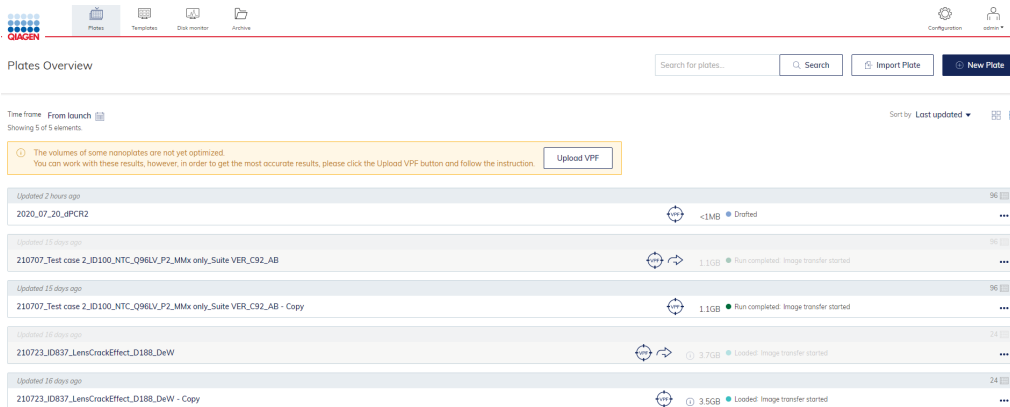

2. On a specific plate, click the three-dotted button. The context menu provides an option to edit, delete or analyze the plate. It also points you to the existing reports and enables you to export the plate. When the selected plate is currently running, you can see the run status and the respective plate details.

Search

The plates overview screen provides a search for plates functionality with plate name or barcode as search criteria. For this type a letter combination as search string in the input field left from the search button and click . The plates overview page is filtered and only plates with the given letter combination in its plate name are shown in the overview page. The search functionality is not case sensitive.

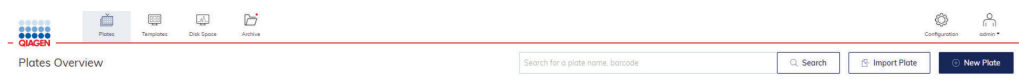

Note: If the plate is bigger than 2.5 GB, a tooltip next to plate size will be shown, stating that it may not be archived and exported.



To get back from the search view to the general plates overview, either empty the search field and click or press **Esc** on your keyboard while the text field is active.

Filtering

Click the calendar symbol beside Time Frame to limit the overview results to plates modified within a specific period. A window appears to enable you to select or enter a specific time frame depending on the results you want to see in the overview. Click **Apply** to filter the results.

The screenshot shows a filtering interface with a calendar for March 2020. On the left, there are four buttons: 'From launch', 'Last 7 days', 'This month', and 'Last year'. Below these are 'From' and 'To' date input fields. The 'From' field contains '03/03/2020' and the 'To' field contains '03/21/2020'. A dark blue 'Apply' button is positioned below the date fields. To the right of the date fields is a calendar grid for March 2020. The grid has columns for days of the week (M, T, W, T, F, S, S) and rows for weeks. The dates from the 3rd to the 21st are highlighted in a light blue color. The 'Apply' button is located at the bottom center of the interface.

Export and Import plate data

To archive your data and free-up disk space, you can export a plate as password protected zip file. Click the respective plate in the plates overview. On the left side of the screen, click **Export plate**. The plate is exported as a password protected zip file.

Note: Due to technical restrictions, there is no possibility to export plates bigger than 2.5 GB.

After exporting and saving the password protected zip file, you can delete the plate by clicking **Delete** on the left side of the screen. For more information about disk space, see Maintenance Procedures.

The screenshot shows a form for editing plate details. On the left is a sidebar with navigation icons and labels: 'Analyze', 'Reports', 'Export', 'Archive', 'Support package', and 'Delete'. The main form has three sections: 'Plate name *' with a text input field containing '210707_Test case 2_ID100_NTC_Q96LV_P2_MMx only_Suite VER_C92_AB - Copy' and 'Characters left: 30'; 'Plate type' with a dropdown menu showing 'Nanoplate 8.5K 96-well'; and 'Description' with a text area containing 'NTC: Q96LV: Fm002(Good Plates) Molding Lot: 002' and 'Characters left: 1644'.

If you want to import a plate again, click **Import Plate** in the plates overview.



A new window appears where you can import plate data by uploading the password protected zip file. Click **Import** and the plate is added to the plates overview.

Note: An already existing plate cannot be imported again.

Note: Due to technical restrictions, there is no possibility to import plates bigger than 2.5 GB.

Note: If a plate from previous version is imported to newer Suite version, then it will be visible in read-only mode and needs to be upgraded to be edited. There is no possibility to import the plate from lesser Suite versions than 1.2.18. Exported plates from version 1.1.3 cannot be imported to version 2.0 or 2.1. Therefore, import them into 1.2.18 prior the update if data are required for further analysis.

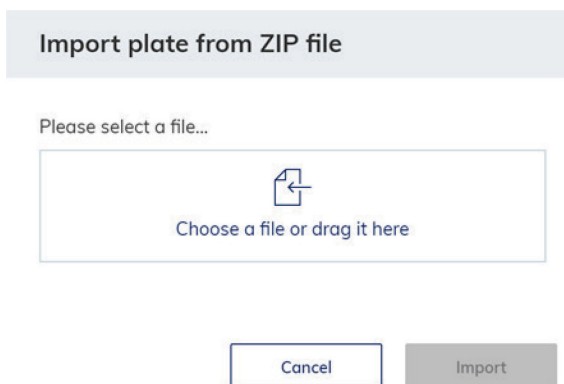

6.6 Setting up templates

You can create templates to set up your experiments. You can create a new template or use an existing plate and save it as template.

Note: Template creation is permission dependent.

6.6.1 Creating a new template

1. In the Main Toolbar, click **Templates**, then click **New template**.

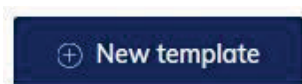

2. The Create New Template window appears.

3. Enter the name for the template in the **Template name** field. You can enter up to 100 characters in this field. Click **Next**.

Follow the steps as described in the section Setting up an experiment.

1. After you have entered all required information, click **Save Template**.

2. The template is stored in the database and can be used for future experiments.



6.6.2 Saving a plate as template

Follow the steps to set up a new plate as described in section Setting up an experiment. After you have entered all required information, you can save the information as a template to use for future plates.

1. Click **Plate templates** in the upper right corner of the screen.

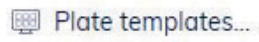

2. Click **Save as template**.

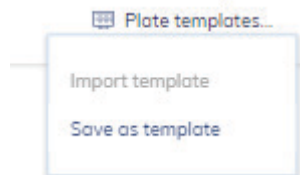

3. The Save as Plate Template window appears.

4. Enter the name of the template in the **Template name** field.

Note: Click **Already existing Plate Templates** to display an overview of the existing plate templates.



The dialog box is titled "Save as Plate Template". It contains a text input field labeled "Template name *". Below it is a section titled "Already existing Plate Templates" with a downward arrow, containing a list item "First Template" with a small grid icon to its left. At the bottom are "Cancel" and "Save" buttons.

6.6.3 Using a template to create a new plate

1. In the Main toolbar, click **Plates**, then click on **New Plate**.



2. Click Plate templates, then click **Import template**.

3. The Import Plate Template window appears with all existing templates.

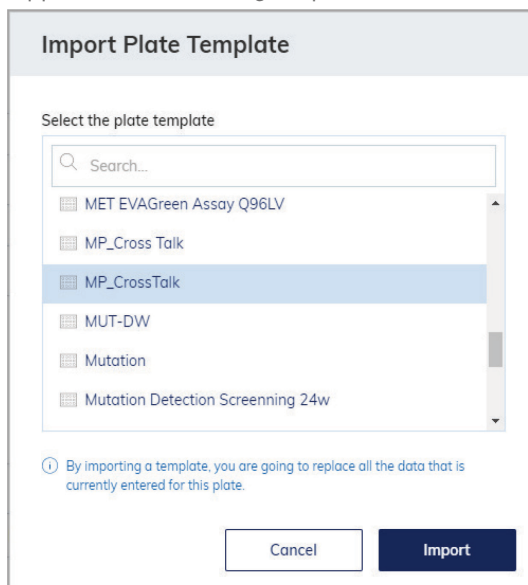

The dialog box is titled "Import Plate Template". It features a search bar labeled "Select the plate template" with a magnifying glass icon and the text "Search...". Below the search bar is a list of templates, each with a small grid icon: "MET EVAGreen Assay Q96LV", "MP_Cross Talk", "MP_CrossTalk" (highlighted in blue), "MUT-DW", "Mutation", and "Mutation Detection Screening 24w". At the bottom, there is a warning icon (i) and text: "By importing a template, you are going to replace all the data that is currently entered for this plate." Below this are "Cancel" and "Import" buttons.

4. Select an existing template, then click **Import**.

5. All information in the selected template is automatically transferred to the new plate setup.

Managing your templates

To enter the Templates environment, click **Templates** from the Main toolbar. The overview screen lists all existing templates.

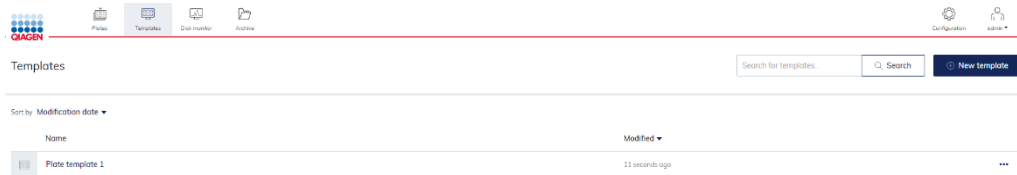

On a specific template, click the three-dotted button to open a context menu that provides an option to **edit**, **delete** or **use the template in a new plate**.

Sorting

You can sort the Templates Overview window by modification date or name. Sorting the templates by the modification date enables you to view the recently modified entries.

Filtering

You can search for specific templates by entering the name in the **Search** field.

New template

See section Setting up templates how to create a new template.

6.7 Analysis

The QIAcuity Software Suite enables you to analyze plates that have been processed by the instrument. The following analysis options are available in the software:

- Absolute Quantification
- Mutation Detection
- Genome Editing
- Copy Number Variation
- Gene Expression



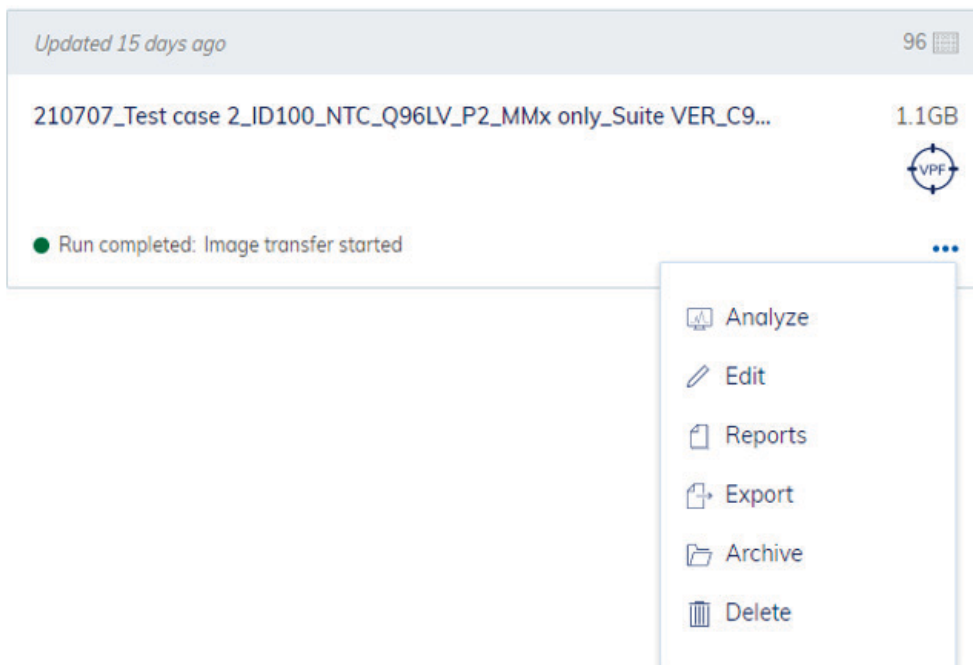

6.7.1 Accessing the analysis environment

To access the Plate Analysis environment:

1. On the Plates Overview page of the Plates environment, search for the plate that you want to analyze. Alternatively, you can open the Plate Analysis environment. Click the plate name in the Plates overview, then select **Analyze** from the context menu.
2. **Note:** The plate run must be completed.
3. Click the More  icon.



The screenshot displays a table of plate analysis results. The top row is highlighted in light gray and contains the text "Updated 15 days ago" on the left and "96" with a grid icon on the right. Below this, a row represents a specific plate with the name "210707_Test case 2_ID100_NTC_Q96LV_P2_MMx only_Suite VER_C9..." and a size of "1.1GB". To the right of the plate name is a circular icon with "VPP" and arrows. Below the plate name, a green dot indicates "Run completed: Image transfer started". A context menu is open over the "More" icon (three dots) on the right side of the plate row, listing the following actions: Analyze, Edit, Reports, Export, Archive, and Delete.

Updated 15 days ago		96 
210707_Test case 2_ID100_NTC_Q96LV_P2_MMx only_Suite VER_C9...	1.1GB	
 Run completed: Image transfer started		

- Analyze
- Edit
- Reports
- Export
- Archive
- Delete

4. Select **Analyze** from the context menu.

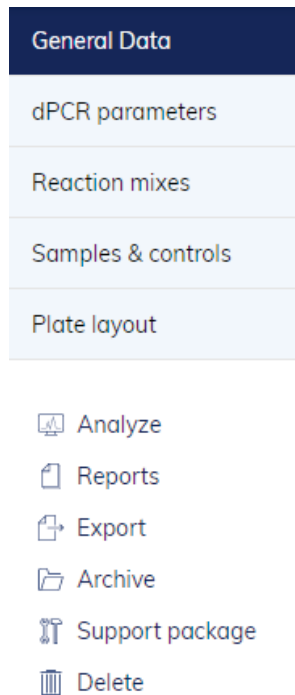

6.7.2 Images

- The Software Suite also enables you to view the images. After a run is completed, you can view the images in the Plate Analysis environment. For more information about how to access the Plate Analysis, see section Accessing the analysis environment. To access the images, click **Check source images**.
- To select a channel, click the corresponding button next to the relevant channel. Only channels where imaging took place are available.
- To zoom in and out, click the image.
- To download, click the image to open it on a new window. Then, click the  icon located at the top left corner of the image.

Select imaging step



Select channel

Green Yellow Orange Red Crimson Reference channel

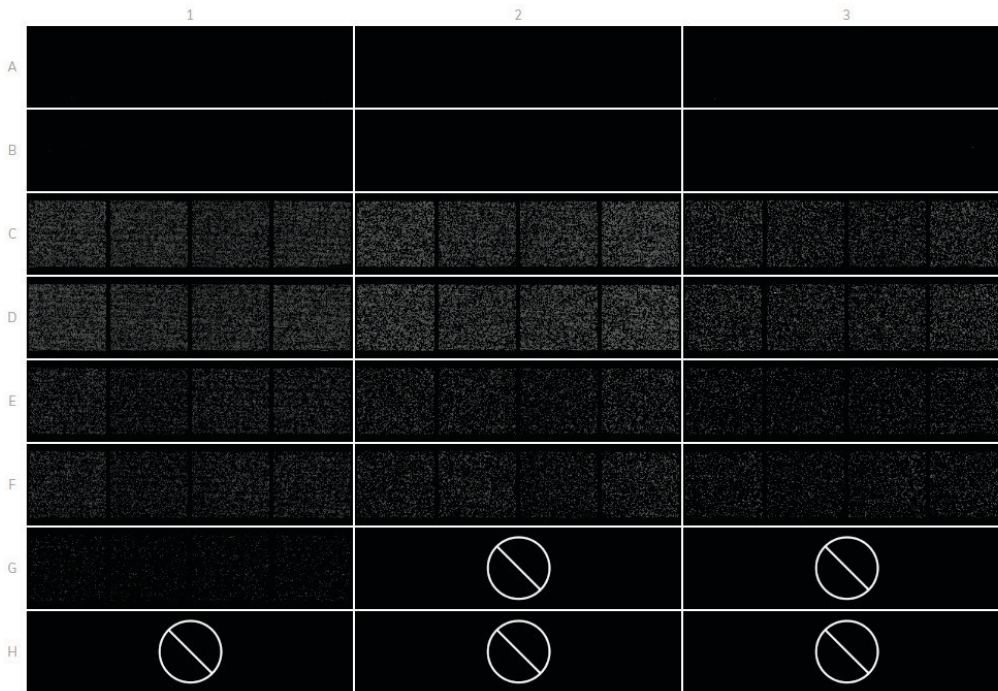



Note: Errors affecting single wells or empty wells are indicated by a  symbol in the affected well. Try reimaging the plate with different exposure and/or gain settings. If the error persists, create a support package and contact QIAGEN Technical Services.

Image quality control

The fluorescence signal in the reference channel is measured to determine the number of valid partitions in a well. Differences in the signal intensities between partitions are normalized and the fluorescence signals in the target channels are corrected accordingly.

If the fluorescence signal is saturated in too many partitions of a well in a target channel, a warning message will be shown to the customer. Furthermore, saturated signals are marked with  in the Results overview.  Saturated signals lower the signal-to-noise ratio and can lead to improper analysis results, e.g., the crosstalk correction algorithm might be affected. The recommendation is to re-image the plate with 30% less exposure time in the respective channel.

Note: The optimal RFU range of your positives is between 80–120 to avoid saturation and proper functioning of image analysis algorithms. Use exposure time changes (linear dependency) to optimize your RFU level. For RFU values below 60, it is recommended to increase the exposure time of the corresponding channel/s, and for RFU values below 150, it is recommended to decrease the exposure time of corresponding channel/s.

① The signal for channels Green reached the saturation. Try re-imaging the plate with reduced exposure time and gain settings to fix this issue.

The image shows a 12x8 grid of wells labeled A through H and 1 through 12. Each well contains a camera icon. Wells A through D are blue, E through H are green. A warning message is shown above the grid: "① The signal for channels Green reached the saturation. Try re-imaging the plate with reduced exposure time and gain settings to fix this issue." To the right of the grid is a control panel with "Analyze per" (Target/Channel), "Select targets" (input field), and "Show results" button.

In case more than one imaging step has been done, the imaging step where the saturation occurred is marked in yellow and the warning message is shown when moving the mouse over the camera icon.

The image shows a close-up of a camera icon with a tooltip. The tooltip text reads: "For this imaging step the signal for channels reached the saturation. Try re-imaging the plate with reduced exposure time and gain settings to fix this issue." Below the icon are two buttons labeled "1" and "2". Below the buttons are labels for "Green (1000ms / 10)" and "Red (800ms / 8)".

6.7.3 Invalidation of images

In rare cases it can happen, that the image quality is too low and the image cannot be used for further analysis. A message is shown to the customer that some wells have been invalidated. Those wells are greyed out in the plate layout and cannot be used for the result analysis.

Note: This message also appears if not all wells were used in the run. For that situation, please ignore the message.

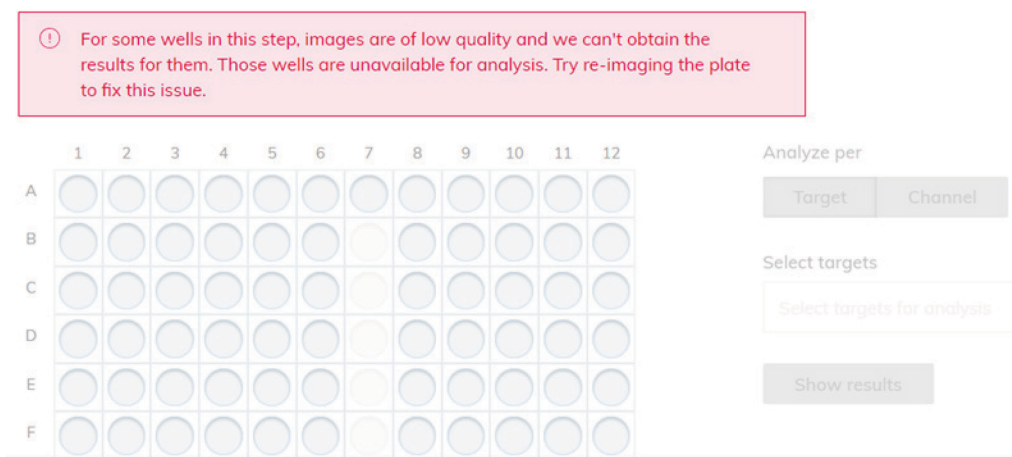

In case more than one imaging step has been done, the imaging step where the low signal quality occurred is marked in red and the message is shown when moving the mouse over the camera icon.

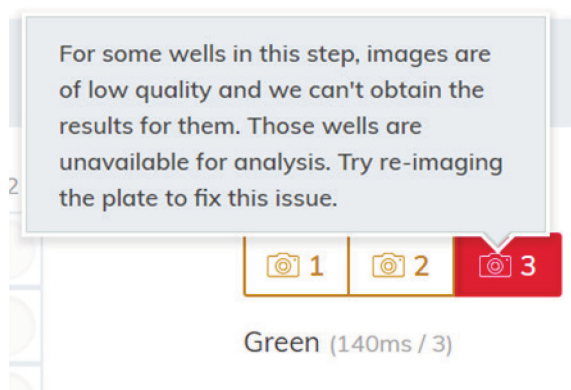

Reasons for the invalidation of an image are:

- Too less fluorescence signal, for example, when the Nanoplate was re-imaged after a long storage period (see Operating Plates for information about the storage of plates).
- Vibration during the imaging process can lead to blurry images. If the image of the reference channel is affected, the number of valid partitions cannot be determined and the whole well is invalidated for analysis. If a target channel is affected, only the image of the respective channel is invalidated for analysis.
- Incomplete filling of a well can lead to too less valid partitions in the reference channel needed for analysis. In this case, the whole well is invalidated.

6.7.4 Image corrective measures

To ensure proper analysis based on valid partitions, artefacts that could influence the result analysis are removed from the images. The corrections are done automatically by the QIAcuity Software Suite and don't require any user action. The partitions that are affected by artefacts are blacked out and are invalidated for further analysis. Artefacts can be:

- Dust and other particles
- Low amplification areas
- Areas of bad filling

6.7.5 Dust and other particles

Dust and other particles like hairs or strands are detected by the QIAcuity Software Suite and are removed from the images. This figure shows an example of a well before and after dust/other particles correction.

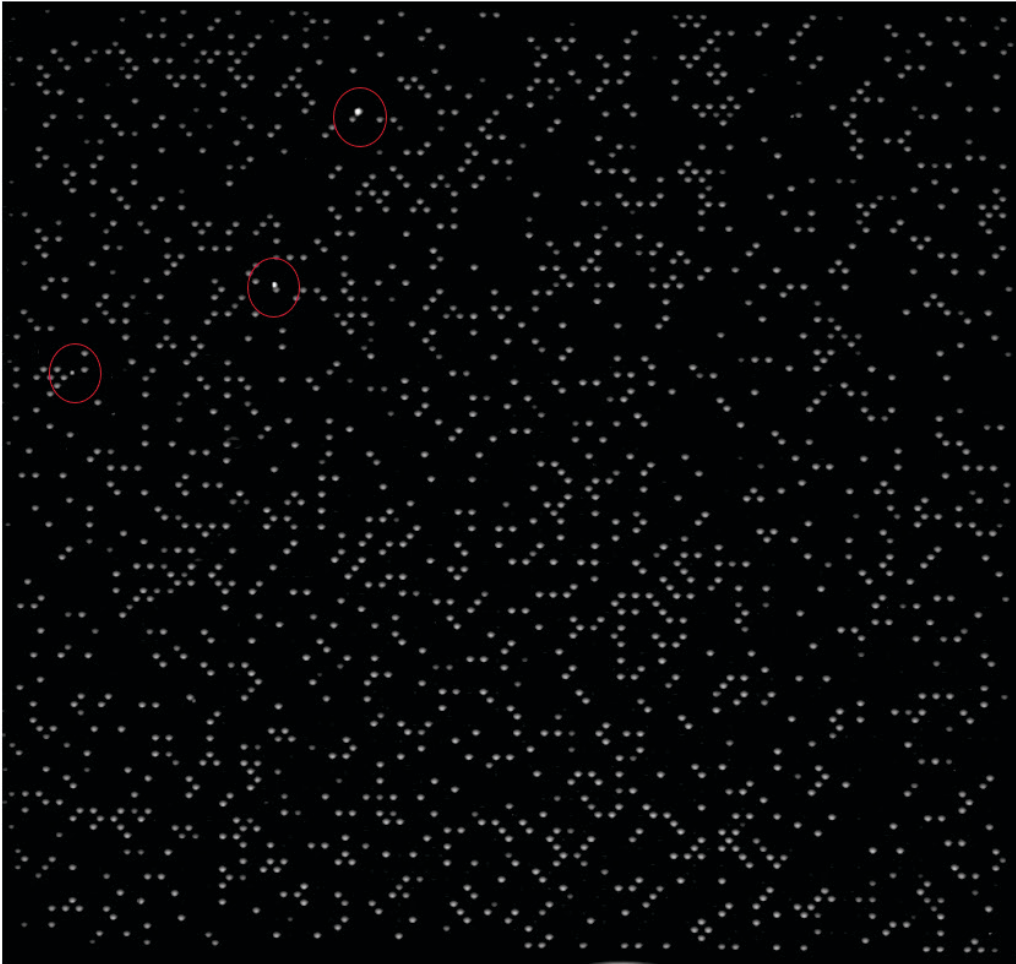

Raw image of a well showing dust particles (marked with red circles)

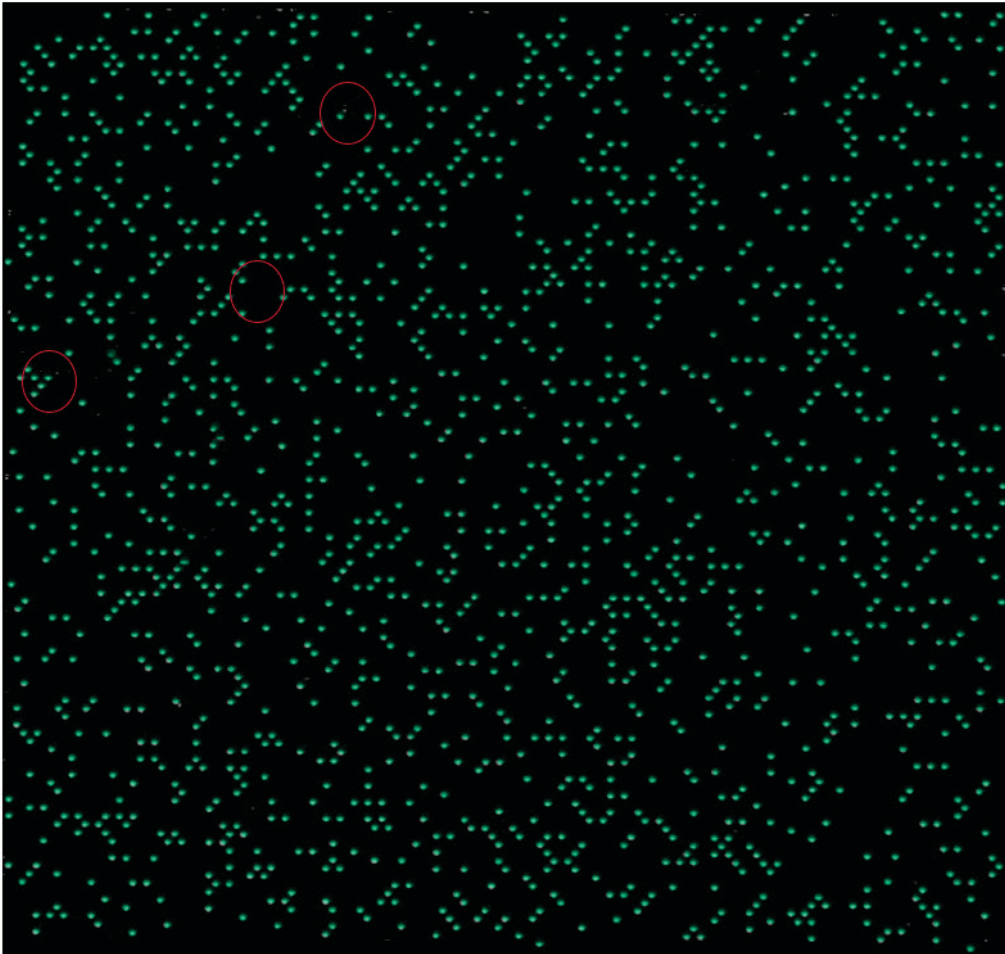

Signal map of the dust-corrected image

In case the images still show dust particles or other particles after the correction, the recommendation is to unload the plate, wipe the plate with a lint-free tissue and to re-image the plate.

Note: For QIAcuity Software Suite v2.0 or higher, dust detected in one channel is used for finding dust in other channels as well. If required, to improve dust detection, always image all channels even not used by assay(s).

The QIAcuity Software Suite version 2.1 exhibits an improvement for dust detection for dust causing light infections of neighbor partitions. This figure shows an example of a well before and after smear dust correction.

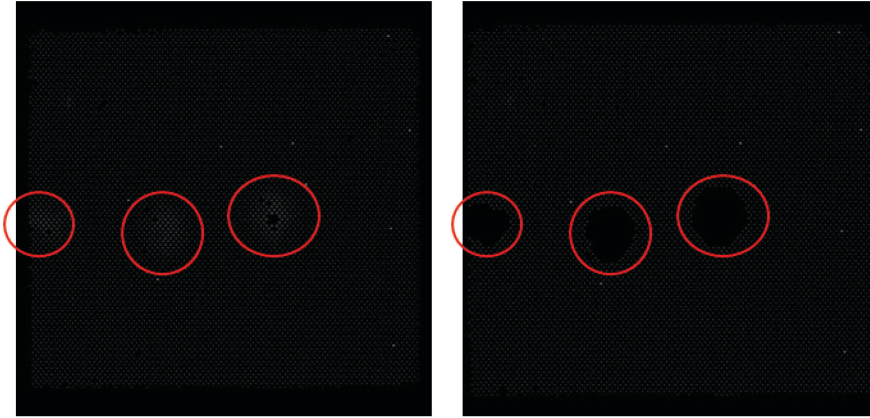

Improved dust detection for dust causing light infections of neighbor partitions: left, not sufficient dust removal; right, sufficient dust removal with QIAcuity Software version 2.1. Affected area is removed from analysis and therefore partitions are invalidated.

6.7.6 Low amplification areas

In case of low amplification areas, the fluorescence signal in the target channels is less pronounced or not detectable in certain areas of the well. The signal in the reference channel is not affected. If an equal amplification did not take place in the well, the area of low amplification does not meet the requirements for Poisson distribution. Therefore, the partitions in those areas are blacked out in the image and are not included in the analysis.

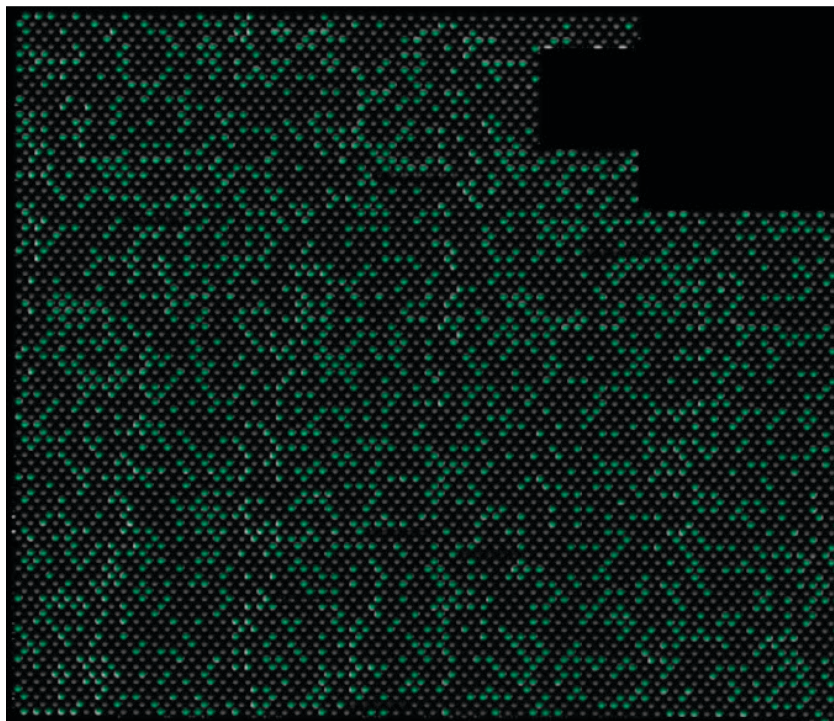

Signal map of an image with blacked-out low amplification areas

6.7.7 Areas of bad filling

Incorrect pipetting or sealing can lead to areas of the well which are not filled with reaction mix. Those areas affect the reference channel as well as the target channels and reduce the number of valid partitions. See Operating Plates for instructions on how to pipet and seal the Nanoplates properly.

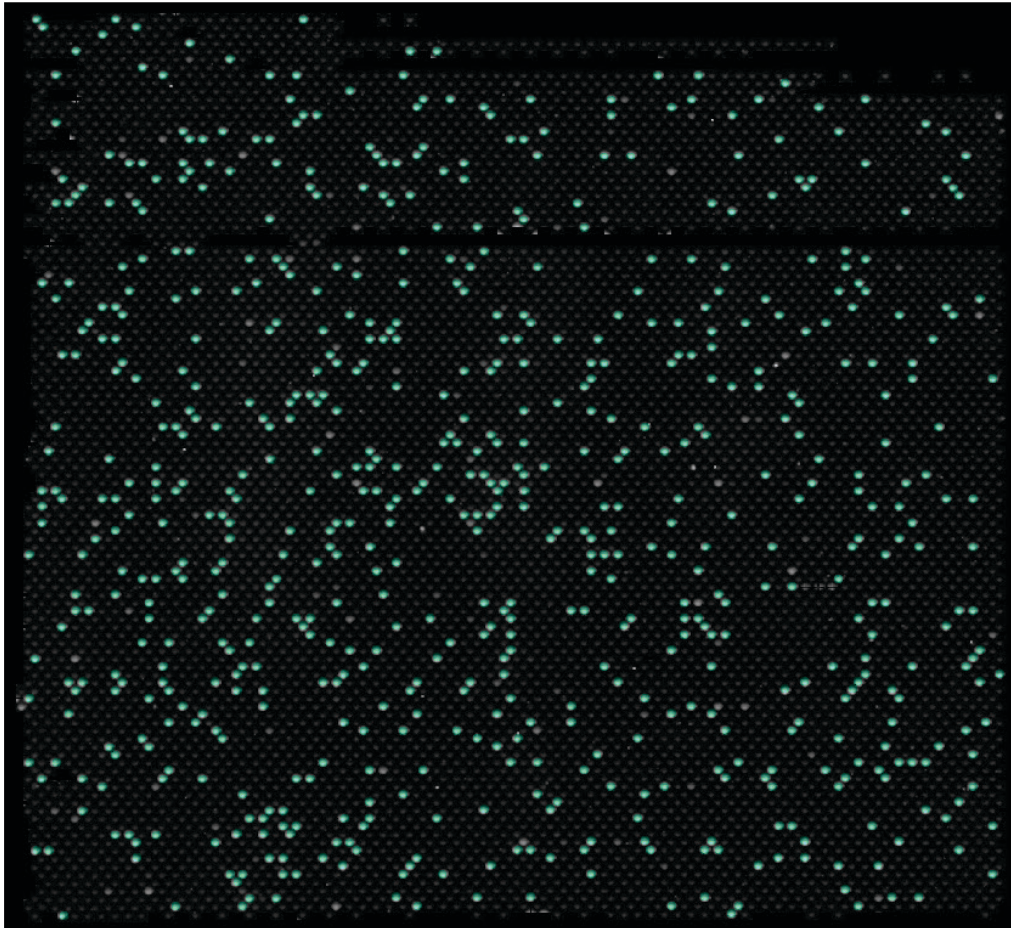

Signal map of an image showing areas of bad filling

6.7.8 Crosstalk Correction algorithm

Depending on the optical configuration of your QIAcuity instrument, you can detect up to two or five fluorescent channels. To compensate the spectral overlap between the fluorescent dyes, a crosstalk correction algorithm is implemented in the QIAcuity Software Suite. The correction is done automatically by the software and does not require any user action. The bleed-through signals are removed from the images and are not taken into account in the result analysis. The crosstalk correction is correcting an absolute value based on the RFU level of the neighbor channel.

Note: In case insufficient compensation or overcompensation is seen (e.g., as double negative bands), check the RFU level of positive signals of neighbor channels if saturated or very bright. By lowering the RFU level of positive signals, the insufficient compensation or overcompensation might be reduced.

6.7.9 General analysis options

Selecting wells for analysis

- To select multiple wells at the same time, click the individual wells or click one well then drag your mouse until all wells are selected.
- To select all wells, click **Select all**.
- To remove a selected well, click the well.
- To remove all selected wells, click **Unselect all**.

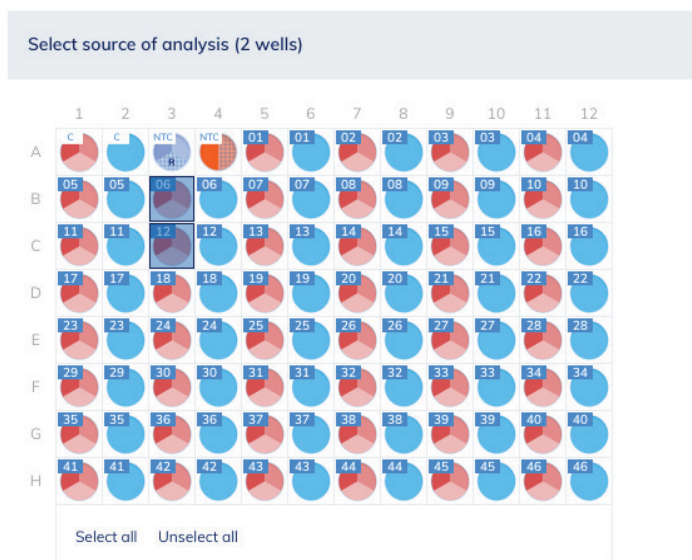

Plate table with available wells.

To view more information about an individual well, double-click the well in the plate layout. The Well Information dialog box appears. Click **OK** to close the dialog box.

Well Information (A10)
✕

04

Reaction mix name EGFR_COSM6254

Sample ID 04

Sample name Sample 4 0.5%

Index	Target	IC	Dye	Channel
1	Mutation	-	FAM	● Green
2	Wildtype	-	HEX	● Yellow
3	-	-	-	-
4	-	-	-	-
5	-	-	-	-

OK

Hyperwells

To achieve higher accuracy, multiple wells can be grouped together and analyzed as a single well. To define a hyperwell, select multiple wells with the same Reaction Mix and same Sample name.

	1	2	3
A	01	01	01
B	01	01	01
C	01	01	01
D	02	02	02
E	02	C	C
F	C	C	NTC
G	NTC	NTC	
H			

Select all
Unselect all
Group as hyperwell ⓘ
Ungroup hyperwell

Then, click **Group as hyperwell** from the menu below or right-click and select **Group as hyperwell** from the context menu.

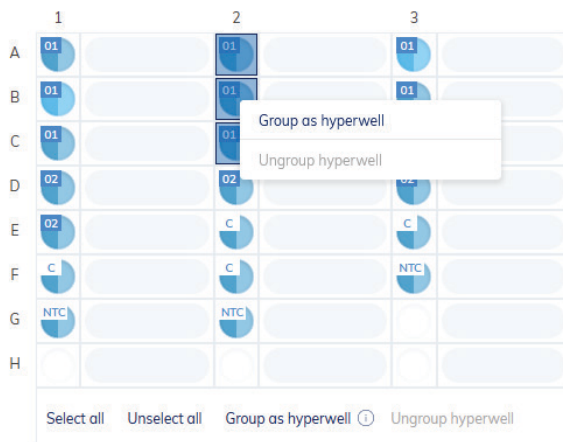

To ungroup the hyperwell, select the hyperwell and click **Ungroup hyperwell** from the menu below or from the context menu.

For the analysis, hyperwells are treated as a single well but with a larger number of partitions. This may be helpful for rare event detection if the sample volume to be analyzed exceeds the volume that can be loaded into a single well. Results from all wells coupled into a hyperwell will be aggregated and presented as a result from a single well.

Details about CI calculation and concentration determination in hyperwells are described in the *QIAcuity User Manual Extension: QIAcuity Application Guide* available at www.qiagen.com.

Hyperwells can be selected for Absolute Quantification, Mutation Detection, and Genome Editing, Copy Number Variation, and Gene Expression analysis.

6.7.10 Using hyperwells in copy number variation and gene expression analysis

1. Select reference sample from the drop-down list.

Reference sample *

Reference sample * Copies/genome *

01 sample_0101

Target of interest *

Select target from the list

Reference selection *

Select target of interest first

Reference target(s) *

Select at least one target from the list

2. Then, enter the number of copies/genome. You can choose the value between 1 and 99.

Select imaging step

1 2

Reference sample * Copies/genome *

01 sample_0101

Target of interest *

mutant_A (Yellow)

Reference selection *

Select reference

Reference target(s) *

wildtype_1 (Green)

Show results

Reference selection defines wells, hyperwells that have the same sample ID for the selected reference sample. Select one that you would like to analyze.

3. Select target of interest from the drop-down list.

Reference sample * Copies/genome *

(i)

Target of interest *

(i)

Reference selection *

(i)

Reference target(s) *

(i)

4. Reference selection is now unavailable because you have not selected the wells/hyperwells with the same sample ID for the chosen reference sample.
5. Click on the reference target drop-down list, and select one or more targets.
6. Click the **show results** button to get results.

Below you can find the example when the reference selection is available. In this case, well A2 and hyperwell (A3, B3) have the same sample ID for the selected reference sample.

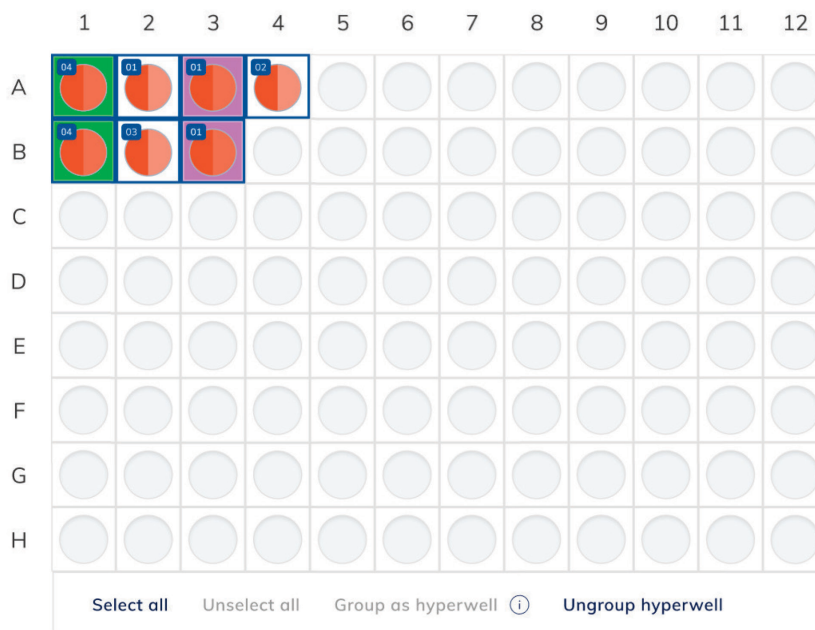

1. First select reference sample. In this case, the user has selected sample ID 01 "patient 01".

Reference sample*

01 patient 01 ▼ ⓘ

2. Enter the copies/genome. You can choose the value between 1 to 99. In this case, the user enters "10".

Reference sample* Copies / genome*

01 patient 01 ▼ ⓘ 10 ⓘ

3. Then, select the target of interest. In the example below, the user has chosen SARS-COV-2 with channel Green.

Target of interest*

01 SARS-COV-2 ● Green ▼ ⓘ

4. The reference selection is available. From the drop-down list are two options: "01 HW2" (hyperwell with selected wells: A3, B3) or "non-hyperwell, all replicates". In this case, the user has selected "01 HW2".

Reference selection*

01 HW2 ▼ ⓘ

5. Next, please select reference target(s). Here, the user has chosen ERBB2 with channel Yellow.

Reference target(s)*

01 ERBB2 ● Yellow ▼ ⓘ

6. If all fields have been selected, you can click the **Show results** button.

Multiple imaging steps

If the plate was configured with multiple imaging steps, you can select the one used for analysis.

To select the imaging step, click one of the available boxes indicated by this icon:  . The channels that were activated in the selected imaging step are shown below the imaging step buttons, along with the duration and gain.

Important: When switching imaging steps, the application will ask to ungroup existing hyperwells. All wells linked as hyperwells will be ungrouped as individual wells.

Note: If an imaging step failed during the run or images are of low quality, a message is shown by moving the mouse over the camera icon to indicate that the results might be incorrect. Furthermore, error messages are indicated with a red box around the image step icon, warnings with a yellow box.

Note: If the images are of good quality, but not all the wells have been filled, the following error appears.

 For some wells in this step, images are of low quality and we can't obtain the results for them. Those wells are unavailable for analysis. Try re-imaging the plate to fix this issue.

Select imaging step















 1	 2	 3	 4	 5	 6	 7
Green (2500ms / 22,2)				Red (2500ms / 22,2)		
Yellow (2500ms / 22,2)				Crimson (2500ms / 22,2)		
Orange (2500ms / 22,2)						

Diagram options

There are several tools related to the diagrams and charts that enable you to adjust the view and download the chart you want to view. To access the tools, point to a diagram. Table 15 shows the toolbar buttons and their corresponding functions.

Table 15. Diagram toolbar buttons

Download plot		Downloads the plot as an SVG or PNG file
Pan		Changes the perspective of the graph Moves along the x-axis, y-axis, or both
Zoom		Enables you to select a part of the diagram to zoom into To reset the zoom, double-click the diagram.
Zoom in		Zooms in the diagram To reset the zoom, double-click the diagram.
Zoom out		Zooms out the diagram To reset the zoom, double-click the diagram.
Reset axes		Resets the axes after the view is panned
Box select		Enables you to select a part of the diagram
Lasso partitions assignments		Enables you to select a freehand part of diagram

Note: Each diagram type contains a different set of toolbar buttons.

Range sliders

If more wells are selected for the analysis than fit on a chart, some charts such as concentration diagrams or point diagrams, offer the additional option of a range slider. This tool lets you view the data that does not fit on the diagram. You can also adjust the range of data that is shown to see more information at the same time.

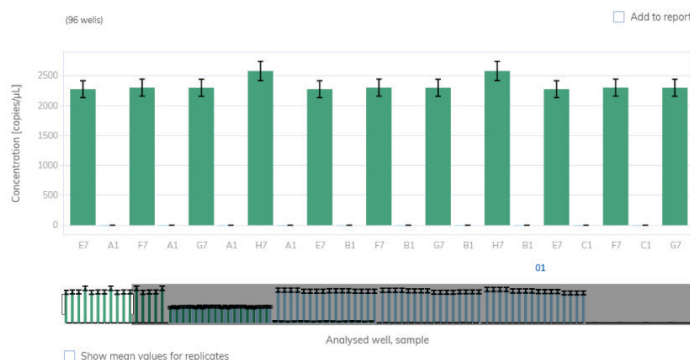

Example of a range slider below a chart.

The highlighted area of the slider shows the portion of the chart that is currently displayed. The gray part of the slider is a preview of the rest of the chart.

To view another part of a diagram, click the highlighted area of the slider and drag to the part that you want to view.

To adjust the range of the displayed data, click one of the handlebars on the left or right side of the highlighted area and drag until you reach your preferred range.

6.7.11 Absolute quantification

The **Absolute Quantification** tab is the first tab in the Analysis environment. After selecting the wells to be analyzed, you can view lists, signal maps, heatmaps, histograms, 1D scatterplots, 2D scatterplots, and concentration diagrams in this tab.

Setting up an absolute quantification analysis

1. Click the applicable wells in the plate layout. For more information, refer to [Selecting wells for analysis](#).

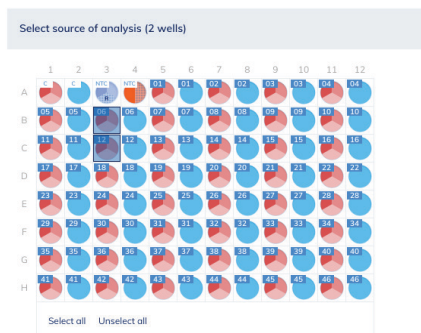

2. To select the analysis type, click **Target** or **Channel**. If there are no reaction mixes available on the plate, the Target button is disabled.
3. To analyze the plate by targets, select the targets from the **Select Targets** list. You can select one or more targets from the list. To select all targets, click `.

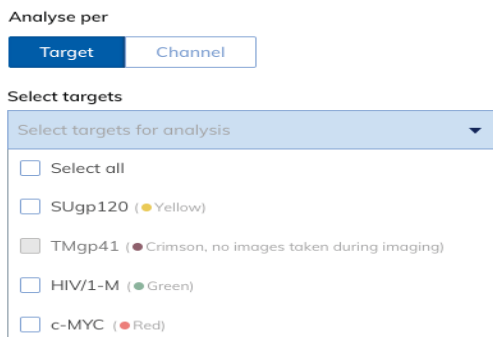

- Click **Show results** to view the results of the analysis.
- To analyze the plate by channels, check the boxes of the corresponding channel color to select the relevant channels. If images are not taken for a channel, the channel becomes disabled.

Analyse per

Target Channel

Select channels

Green Red

Yellow Crimson

Orange

- Click **Show results** to view the results of the analysis.
- The results are divided into several tabs. To view the contents of the tab, click the tab title.

Note: For the result analysis at least one well and a target or channel must be selected.

List tab for absolute quantification

The List tab contains a table with an overview of the analyzed wells. The following columns are available in the table:

- Well ID** – like A1, B2
- Reaction mix** – This column contains the icon and the name of the reaction mix.
- Target or Channel** – Depending on the settings defined when selecting a source, this column shows the target or channel names and its corresponding color.
- Sample/NTC/Control** – This column shows the sample, NTC, or control name with its corresponding icon that identifies the sample or indicates whether the entry is an NTC or control.
- Concentration (copies/μl)** – This column shows the concentration assigned to each target or channel per well.
- CI (95%)** – This column shows the value of the confidence interval at a 95% confidence level
- Partitions (Valid, Positive, Negative)** – This column shows the number of valid, positive, and negative partitions per well and the target or channel.
- Threshold** – This column shows the current threshold. If lasso is used, then “variable” is displayed instead of threshold value.

List Signalmap Heatmap Histogram 1D Scatterplot 2D Scatterplot Concentration diagram

Add to report Show mean values for replicates



Sample/NTC/Control	Reaction Mix	Channel	IC	Control type	Concentration * copies/μL	CI (95%)	Partitions		Threshold	
							valid	positive negative		
D5 patient04	PI	Green	-	--	678.6	4.7%	7646	1530	6116	95.72
		Yellow	-	--	14.34	33.1%	7646	36	7610	42.08
D6 patient04	PI	Green	-	--	678.6	4.7%	7646	1530	6116	95.72
		Yellow	-	--	14.34	33.1%	7646	36	7610	42.08
D7 patient04	PI	Green	-	--	678.6	4.7%	7646	1530	6116	95.72
		Yellow	-	--	14.34	33.1%	7646	36	7610	42.08

Saturated signals are marked with a  symbol next to the concentration value in the list view. Furthermore, a dedicated information message is shown above the diagram. For more information regarding saturated signals please refer to Image quality control.

List Signomap Heatmap Histogram 1D Scatterplot 2D Scatterplot Concentration diagram

 This signal for channels Green, Cyan, Orange, Red reached the saturation in wells A1, A3, A3, A4, A5, A6, A7, A8, A9, A10, A11, A12, B1, B2, B3, B4, B5, B6, B7, B8, B9, B10, B11, B12, C1, C2, C3, C4, C5, C6, C7, C8, C9, C10, C11, C12, D1, D2, D3, D4, D5, D6, D7, D8, D9, D10, D11, D12, E1, E2, E3, E4, E5, E6, E7, E8, E9, E10, E11, E12, F1, F2, F3, F4, F5, F6, F7, F8, F9, F10, F11, F12, G1, G2, G3, G4, G5, G6, G7, G8, G9, G10, G11, G12, H1, H2, H3, H4, H5, H6, H7, H8, H9, H10, H11, H12. Try re-imaging the plate with reduced exposure time and gain settings to fix this issue.

Add to report Show mean values for replicates Export to CSV...

Sample/NTC/Control	Reaction mix	Target	IC	Control type	Concentration * copies/µl	CI (%)	Partitions valid	Partitions		Threshold
								positive	negative	
A1  Sample_2101	mixes_1	wildtype_1	-	-	483.6	5.0%	692	1037	5035	101.28
A2  Sample_2101	mixes_1	wildtype_1	-	-	6.000	-	7245	0	7245	239.17
A3  Sample_2101	mixes_1	wildtype_1	-	-	208.1	5.3%	6345	433	5912	120.03

Current results

If you want to export current results of analysis please follow the instruction below.

1. Select wells that you want to get results for.
2. Choose if you want to analyze per Target or per Channel by clicking proper tab, and select targets or channels you are interested in.
3. Click on the **Show results** button.
4. In the List tab, above the table, on the right-hand side you can see the **Export to CSV...** option.
5. Click on the **Export to CSV** option and select the **Current results** option.
6. Remember that data in CSV reflects data from List View are structured as follows:
 - Well – identifier of well
 - Sample/NTC/Control – name of Sample/NTC/Control
 - Reaction mix – name of reaction mix
 - Channel – channel name or Target – target name
 - IC – internal control if selected
 - Control Type – control type
 - Concentration (copies/ µl) – calculated concentration
 - CI (%) – confidence interval parameter
 - Partitions (valid) – number of valid partitions
 - Partitions (positive) – number of positive partitions
 - Partitions (negative) – number of negative partitions
 - Threshold – value of threshold

Multiple occupancy

If you want to export a number of multiple occupancies for multiplex reaction, please follow the instructions below.

1. Select wells that you want to get results for.
2. Click on the Channels tab, and select channels you are interested in.
3. Click on the **Show results** button.
4. In the List tab, above the table, on the right-hand side, you can see the **Export to CSV...** option.
5. Click on the **Export to CSV** option and select the **Multiple occupancy** option.
6. Remember that data in CSV are structured as follows:
 - Well – identifier of well
 - Hyperwell – identifier of hyperwell if wells were grouped
 - Categories – names of channels
 - Group – identifier of channels from the Categories column, which are positive (+) and negative (-)
 - Count – number of valid partitions in a certain group
 - Total – total number of valid partitions in a well
 - Volume – cycled volume in a well (in microliters). Value is corrected by VPF if it is applied.

Table 16. Example for a multiple occupancy export file

Well	Hyperwell	Categories	Group	Count	Total	Volume
A1	HW1	Green-Yellow-Orange-Red-Crimson	+++++	2000	8000	2.89
A1	HW1	Green-Yellow-Orange-Red-Crimson	+++--	200	8000	2.89

Note: The amount of valid partitions may differ from list view because, for multi-occupancy output, only valid partitions across all selected channels are used as valid, whereas in list view, valid partitions are defined per channel.

RFU values

If you want to export relative fluorescence units per partitions for selected wells, please follow the instructions below.

1. Select wells that you want to get results for.
2. Click on the **Channels** tab, and select channels you are interested in.
3. Click on the **Show results** button.
4. In the List tab, above the table, on the right-hand side you can see the **Export to CSV...** option.
5. Click on the **Export to CSV** option and select the **RFU values** option.
6. Remember that data in CSV are structured as follows:

- Well – identifier of well
- Sample – identifier of sample
- Channel – first letter of channel on which picture was taken
- Cycled volume (µl) – well volume corrected by VPF
- Threshold – threshold value
- Partition – number by which a partition can be identified
- Is Invalid – code for invalidation reason (check mapping table code statuses, there can be a maximum 3 codes separated by a comma)

Status	Code
Poisson test – linear distribution issue Blistering (Poisson test)	1
Poisson test areas of too low/no positive partitions amplification)	2
Poisson test areas of too high positive partitions (Proportion test – over-amplification)	3 & 4
Reference partition not filled	5 & 9
Dust detected by different reasons	6, 7, 8
Artifacts founds	B & C

- IsPositive – information whenever a partition was marked as positive (1) or negative (0). For invalid partitions there is no information presented
- RFU – RFU values associated with partition. For invalid partitions there is no information present

7. Data will be exported to separate CSV files (one for each selected channel) and compressed into one zip file.

Note: Please be informed that due to some corrections provided by analysis models, sometimes there might be changes when comparing IsPositive column values with information obtained by comparing RFU values to threshold.

RFU values (compact)

This option is very similar to regular RFU report but redundant data in columns: Well, Sample, Channel, and Cycled volume in CSV file are removed to decrease the file size — same names or values in subsequent rows will only be shown once until the name of value has changed.

Replicates

Replicates of a sample are identified by having the same reaction mix and the same sample name. Replicates are detected automatically when the user assigns a sample to a well. If there is another well with the same sample name and reaction mix, this well is identified as a Replicate.

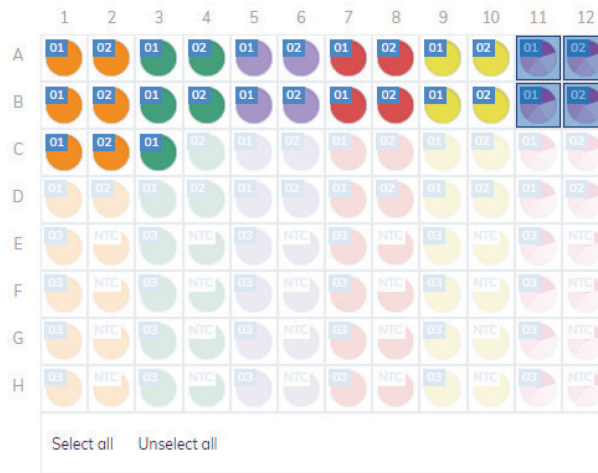

Analyze section with 2 Replicate groups (A11, B11) and (A12, B12).

Replicates are analyzed as separate wells but in addition the mean concentration value and the CI value of the mean concentration are provided on demand.

On the right side above the table there is a checkbox, which allows the user to show mean values for replicates in addition. By default, the button is unchecked, and results are displayed without mean values. When the button is checked the list still shows independent rows for each selected well, but replicates are grouped together. Replicates from the same group are next to each other in the list view. There are two additional columns indicating the mean values:

Mean concentration

Mean concentration for replicates is calculated as an average, i.e., the sum of concentrations multiplied with well-specific cycled volume of selected wells divided by the multiplication count of selected wells with the sum of cycled volumes.

$$\text{Formula for mean concentration (cp per } \mu\text{l)} \text{ of 2 replicates} = \frac{(c(1) * v(1) + c(2) * v(2))}{(v(1) + v(2))}$$

$$\text{Example for mean concentration (cp per } \mu\text{l)} \text{ of 2 replicates} = \frac{(6278 * 2.889 + 6411 * 2.773)}{(2.889 + 2.773)} = 6343 \text{ cp per } \mu\text{l}$$

CI (95%) — CI of mean concentration assumes that error between individual results has normal distribution. z is defined as 1.96. n = sample size (amount of replicates).

$$\text{CI for replicates} = \text{Standard deviation} * z \div \sqrt{\frac{n}{\text{Mean concentration of replicates}}}$$

List Signalmap Heatmap Histogram 1D Scatterplot 2D Scatterplot Concentration diagram

Add to report Show mean values for replicates Export to CSV...

Sample/NTC/Control	Reaction Mix	Channel	IC	Control type	Concentration * copies/μL		Mean concentration copies/μL		CI (95%)	Partitions solid	positive		negative	Threshold
A6 patient01	PL	Green	-	-	1226.5	3.4%	1226.5	0%	7646	2684	4962	30.60		
		Yellow	-	-	13.39	33.1%	13.39	0%					7646	36
A7 patient01	PL	Green	-	-	1226.5	3.4%	1226.5	0%	7646	2684	4962	30.60		
		Yellow	-	-	13.39	33.1%	13.39	0%					7646	36
A8 patient01	PL	Green	-	-	1226.5	3.4%	1226.5	0%	7646	2684	4962	30.60		
		Yellow	-	-	13.39	33.1%	13.39	0%					7646	36

List tab with selected mean values for replicates.

Signalmap tab for absolute quantification

The **Signalmap** tab provides positive partitions for target channels and valid partitions for the reference channel of selected wells. For each channel included in target or channel selection, one signal map view is created. The signal map views are sorted by channel position in imaging ("Green", "Yellow", "Orange", "Red", "Crimson"), separated by a horizontal line.

With this view the user can visually check the influence of threshold settings on the partition distribution and consider the impact of artefacts that he might have discovered in the source image view.

Each signal map represents the plate layout for a selected channel where only the images of the selected wells are loaded. Remaining wells are displayed as grey squares. When the image of a well could not be calculated by the algorithm, a placeholder image is shown. On hovering the mouse over the well, the user is informed that the signal map for this well could not be created.

The title of a signal map shows the channel name and in case that more than one well is selected also the number of selected wells.

When the user hovers with the mouse over a well, a tooltip is shown informing about the label of the given well and, if defined, about the associated target. On hovering the well image, the image is highlighted and the cursor changes to the zoom icon.

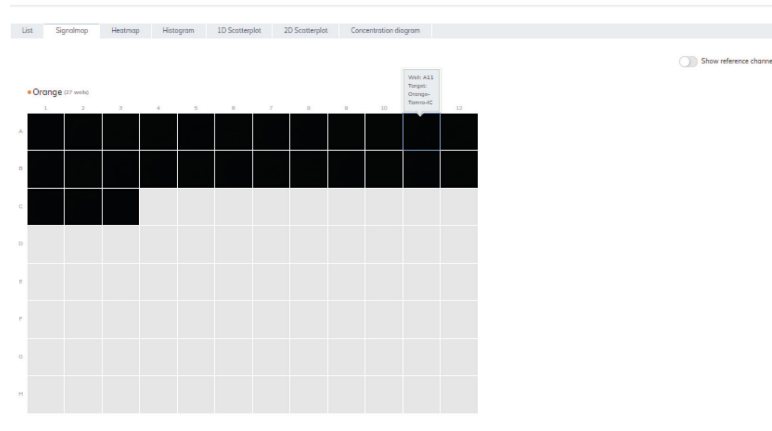

Signal map for a target channel.

On mouse-click, a modal window opens containing the well image providing following tool options on top of the right side.

- Zoom In
- Zoom out
- Download signal map of this well as picture
- Close zooming window

The Zoom-In and Zoom-Out feature is also possible using the mouse wheel. On top of the left side, the well ID, channel name, and if defined the associated target name are shown.

The Software Suite provides a signal map view for the reference channel, which is hidden by default. To view the signal map for the reference channel in addition, click Show reference channel. The functionality of the signal map view for the reference channel is analog to the signal map views of the target channels. Valid partitions are marked and highlighted with blue dots whereas positive partitions of target channels are marked and highlighted with green dots.

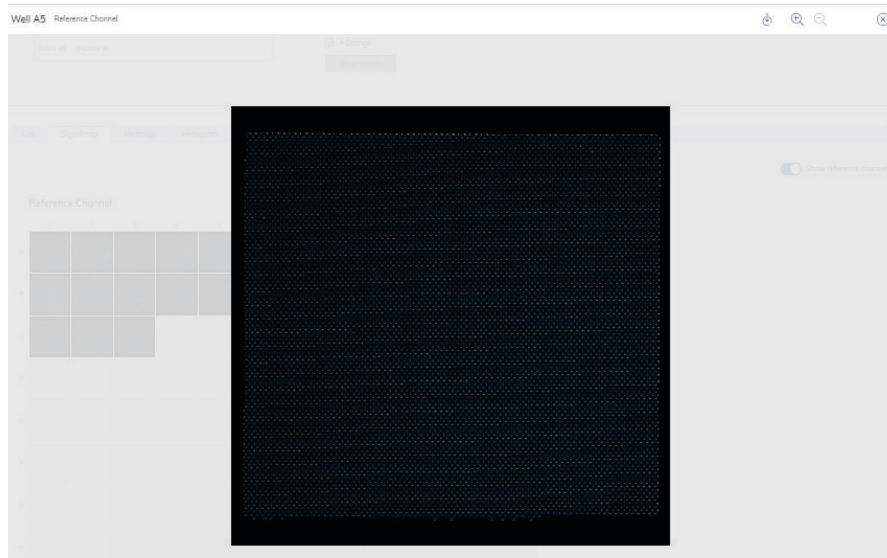

Zoom window for a well image of the reference channel.

Heatmap tab for absolute quantification

The **Heatmap** tab shows the concentration of the selected targets or channels in each well. The values of all selected wells are also displayed in this tab. Values for disabled wells are not displayed. One heatmap view is created for each selected target or channel. The heatmap views are sorted by channel position in imaging ("Green", "Yellow", "Orange", "Red", "Crimson"), separated by a horizontal line.

If the target or channel shown in a heatmap is not relevant to one or more wells, those wells do not have a value displayed and their background color is gray.

Move the pointer over a well getting further detailed information of the corresponding well.

To view an additional toolbar that enables actions related to the diagram, such as downloading the plot, hold the pointer over the diagram. For more details about the toolbar, refer to section Diagram options.

There are two views of each heatmap – the concentration view and the partitions view (see the following images). To switch between the views, click **Concentration** or **Partitions**.

Showing the mean concentration values for replicates in the concentration view click Show mean values for replicates. Mean values are not supported in the partition view. Therefore, the related check box is greyed out in the partition view and a meaningful information message is shown to the user.

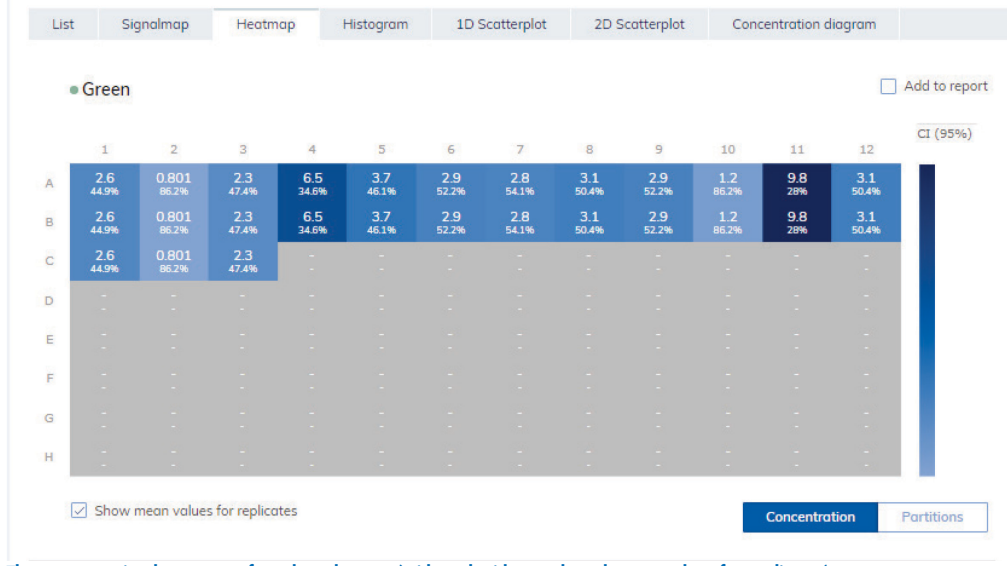
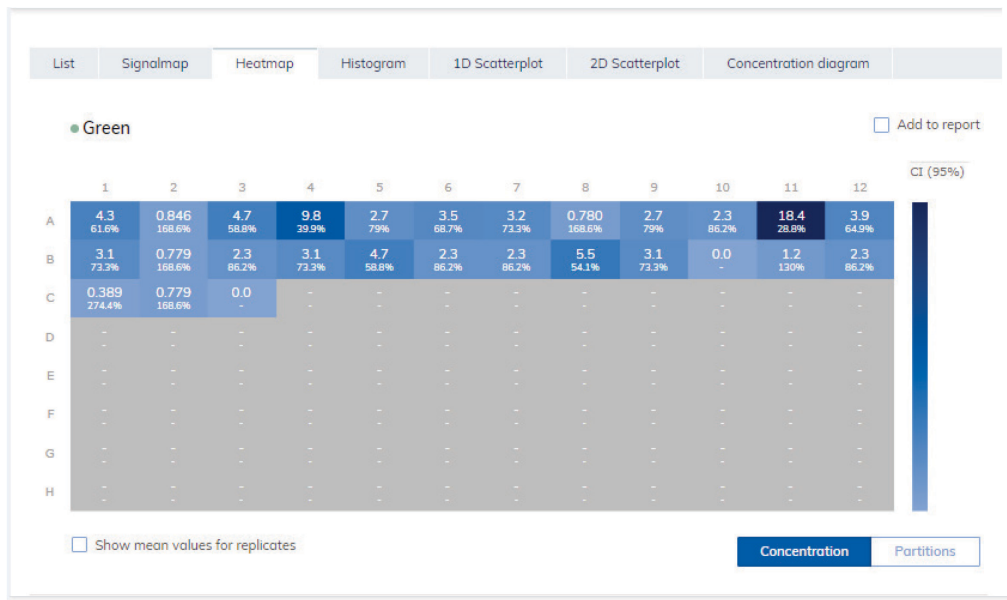

The concentration heatmaps of a selected target (with and without selected mean values for replicates).

- List
- Signalmap
- Heatmap
- Histogram
- 1D Scatterplot
- 2D Scatterplot
- Concentration diagram

● Green

Add to report

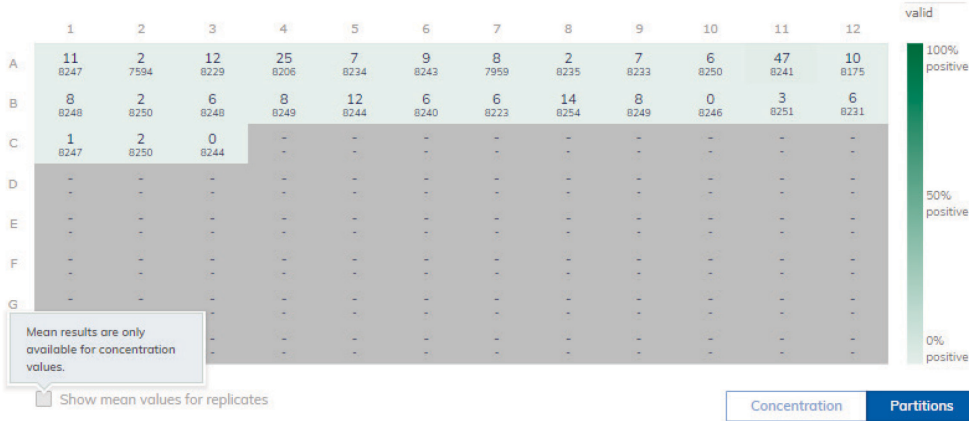

The partitions heatmap of a selected target.

To add any of the heatmaps to the report, click **Add to report** next to the relevant diagram. For more information on reports, see section Reports.

Heatmap for hyperwells

Yellow MM (1 hyperwell)

● Yellow

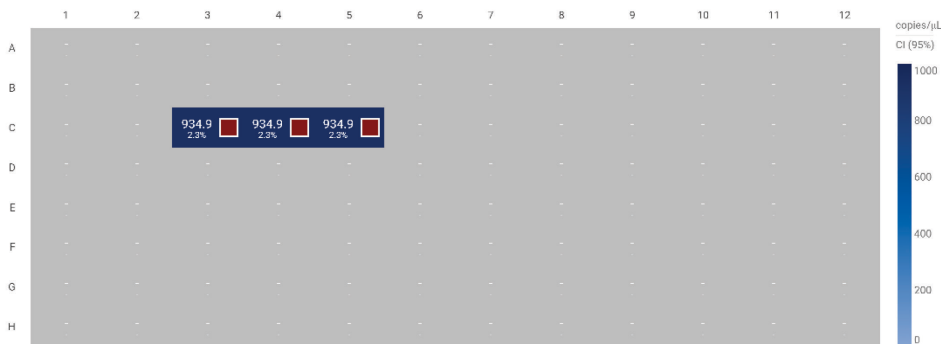

Histogram tab for absolute quantification

The Histogram tab displays graphs that visualize the fluorescence values of selected wells for the selected target or channel. One histogram view is created for each selected target or channel. The histograms are sorted by channel position in imaging ("Green", "Yellow", "Orange", "Red", "Crimson"), separated by a horizontal line.

Each histogram has two axes. The x-axis represents the relative fluorescence intensity. The y-axis represents the number of partitions having that fluorescence intensity. The values on the y-axis have two available scales – linear and logarithmic.

To view an additional toolbar that enables actions related to the diagram, such as downloading the plot, hold the pointer over the diagram. For more details about the toolbar, refer to section Diagram options.

The y-axis scale can be modified using the buttons located below each graph. The buttons are visible when you hold the pointer over a graph. To view the values on a linear scale, click **lin**. To view the values on a logarithmic scale, click **log10**.

Furthermore, the user can change the range of the x-axis by modifying the upper value of **the fluorescence intensity on the x-axis**. For this the user clicks on the right side of the x-axis which opens a text box. This text box is used to insert the new upper range of the **fluorescence intensity**. The view of the histogram is adapted accordingly. Resetting the x-axis to the default range is provided by using the related Reset Axes icon of the tool bar.

The **Threshold** field shows the threshold value of the fluorescence intensity that is used to distinguish between positive and negative calls. If only one source well is selected, the value of the threshold is shown in the **Threshold** field and on the graph as a red line. If multiple source wells are defined and their automatically calculated threshold values are different, a threshold value is initially not shown in the histogram.

There are two ways to change the threshold. The first one involves pointing to the chart, which triggers the appearance of a dotted line. Once the dotted line is in the appropriate spot, click the chart. The line becomes solid, and the threshold value is updated and displayed in the **Threshold** field. To change the value again using this method, click the red line and drag it to the appropriate spot. In addition to moving the line, you can also directly edit the value in the **Threshold** box. To apply the new value on that data, click **Recalculate** to trigger the recalculation of results.

Note: For a multi-well selection the user can't change the thresholds individually. The new threshold becomes valid for all selected source wells. In case the user would like to change thresholds individually he has to change the source selection to a single well selection

To reset the software to automatically recalculate the threshold, click **Automatic threshold** . Again, click **Recalculate** to apply the auto-threshold to the results.

If the user tries to exit the view of the histogram without confirming changes with recalculation button, a warning modal is shown.

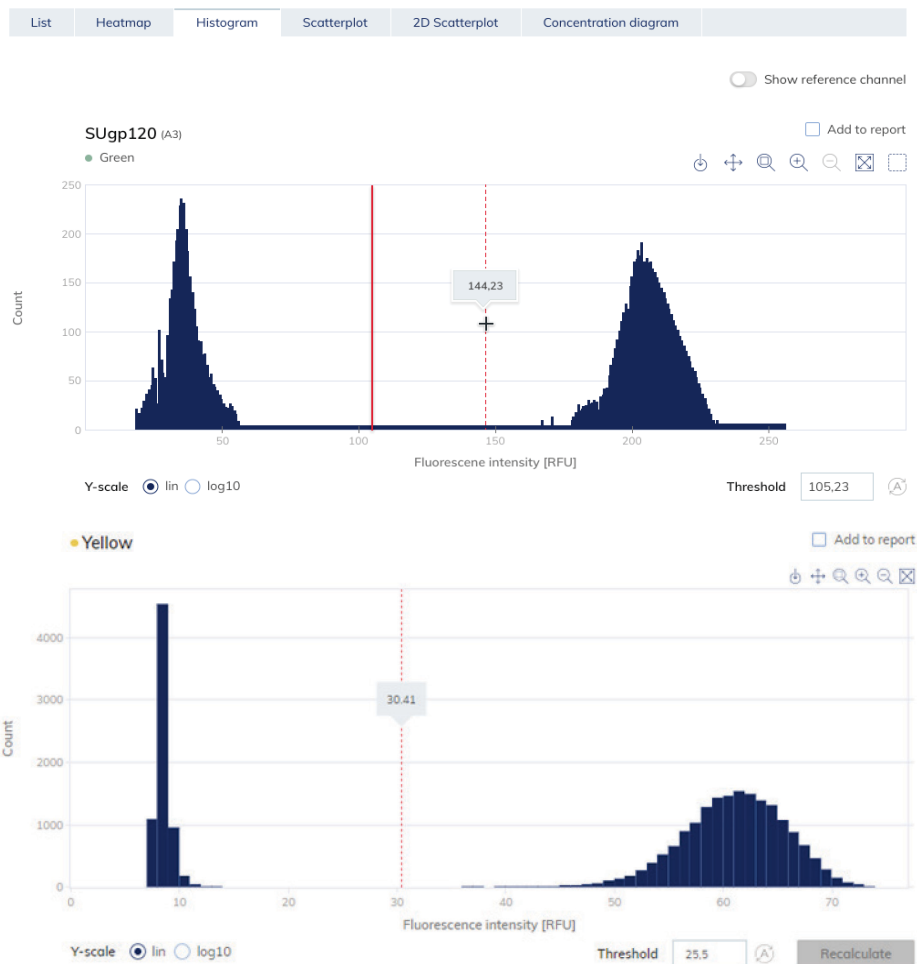

The Histogram tab.

To add any of the histograms to the report, click **Add to report** next to the relevant diagram. For more information on reports, see section Reports.

Reference channel

The Software Suite also provides a histogram for the reference channel, which is hidden by default. To view the histogram for the reference channel in addition, click **Show reference channel**. The title of this histogram indicates that the histogram is related to the reference channel. The graph for the reference channel provides the possibility to set a common lower as well as upper threshold to exclude partitions with too high/too low RFU. Setting the upper threshold is analog to histograms for target channels. Setting the lower threshold is only possible via chart. A dedicated text input field for the lower threshold is not provided. If multiple source wells are selected, the values are common for all wells. To apply the new threshold values for the analysis, click **Recalculate** to trigger the recalculation of results.

Lasso mode for partition assignment

Alternative of changing threshold values the user can assign partitions using a free hand selection in the 2D Scatterplot view (Lasso mode). When the user marked points by lasso for two channels or targets all thresholds on histogram for them disappear and can't be modified before switching back to threshold mode using the auto threshold button. When the user clicks recalculate button, changes in threshold selection affects 2D Scatterplot results as well.

Channels which are not used in 2D Scatterplot with lasso mode do still show the threshold mode in the histogram view.

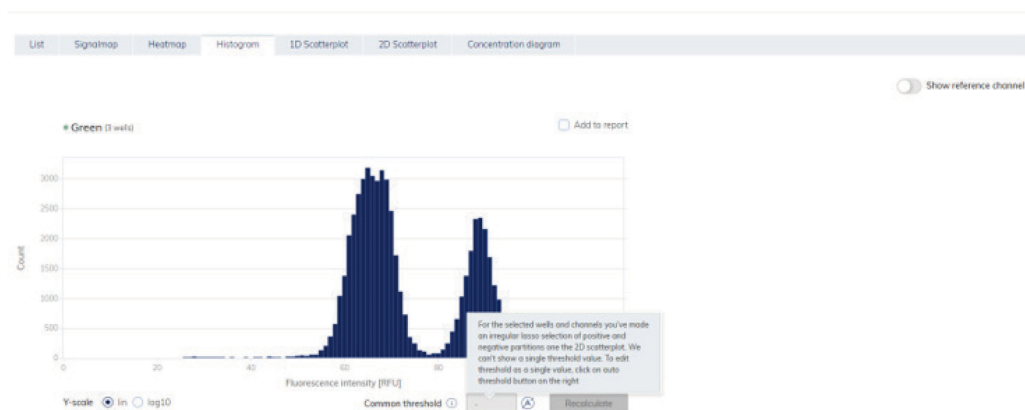

Selected channel with active lasso mode.

Refer to 2D Scatterplot tab for absolute quantification for more details regarding the assignment of partitions using the lasso mode.

1D Scatterplot tab for absolute quantification

The 1D Scatterplot tab shows one 1D Scatterplot view for each analyzed target or channel. If there are more than one scatterplot views, they are separated with a horizontal line. The 1D Scatterplot views are sorted by channel position in imaging ("Green", "Yellow", "Orange", "Red", "Crimson").

The title of a 1D Scatterplot view shows the related channel name including the dot channel color indicator, and if defined also the target name. If more than one well is selected also the number of wells is shown.

Thus, a 1D Scatterplot view has two axes. The x-axis represents the analyzed partitions, while the y-axis represents the relative fluorescence intensity of each partition.

A 1D Scatterplot view concentrates the diagrams for each selected well in a horizontal way separated by a vertical line (column indicator). For each well diagram a header is shown indicating the well coordination on the plate. A red line represents the

current threshold fluorescence intensity value (decimal value) that is used to distinguish between positive and negative partitions. Fluorescence values below the threshold are shown in grey, above the threshold in blue color.

In one 1D Scatterplot at maximum twelve well diagrams are shown on the page. The well diagrams are scaled according to the number of wells shown on one page. If there are more than seven selected wells, a horizontal scrollbar below the 1D Scatterplot is shown to the user to view the other wells.

To view an additional toolbar that enables you to perform actions related to the diagram, such as downloading the plot, zoom-in, zoom-out, hold the pointer over the diagram. For more details about the toolbar, refer to Diagram options.

The user can change the range of the y-axis by adjusting the value in the field Max value for the y-axis (RFU) and clicking **Save**. For resetting the y-axis to the default range, press the **Back to default** button. The view of the diagram is adapted accordingly.

Note: For RFU values below 60 it is recommended to increase the exposure time of corresponding channel/s and for RFU values below 150 it is recommended to decrease the exposure time of corresponding channel/s.

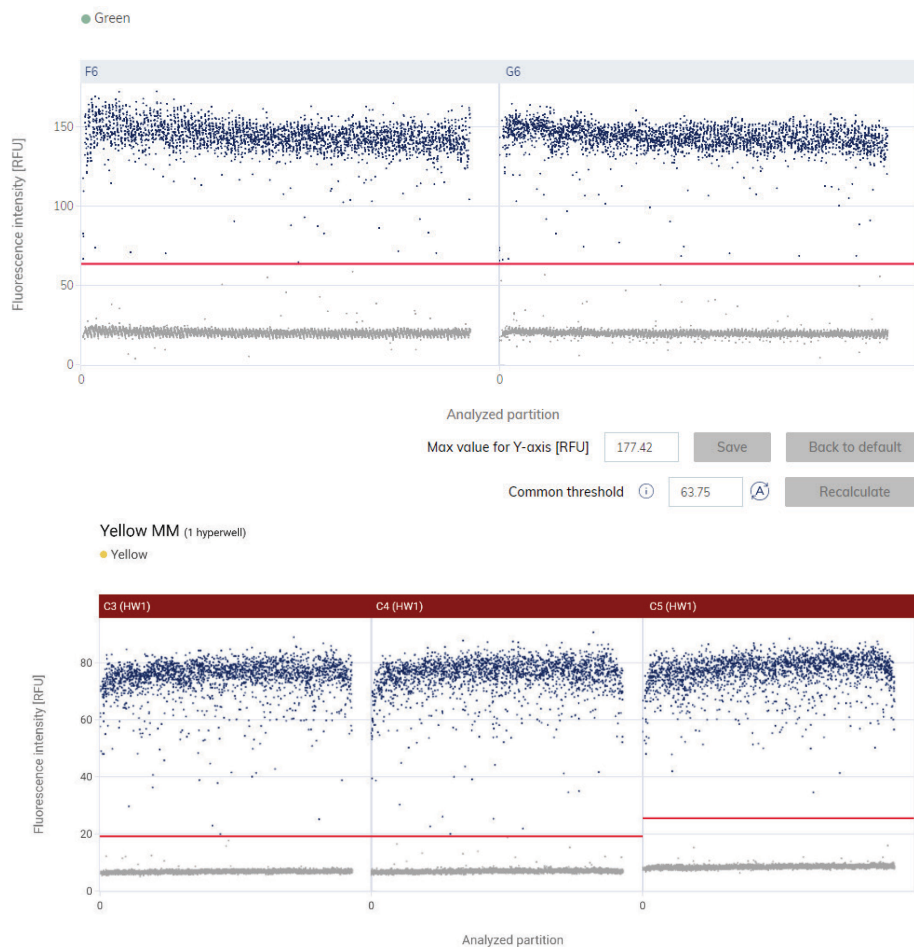

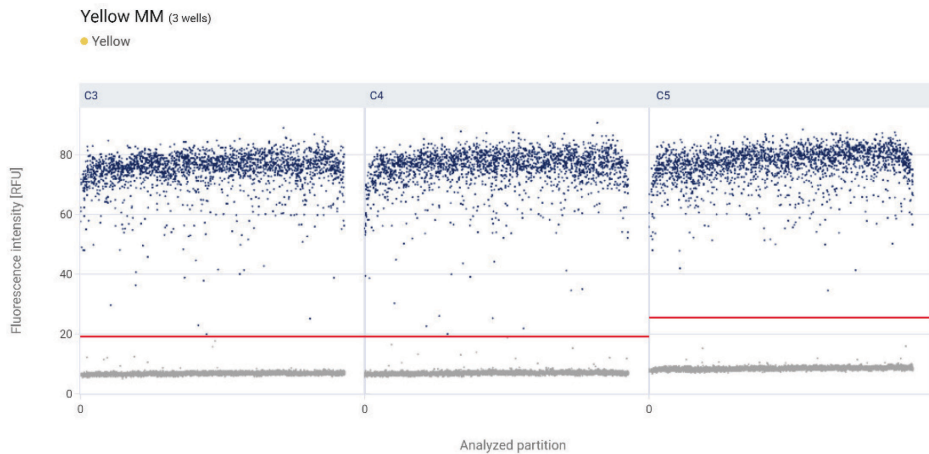

To open an individual plot, click on the appropriate header of the 1D Scatterplot.

Changing the threshold individually per well

1. To change the threshold individually per well, click on the appropriate header of the well in the 1D Scatterplot view. A window opens and the threshold can be changed by pointing over the chart, which triggers the appearance of a dotted line.
2. Once the dotted line is in the appropriate spot, click the chart. The line becomes solid, and the threshold value is updated and shown in the **Threshold** field.
3. To change the value again using this method, click the red line, and drag it to the appropriate spot. Alternatively, you can also directly edit the value in the **Threshold** field. Use the auto-threshold button  to set the threshold to the value, which is calculated by the analysis algorithm.

Note: The Threshold field and the auto Threshold button become only visible by moving the pointer in the range of the well diagram.

4. Click **Recalculate** to trigger the re-analysis of data and to close the window. Click **Cancel** to close the window without any changes.

Note: To add a single well diagram to the report, click **Add to report**. For more information on reports, see Reports.

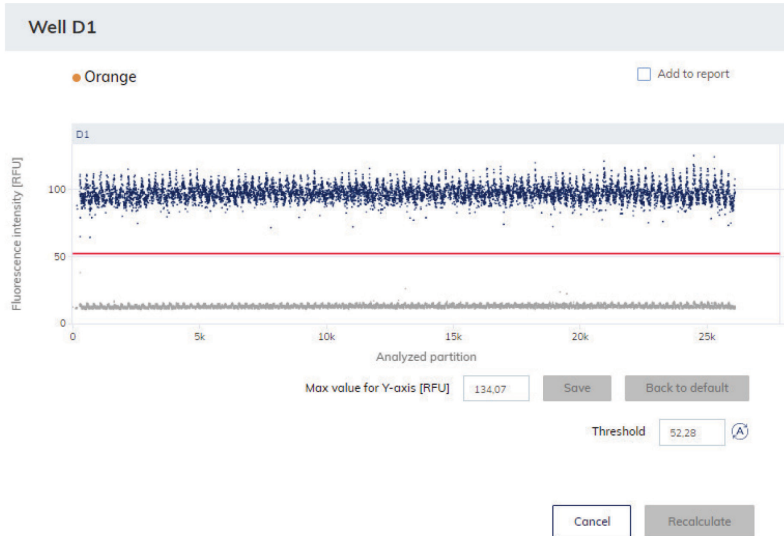

Changing the thresholds for all selected wells (Common threshold)

The 1D Scatterplot view provides an option to set a common threshold value for all associated wells using the Common threshold input field. Click the **Recalculate** button to trigger the re-analysis of data

Use the **Auto-threshold** button to re-set the threshold to the values, which is calculated by the analysis algorithm for each well. Click the **Recalculate** button to trigger the re-analysis of data.

If you change thresholds and wants to leave the 1D Scatterplot view without triggering the **Recalculate** button a appropriate warning message windows opens. You can continue ignoring your changes or stay in the 1D Scatterplot view.

The Common threshold input field, auto-threshold icon and recalculation button are only shown when the mouse is in the range of the diagram chart region.

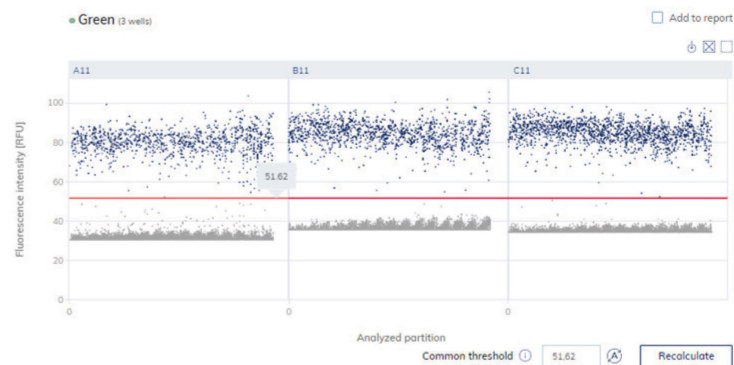

The 1D Scatterplot view with Common threshold.

To add any of the 1D Scatterplot views to the report, click **Add to report** next to the relevant view. For more information on reports, see Reports.

Reference channel

The Software Suite also provides a 1D Scatterplot view for the reference channel, which is hidden by default. To view the 1D Scatterplot for the reference channel in addition, click Show reference channel. The title of this 1D Scatterplot view indicates that the 1D Scatterplot is related to the reference channel. The graph for the reference channel provides the possibility to set a lower as well as an upper threshold to exclude partitions with too high/too low RFU. Setting the thresholds (individually per well or common lower and upper threshold for all selected wells) is analog to 1D Scatterplots for target channels. To apply the new threshold values for the analysis, click Recalculate. The 1D Scatterplot for the reference channel uses the same functions as the 1D Scatterplot views for non-reference channels.

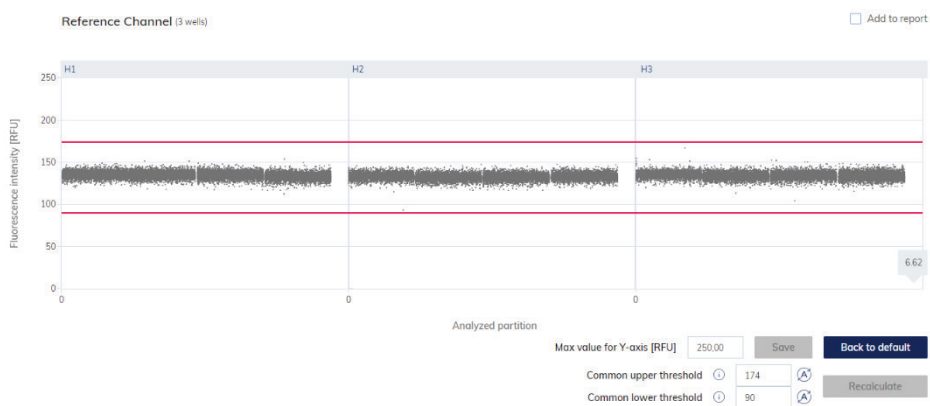

1D Scatterplot for the reference channel.

Lasso mode for partition assignment

Alternative of changing threshold values the user can assign partitions using a free hand selection in the 2D Scatterplot view (Lasso mode). When the user marked points by lasso for two channels or targets all thresholds on 1D Scatterplot for them disappear and can't be modified before switching back to threshold mode using the **Auto-threshold** button. When the user clicks recalculate button, changes in threshold selection affects 2D Scatterplot results as well.

Channels which are not used in 2D Scatterplot with lasso mode do still show the threshold mode in the 1D Scatterplot view.

Refer to 2D Scatterplot tab for absolute quantification for more details regarding the assignment of partitions using the lasso mode.

2D Scatterplot tab for absolute quantification

The 2D Scatterplot tab shows a 2D Scatterplot view that displays the fluorescence intensity from two selected channels or targets, allowing for a comparison and evaluation of the fluorescence from two sources.

To create a 2D Scatterplot, assign targets or channels to the x-axis and y-axis using the drop-down menus. When 2 of the selected sources for analysis are assigned, the 2D Scatterplot view is displayed. The axes represent the value of fluorescence intensity. The ranges of the axis are aligned with the maximal values presented from 0 to maximal fluorescence intensity of selected channel measured. The user can change the range of the x-axis and the y-axis by modifying the upper value of the **fluorescence intensity on the x-axis and the y-axis**. For this, the user adjusts the value in the field to Max value for the x-axis (RFU) or Max value for the y-axis [RFU] and press Save. Resetting the x-axis and the y-axis to the default range is provided by using the **Back to Default** button.

The Application also presents number of double positives (++) and double negatives (--), and number of partitions that are positives on one channel and negative on the other (+-, -+). To view updated results after changing threshold, click the **Recalculate** button.

To view an additional toolbar that enables you to perform actions related to the 2D Scatterplot view, such as downloading the plot, hold the pointer over the diagram. For more details about the toolbar, refer to Diagram options.

The Common **threshold** field for each axis shows the Common threshold value for each selected well of the fluorescence intensity that is used to distinguish between positive and negative partitions. If only one source well is selected, the values of the thresholds for the targets or channels on each axis are shown in the Common **threshold** fields and on the graph in the form of red lines. If multiple source wells are defined and their automatically calculated threshold values are different, a Common threshold value is initially not shown.

Setting the Common thresholds for all selected wells and each axis (channel)

The 2D Scatterplot view provides an option to set a common threshold value for the x-axis and y-axis for all associated wells. There are two ways to change the threshold. The first one involves pointing to the chart, which triggers the appearance of two perpendicular dotted lines. Once the dotted lines are in the appropriate spot, click the chart. The lines become solid, and the threshold value is updated, and shown in the **Threshold** field. To change the value again using this method, click one of the red lines, and drag it to the appropriate spot. If needed, repeat this step with the second line. In addition to moving the lines, you can also directly edit the value in the Common **threshold** field of the associated axis. Click the **Recalculate** button to trigger the re-analysis of data.

For each partition point the assignment to its group (++, +-, -+, or --) is derived from the threshold values. The partition number of each group is displayed on the top right, next to the diagram. The color of the point that represents the partition fluorescence measurement is assigned according to the group. A legend is shown on the left side below the 2D Scatterplot view:

- On the 2D Scatterplot, only valid partitions are shown.
- **Dark blue:** Partition is assigned for x-axis and y-axis channel as positive (++)
- **Orange:** Partition is assigned to x-axis channel as negative and for y-axis channel as positive (-+).
- **Light blue:** Partition is assigned to x-axis channel as positive and for y-axis channel as negative (+-).
- **Grey:** Partition is assigned for x-axis and y-axis channel as negative (--)
- The number of invalid partitions is shown in the legend at the right-hand side.
Invalid partitions on X mean the number of invalid partitions assigned to the x-axis.
Invalid partitions on Y mean the number of invalid partitions assigned to the y-axis.

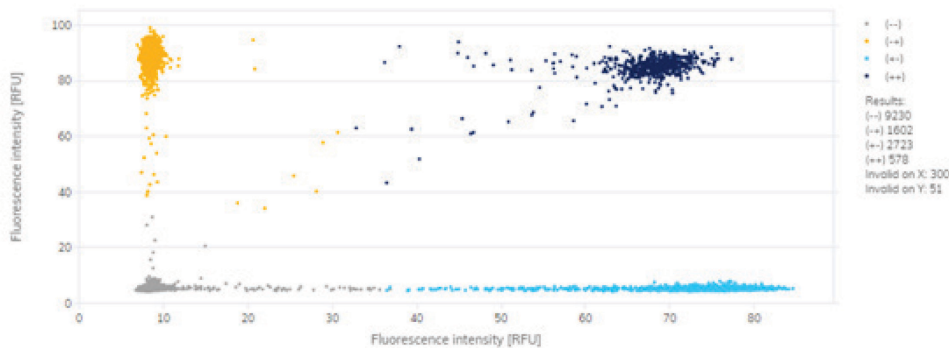

2D Scatterplot view with 2 Common thresholds.

Assigning partitions to a group using free hand (Lasso mode)

The user can select Lasso partitions measurement dots with a free hand mode, so that he can use a more precise way to assign partitions to the group they should belong to. The lasso is available in menu above the diagram on hover. When the user clicks lasso icon () he can first select the group (++, +-, --, or --) to which partitions should be assigned using the free hand mode. The points selection is additive. User can add points to the group he selected. If user assigns one group to a point and afterwards assigns another one, the last one is valid.

After selecting points by lasso, the user can set thresholds only by clicking the auto-threshold icon. Clicking this icon reactivates the threshold behavior. The user can use either the lasso mode or threshold setting. A combination of both is not possible. When thresholds are changed and not confirmed by clicking the **Recalculate** button, and if some partitions are selected through lasso mode and recalculated, the threshold values are ignored.

Note: Lasso selection in 2D Scatterplot affects also histogram and 1D Scatterplots views. For details refer to chapters Histogram tab for absolute quantification and 1D Scatterplot tab for absolute quantification.

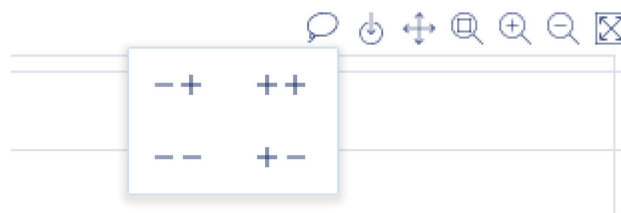

2D Scatterplot – Lasso mode – Group selection before free-hand assignment.

Use the **Auto-threshold** button for each axis to re-set the threshold to the values, which is calculated by the analysis algorithm for each well. Click the **Recalculate** button to trigger the re-analysis of data.

If you change Common thresholds or the assignment of partitions using the Lasso mode and wants to leave the 2D Scatterplot view without triggering the **Recalculate** button a appropriate warning message windows opens. You can continue ignoring your changes or stay in the 2D Scatterplot view.

To add the 2D scatterplot to the report, click **Add to report**. For more information on reports, see section Reports.

Concentration diagram tab for absolute quantification

The Concentration Diagram tab shows the diagrams that display the distribution of concentration values and confidence intervals. One diagram is created for each selected target or channel. A concentration diagram has two axes. The x-axis shows the analyzed wells, and the y-axis represents the concentration values for the selected targets or channels of each well. The values on the y-axis have two available scales – linear and logarithmic.

To view an additional toolbar that enables you to perform actions related to the diagram, such as downloading the plot, hold the pointer over the diagram. For more details about the toolbar, refer to section Diagram options.

The y-axis scale can be modified using the buttons located below each graph. The buttons are visible when you hold the pointer over a graph. To view the values on a linear scale, click **lin**. To view the values on a logarithmic scale, click **log10**.

Each diagram presents two values for each well – the concentration value, displayed as a bar, and the confidence interval, displayed as an error bar. To view the exact values, point to one of the bars. After a concentration diagram loads, the first 32 wells are shown in the diagram. To view other wells, use the slider located below the diagram.

To view the mean values for replicates on the diagram, click **Show mean values for replicates**. In this case one bar is shown for a replicate group showing the mean concentration value and the mean CI value of the replicate group. To view exact values and a list of wells belonging to the replicate group point to the associated bar.

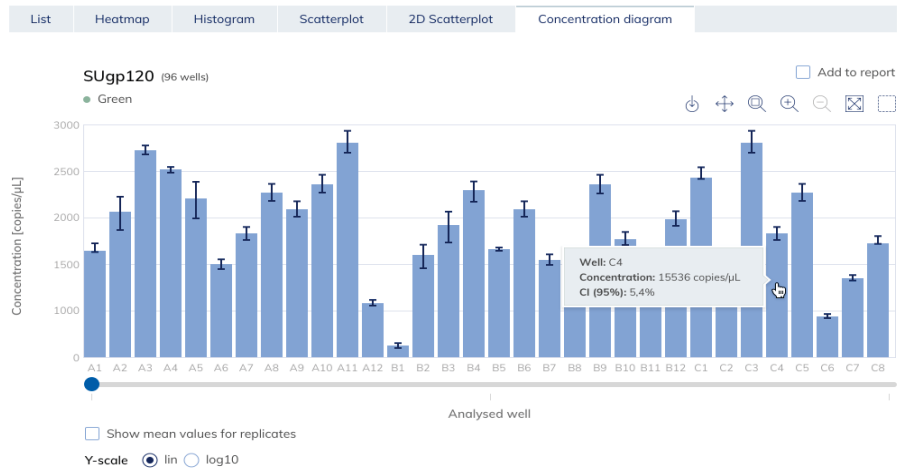

To add any of the concentration diagrams to the report, click **Add to report** next to the relevant diagram. For more information on reports, see section Reports.

Mutation detection

The Plate Analysis environment of the Software Suite includes the Mutation Detection tab. Mutation Detection analysis is based on the concentrations (see Absolute quantification). To use Mutation detection, the definition of targets in the reaction mixes and samples is mandatory. For more information, see section Setting up an experiment.

The Mutation Detection tab is used to show the results of analyzing plate contents to detect mutations in the samples. The analysis results are put into list views, heatmaps, point diagrams, and concentration diagrams.

Note: Saving of mutation detection tests is not available.

Setting up a mutation detection analysis

1. Click the relevant wells in the Select wells pane. For more information, see Selecting wells for analysis.

Select source of mutation detection (3 wells)

Select imaging step

Wild type target*
Select target from the list

Mutant target*
Select target from the list

Show results

Select all Unselect all Group as hyperwell Ungroup hyperwell

2. Select the applicable wild type target from the **Wild type target** list.
3. Select the applicable mutant target from the **Mutant target** list.
4. To view the results of the analysis, click **Show results**.
5. The results are divided into several tabs. To view the contents of the tab, click the tab title.

List tab for mutation detection

The List tab contains a table with an overview of the analyzed wells. The following columns are available in the table.

- **Well ID** – This column represents the well position in the plate layout.
- **Sample/NTC/Control** – This column shows the sample, NTC, or control name with its corresponding icon that identifies the sample or indicates whether the entry is an NTC or control.
- **Reaction mix** – This column contains the icon and the name of the Reaction mix.
- **Target** – This column shows all target names with its corresponding target type. Targets which were selected as wild type or mutant are marked accordingly.
- **Concentration (copies/μl)** – This column shows the concentration assigned to each target.
- **CI (95%)** – This column shows the value of the confidence interval at a 95% confidence level.
- **Mutation fraction** – This column shows the **Mutant fraction value in %**
- **CI (95%)** – This column shows the value of the confidence interval for mutant fraction at a 95% confidence level.

Sample	Reaction Mix	Target	IC	Type	Concentration (copies/mL)	CI (95%)	Mutant fraction	CI (95%)
A3: Patient 101	Reaction Mix 1	Mutant	-	WT	15.3	10.9%	0.92%	19%
		Wildtype	-	WT	16408	1.1%	-	-
B1: Patient 101	Reaction Mix 1	Mutant	-	WT	16.7	10.8%	1.12%	19%
		Wildtype	-	WT	16403	1.1%	-	-

Replicates are treated different for multiplex and simplex test setup:

- Multiplex test (configured wildtype and mutant targets are part of the same reaction mix):
Replicates are analyzed as separate wells but in addition the mean concentration and mean mutant fraction values together with the corresponding mean CI are provided on demand.

On the right side above the table there is checkbox which allows the user to show mean values for replicates in addition. By default, the button is unchecked, and results are displayed without mean values. When the button is checked the list view still shows independent rows for each selected well, but replicates are grouped together. Replicates from the same group are next to each other in the list view. The list view is extended by 4 columns indicating following mean values:

- Mean concentration value
- CI (95%) – CI of mean concentration as percentage
- Mean mutation fraction as percentage
- CI (95%) – CI of mean mutation fraction as percentage

- Simplex test (configured wildtype and mutant targets are part of different reaction mixes):
For tests having the configured targets in different wells/reaction mixes, the mean result is calculated and shown for replicates in the selection. The list view is extended by 4 columns indicating following mean values:

- Mean concentration value
- CI (95%) – CI of mean concentration as percentage
- Mean mutation fraction as percentage
- CI (95%) – CI of mean mutation fraction as percentage

The replicate results are shown in one row per replicate group. Individual replicate results are not available. The checkbox that allows the user to show mean values for replicates is checked and disabled.

To export the list view information as .csv file, click **Export to CSV**.

Heatmap tab for mutation detection

The Heatmap tab contains a heatmap that shows the mutant fraction as percentage in each of the wells. If a well is not selected as a source for the analysis, the value is not displayed on the heatmap and its background color is gray.

To view an additional toolbar that enables actions related to the diagram, such as downloading the plot, hold the pointer over the diagram. For more details about the toolbar, refer to section Diagram options.

To view detailed information about a well, point the cursor over the well. A tooltip with detailed information opens.

To view the mean values for replicates in multiplex tests, click **Show mean values for replicates**. For simplex tests the mean values view is always shown for replicates and cannot be disabled.

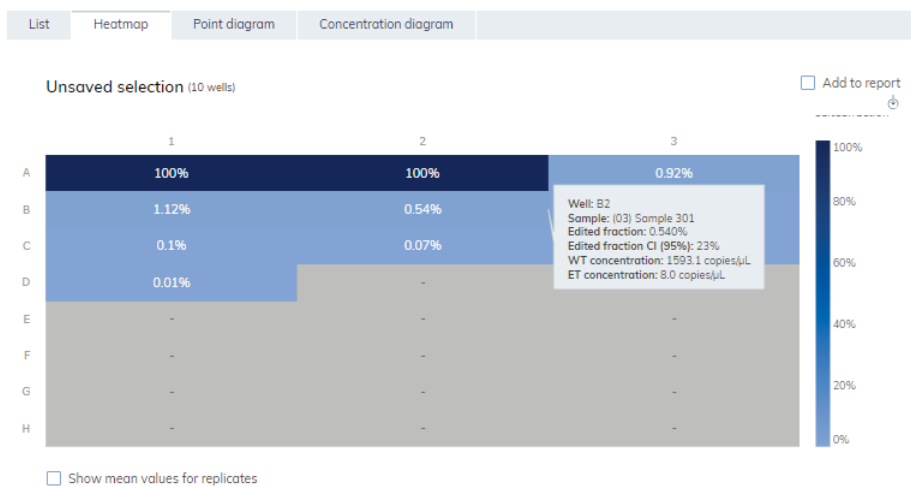

To add the heatmap diagram to the report, click **Add to report**. For more information on reports, see section Reports.

Point diagram tab for mutation detection

The Point diagram tab shows a diagram that displays the percentage of mutant fractions in each analyzed well. A point diagram has two axes. The x-axis shows the analyzed wells and samples, and the y-axis represents the mutant fraction, shown as a percentage.

To view an additional toolbar that enables actions related to the diagram, such as downloading the plot, hold the pointer over the diagram. For more details about the toolbar, refer to section Diagram options.

The y-axis scale can be modified from linear to logarithmic scale using the buttons located on the left below the diagram. The buttons are visible when you hold the pointer over a graph. To view the values on a linear scale, click **lin**. To view the values on a logarithmic scale, click **log10**.

Each combination of wild type target and mutant target in one sample throughout the selected wells is represented in the diagram with one point showing the concentration value together with the confidence interval. To view detailed information, hold the mouse pointer over its corresponding point. A tooltip with detailed information opens.

To view the mean values for replicates for multiplex test, click Show mean values for replicates. If the user clicks into the checkbox to select the mean representation for replicates, the points of individual replicates disappear and only one point is shown at the sample label that represents the mean mutant fraction value of the replicates. When there are no replicates within selected wells for mutant target the points don't change. The corresponding well IDs of the replicates are shown on the x-axis. This is also applied in same way by default to the view where targets are in different reaction mixes. In this case individual replicate results are not available. Mean values are calculated and shown over all replicates that are included in the well selection only. If there are further replicates of the same sample which are not included in well selection, they are not considered in the calculated mean value and show their individual results values.

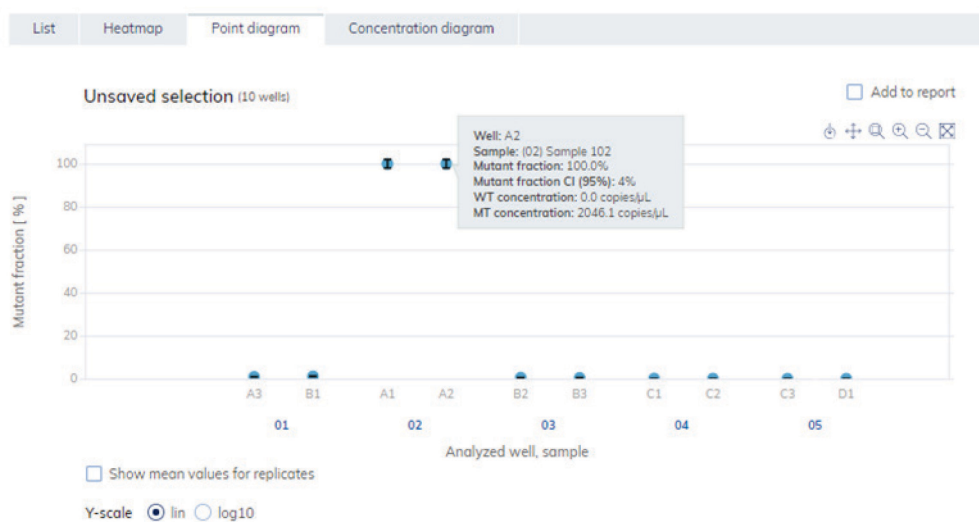

To add the point diagram to the report, click **Add to report**. For more information about reports, see section Reports.

Concentration diagram for mutation detection

The Concentration diagram tab shows a diagram that displays the distribution of concentration values in the wells together with their confidence intervals. A concentration diagram has two axes. The x-axis shows the analyzed wells and samples, and the y-axis represents the concentration values. The y-axis scale can be modified using the buttons located on the left below each graph. The buttons are visible when you hold the pointer over a graph. To view the values on a linear scale, click **lin**. To view the values on a logarithmic scale, click **log10**.

To view an additional toolbar that enables actions related to the diagram, such as downloading the plot, hold the pointer over the diagram. For more details about the toolbar, refer to section Diagram options.

Each combination of wild type target and mutant target in one sample throughout the selected wells is represented in the diagram with one bar showing the concentration value together with the confidence interval. To view detailed information, hold the mouse pointer over its corresponding bar. A tooltip with detailed information opens.

To view the mean values for replicates on the concentration diagram, click Show mean values for replicates. If the user clicks into the checkbox to select the mean representation for replicates, the bars of individual replicates disappear and only one bar is shown at the sample label that represents the mean mutant fraction value of the replicates. When there are no replicates within selected wells for mutant target the bars don't change. The corresponding well IDs of the replicates are shown on the x-axis. This is also applied in same way by default to the view where targets are in different reaction mixes. In this case individual replicate results are not available. Mean values are calculated and shown over all replicates that are included in the well selection only. If there are further replicates of the same sample which are not included in well selection, they are not considered in the calculated mean value and show their individual results values.

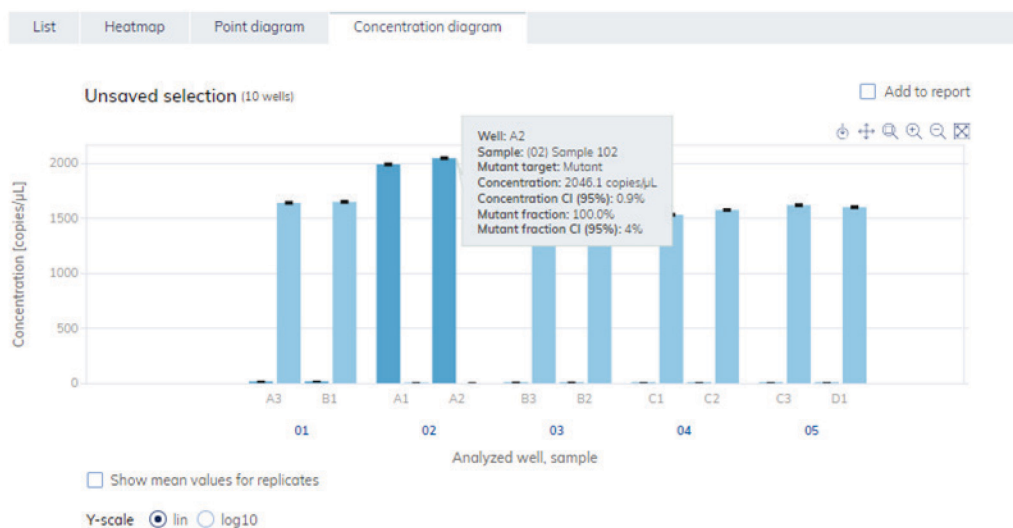

To add the concentration diagram to the report, click **Add to report**. For more information about reports, see section Reports.

6.7.12 Genome editing

The Genome editing tab contains views which provide insight into the number of edited genomes in analyzed wells. The analysis results are put into list views, heatmaps, point diagrams, and concentration diagrams

Note: Saving genome editing tests is not yet provided Setting up a genome editing analysis

1. Click the applicable wells in the plate layout. For more information, see Selecting wells for analysis.

Select source of genome editing analysis (3 wells)

Select imaging step

1 2

Wild type target*

Select target from the list

Edited target*

Select target from the list

Show results

Select all Unselect all Group as hyperwell Ungroup hyperwell

2. Select the applicable wild-type target from the **Wild type target** list.
3. Select the applicable edited target from the **Edited target** list.
4. To view the results of the analysis, click **Show results**.
5. The results are divided into several tabs. To view the contents of the tab, click the tab title.

List tab for genome editing

The List tab contains a table with an overview of the analyzed wells. The following columns are available in the table:

- **Well ID** – This column represents the well position in the plate layout.
- **Sample/NTC/Control** – This column shows the sample, NTC, or control name with its corresponding icon that identifies the sample or indicates whether the entry is an NTC or control.
- **Reaction mix** – This column contains the icon and the name of the well.
- **Target** – This column shows all target names with its corresponding target type. Targets that were selected as wild type or edit type are marked accordingly.
- **Concentration (copies/ul)** – This column shows the concentration assigned to each target or channel.
- **CI (95%)** – This column shows the value of the confidence interval at a 95% confidence level.
- **Edited fraction** – This column shows the edited fraction for the edited target as percentage.
- **CI (95%)** – This column shows the value of the confidence interval for the edited target at a 95% confidence level.

Home Heatmap Point diagram Concentration diagram

Show mean values for replicates

Sample/PC/Control	Reaction Mix	Target	C	Type	Concentration (mean)	Q (95%)	Edited Fraction	Q (95%)
K1 Sample 022	Reaction Mix 1	Wildtype	-	WT	23912	1%	100%	4%
		Wildtype	-	WT	15940	274.4%	-	-
K2 Sample 022	Reaction Mix 1	Wildtype	-	WT	20461	0.9%	100%	4%
		Wildtype	-	WT	58	-	-	-
K3 Sample 011	Reaction Mix 1	Wildtype	-	WT	152	22.7%	100%	10%
		Wildtype	-	WT	16418	1.1%	-	-
K4 Sample 011	Reaction Mix 1	Wildtype	-	WT	167	10.9%	100%	10%
		Wildtype	-	WT	16463	1.1%	-	-

Replicates are treated different for multiplex and simplex test setup:

- Multiplex test (configured wildtype and edited targets are part of the same reaction mix):**
 Replicates are analyzed as separate wells but in addition the mean concentration and mean edited fraction values together with the corresponding mean CI are provided on demand.
 On the right side above the table there is checkbox, which allows the user to show mean values for replicates in addition. By default, the button is unchecked, and results are displayed without mean values. When the button is checked the list view still shows independent rows for each selected well, but replicates are grouped together. Replicates from the same group are next to each other in the list view. The list view is extended by 4 columns indicating following mean values:

 - Mean concentration value
 - CI (95%) – CI of mean concentration as percentage
 - Mean edited fraction as percentage
 - CI (95%) – CI of mean edited fraction as percentage
- Simplex test (configured wildtype and edited targets are part of different reaction mixes):**
 For tests having the configured targets in different wells/reaction mixes, the mean result is calculated and shown for replicates in the selection. The list view is extended by 4 columns indicating following mean values:

 - Mean concentration value
 - CI (95%) – CI of mean concentration as percentage
 - Mean edited fraction as percentage
 - CI (95%) – CI of mean edited fraction as percentage

The replicate results are shown in one row per replicate group. Individual replicate results are not available. The checkbox that allows the user to show mean values for replicates is checked and disabled. To export the list view information as a .csv file, click **Export to CSV**.

Heatmap tab for genome editing

The **Heatmap** tab contains heatmaps that show the edited fraction as percentage in each of the wells. If a well is not selected as a source for the analysis, the value is not displayed on the heatmap and its background color is gray.

To view an additional toolbar that enables actions related to the diagram, such as downloading the plot, hold the pointer over the diagram. For more details about the toolbar, refer to Diagram options.

To view detailed information about a particular well, point the cursor over the well. A tooltip with detailed information opens.

To view the mean values for replicates in multiplex test, click **Show mean values for replicates**. For simplex tests the mean values view is always shown for replicates and cannot be disabled.

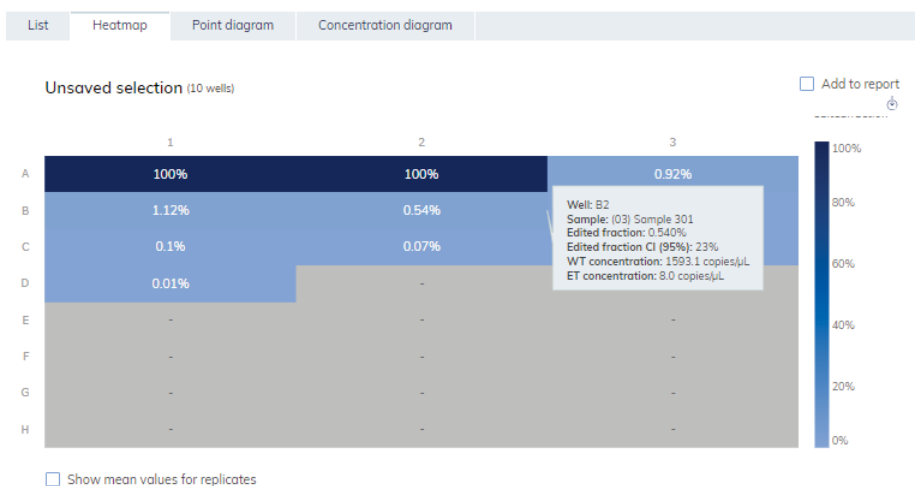

To add the heatmap to the report, click **Add to report**. For more information on reports, see section Reports.

Point diagram tab for genome editing

The Point diagram tab shows a diagram that displays the percentage of edited fractions in each analyzed well. A point diagram has two axes. The x-axis shows the analyzed wells and samples, and the y-axis represents the edited fraction, shown as a percentage.

To view an additional toolbar that enables actions related to the diagram, such as downloading the plot, hold the pointer over the diagram. For more details about the toolbar, refer to section Diagram options.

The y-axis scale can be modified using the buttons located below each graph. The buttons are visible when you hold the pointer over a graph. To view the values on a linear scale, click lin. To view the values on a logarithmic scale, click **log10**.

Each combination of wild type target and edited target in one sample throughout the selected wells is represented in the diagram with one point showing the concentration value together with the confidence interval. To view detailed information, hold the mouse pointer over its corresponding point. A tooltip with detailed information opens.

To view the mean values for replicates, click Show mean values for replicates. If the user clicks into the checkbox to select the mean representation for replicates, the points of individual replicates disappear and only one point is shown at the sample label that represents the mean edited fraction value of the replicates. When there are no replicates within selected wells for edited target the points don't change. The corresponding well IDs of the replicates are shown on the x-axis. This is also applied in same way by default to the view where targets are in different reaction mixes. In this case individual replicate results are not available. Mean values are calculated and shown over all replicates that are included in the well selection only. If there are further replicates of the same sample which are not included in well selection, they are not considered in the calculated mean value and show their individual results values.

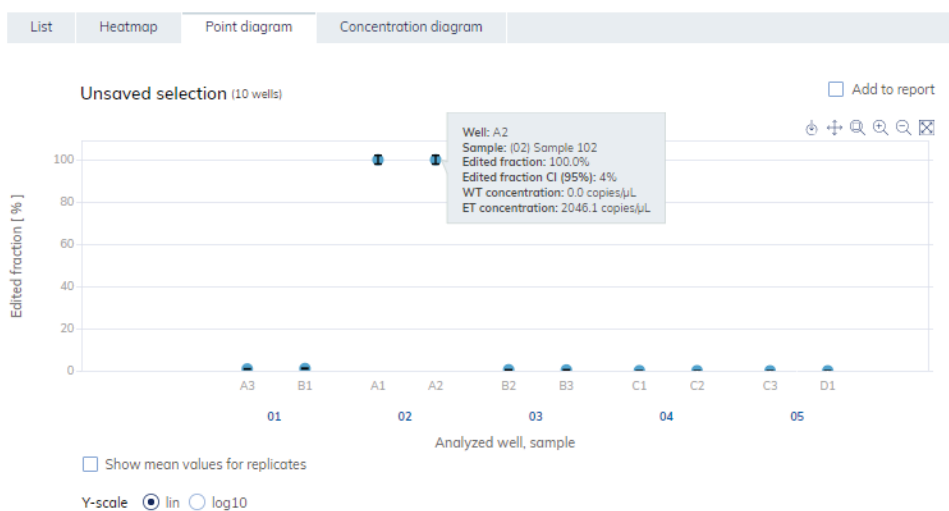

To add the point diagram to the report, click **Add to report**. For more information on reports, see section Reports.

Concentration diagram tab for genome editing

The Concentration diagram tab shows a diagram that displays the distribution of concentration values in the wells together with their confidence intervals. A concentration diagram has two axes. The x-axis shows the analyzed wells and samples, and the y-axis represents the concentration values. The y-axis scale can be modified using the buttons located below each graph. The buttons are visible when you hold the pointer over a graph. To view the values on a linear scale, click **lin**. To view the values on a logarithmic scale, click **log10**.

To view an additional toolbar that enables actions related to the diagram, such as downloading the plot, hold the pointer over the diagram. For more details about the toolbar, refer to Diagram options.

Each combination of wild type target and edited target in one sample throughout the selected wells is represented in the diagram with one bar showing the concentration value together with the confidence interval. To view detailed information, hold the mouse pointer over its corresponding bar. A tooltip with detailed information opens.

To view the mean values for replicates on the concentration diagram, click Show mean values for replicates. If the user clicks into the checkbox to select the mean representation for replicates, the bars of individual replicates disappear and only one bar is shown at the sample label that represents the mean edited fraction value of the replicates. When there are no replicates within selected wells for edited target the bars don't change. The corresponding well IDs of the replicates are shown on the x-axis. This is also applied in same way by default to the view where targets are in different reaction mixes. In this case individual replicate results are not available. Mean values are calculated and shown over all replicates that are included in the well selection only. If there are further replicates of the same sample that are not included in the well selection, they are not considered in the calculated mean value and show their individual results values.

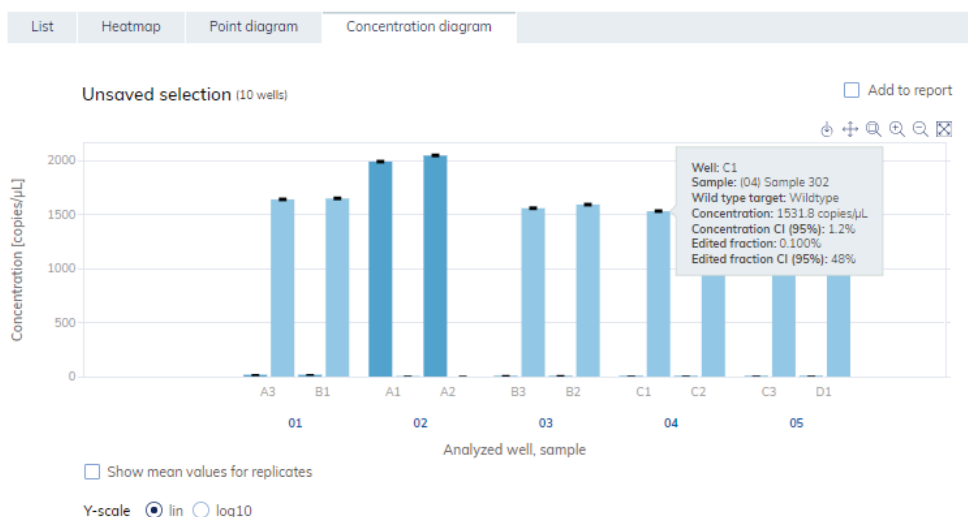

To add the Concentration diagram to the report, click **Add to report**. For more information on reports, see section Reports.

6.7.13 Copy number variation

The Copy number variation tab contains diagrams that visualize the data related to copied genes in targets of interest comparing to reference targets or reference sample. The analysis results are put into list views, heatmaps, point diagrams, and concentration diagrams.

Setting up a copy number variation analysis with reference target

1. Click the applicable wells in the plate layout. For more information, see section Selecting wells for analysis.

Select source of copy number variation (3 wells)

	1	2	3	4	5	6	7	8	9	10	11	12
A	01	01	01	01	01	01	01	01	01	01	01	01
B	02	02	02	02	02	02	02	02	02	02	02	02
C	01	01	01	02	02	02	03	03	03	04	04	
D	01	01	01	02	02	02	03	03	03	04		
E	C	C	C	C	C	C	C	C	C			
F	C	C	C	C	C	C	C	C	C			
G	NTC	NTC	NTC	NTC	NTC	NTC	NTC	NTC	NTC	NTC	NTC	NTC
H	C	C	C	C	C	C	C	C	C	C	C	C

Select all Unselect all Group as hyperwell Ungroup hyperwell

Select imaging step

1 2

CNV with reference target allows checking how the copy number/genome of a particular target of interest varies from one sample to another in relation to the reference target present in the selected samples. The copy number per genome of the reference target is considered to remain constant among all samples to be analyzed.

Reference target * Copies/genome *

Select one reference target 1-99 ⓘ

Target(s) of interest *

Select at least one target of interest ⓘ

Show results

2. Select the applicable reference target from the **Reference target** list.

Select imaging step

1 2

CNV with reference target allows checking how the copy number/genome of a particular target of interest varies from one sample to another in relation to the reference target present in the selected samples. The copy number per genome of the reference target is considered to remain constant among all samples to be analyzed.

Reference target * Copies/genome *

Select one reference target 1-99 ⓘ

Target(s) of interest *

Select at least one target of interest ⓘ

Show results

3. Enter the number of copies per genome in the **Copies/genome** field for the target of interest in reference sample. The value should be between 1 and 99.

4. Select the applicable target that you want to investigate from the **Target of interest** list.

5. Select one or more reference targets from the **Reference target(s)** list.

Note: You can select more than one reference target.

6. To view the results of the analysis, click **Show results**.

7. The results are divided into several tabs. To view the contents of the tab, click the tab title.

Setting up a copy number variation analysis with reference sample

1. Click the applicable wells in the plate layout. For more information, see section Selecting wells for analysis.

Absolute Quantification Mutation Detection Genome Editing **Copy Number Variation** Gene Expression

Select source of copy number variation (2 wells)

Select imaging step

1 2

CNV with reference sample CNV with reference target

CNV with reference sample allows checking how the copy number/genome of a target of interest varies from one sample to another in relation to the reference sample with a known copy number/genome for that particular target(s) of interest.

Reference sample * Copies/genome *

Select sample from the list

Target of interest *

Select reference sample first

Reference selection *

Select reference sample first

Reference target(s) *

Select reference sample first

Show results

2. Select the applicable reference sample from the **Reference sample** list.

Select imaging step



CNV with reference sample

CNV with reference target

CNV with reference sample allows checking how the copy number/genome of a target of interest varies from one sample to another in relation to the reference sample with a known copy number/genome for that particular target(s) of interest.

Reference sample *

Select sample from the list

Copies/genome *



Target of interest *

Select reference sample first



Reference selection *

Select reference sample first



Reference target(s) *

Select reference sample first



Show results

3. Enter the number of copies per genome in the **Copies/genome** field for the target of interest in reference sample. The value should be between 1 and 99.
4. Select the applicable target that you want to investigate from the **Target of interest** list.
5. Select one or more reference targets from the **Reference target(s)** list.
Note: You can select more than one reference target.
6. To view the results of the analysis, click **Show results**.
7. The results are divided into several tabs. To view the contents of the tab, click the tab title.

List tab for copy number variation

The List tab contains a table with an overview of the analyzed wells. The following columns are available in the table:

- **Well ID** – This column represents the well position in the plate layout.
- **Sample/NTC/Control** – This column shows the sample, NTC, or control name with its corresponding icon that identifies the sample or indicates whether the entry is an NTC or control. Reference samples are marked with the word **Ref**.
- **Reaction mix** – This column contains the icon and the name of the Reaction mix
- **Target** – This column shows all target names with its corresponding target type. Note: Targets that were selected as target of interest (TOI) or reference target (Ref) are marked accordingly depending if you selected CNV with reference target or sample.
- **Concentration (copies/μl)** – This column shows the concentration assigned to each target or channel.
- **CI (95%)** – This column shows the value of the confidence interval at a 95% confidence level.
- **Copies/genome** – This column shows the number of copies per genome in each of the targets of interest.
- **CI (95%)** – This column shows the value of the confidence interval for the target of interest at a 95% confidence level.

Sample/NTC/Control	Ref	Reaction Mix	Target	IC	Type	Concentration (copies/μl)	CI (95%)	Copies/genome (copies/genome)	CI (95%)
A1 Sample1	Ref	RM1	m	-	TOI	502.2	2.0%	5.00	0%
			n	-	REF	0.000	0%	n.a.	-
			o	-	-	0.000	0%	n.a.	-
			p	-	-	0.000	0%	n.a.	-
			t	-	-	0.486	62.0%	n.a.	-
B1 Sample2		RM1	m	-	TOI	9.322	14.1%	n.a.	-
			n	-	REF	0.000	0%	n.a.	-
			o	-	-	0.000	0%	n.a.	-
			p	-	-	0.000	0%	n.a.	-
			t	-	-	0.000	0%	n.a.	-

List view for CNV with reference sample.

Sample/NTC/Control	Reaction Mix	Target	IC	Type	Concentration (copies/μl)	CI (95%)	Copies/genome (copies/genome)	CI (95%)
A1 Sample1	RM1	m	-	TOI	0.000	0%	n.a.	-
		n	-	REF	502.2	2.0%	5.00	-
		o	-	-	0.000	0%	n.a.	-
		p	-	-	0.000	0%	n.a.	-
		t	-	-	0.486	62.0%	n.a.	-
B1 Sample2	RM1	m	-	TOI	0.000	0%	n.a.	-
		n	-	REF	9.322	14.1%	5.00	-
		o	-	-	0.000	0%	n.a.	-
		p	-	-	0.000	0%	n.a.	-
		t	-	-	0.000	0%	n.a.	-

List view for CNV with reference target.

Replicates are treated different for multiplex and simplex test setup:

- Multiplex test (configured target of interest and reference targets are part of the same reaction mix):
On the right side above the table there is checkbox which allows the user to show mean values for replicates in addition. By default, the button is unchecked, and results are displayed without mean values. When the button is checked the list view still shows independent rows for each selected well, but replicates are grouped together. Replicates from the same group are next to each other in the list view. The list view is extended by 4 columns indicating following mean values:
 - Mean concentration value
 - CI (95%) – CI of mean concentration as percentage
 - Mean copies/genome
 - CI (95%) – CI of mean mutation fraction as percentage
- Simplex test (configured target of interest and reference targets are part of different reaction mixes):
For tests having the configured targets in different wells/reaction mixes, the mean result is calculated and shown for replicates in the selection. The list view is extended by 4 columns indicating following mean values:
 - Mean concentration value
 - CI (95%) – CI of mean concentration as percentage
 - Mean copies/genome
 - CI (95%) – CI of mean mutation fraction as percentage

Note: If the selected analysis source contains replicates of the reference sample, your results can be calculated only by using mean results for replicates. In this case the “Show mean values for replicates” check box is marked and can’t be changed. In this case there is a warning message above the table and when the user hover on the checkbox, a tooltip appears to inform the user that selected analysis source contains replicates of the reference sample and result is calculated only by using mean results for replicates.

Note: When creating a report for this plate, the result list is automatically included in the report as soon as at least one dedicated diagram for copy number variation (heatmap, point diagram, Concentration diagram) is selected to be included. For more information on reports see section Reports.

To export the results of the list view to an CSV file, click **Export to CSV**.

Heatmap tab for copy number variation

The Heatmap tab contains a heatmap that shows the number of copies per genome in each of the wells. If a well is not selected as a source for the analysis, the value is not displayed on the heatmap and its background color is gray.

To view an additional toolbar that enables actions related to the diagram, such as downloading the plot, hold the pointer over the diagram. For more details about the toolbar, refer to Diagram options.

To view detailed information about a particular well, point the cursor over the well. A tooltip with detailed information opens.

To view the mean values for replicates in multiplex tests, click **Show mean values for replicates**. For simplex tests the mean values view is always shown for replicates and cannot be disabled.

Note: If the selected analysis source contains replicates of the reference sample, your results can be calculated only by using mean results for replicates. In this case the “Show mean values for replicates” checkbox is marked and can’t be changed. When the user hover on the checkbox, a tooltip appears to inform the user that selected analysis source contains replicates of the reference sample and result is calculated only by using mean results for replicates.

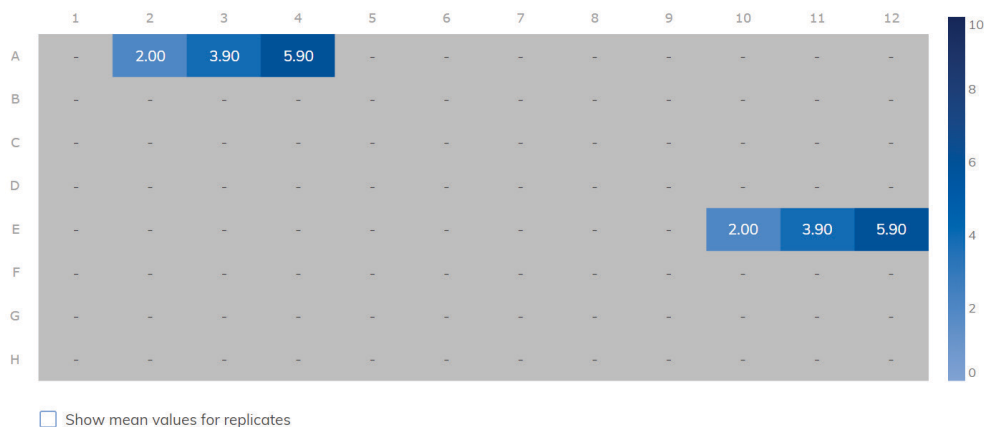

To add the heatmap to the report, click **Add to report**. For more information on reports, see section Reports.

Point diagram tab for copy number variation

The Point diagram tab shows the diagram that displays the number of copies per genome of the configured copy number variation test and the confidence intervals related to every value. A point diagram has two axes. The x-axis shows the analyzed wells and samples, and the y-axis represents the number of copies in each genome. A confidence interval displayed as an error bar is shown for each of the points on the diagram.

To view an additional toolbar that enables actions related to the diagram, such as downloading the plot, hold the pointer over the diagram. For more details about the toolbar, refer to Diagram options.

The y-axis scale can be modified using the buttons located below each graph. The buttons are visible when you hold the pointer over a graph. To view the values on a linear scale, click **lin**. To view the values on a logarithmic scale, click **log10**.

The diagram shows the values as points with the CI as interval for the selected samples. In case that targets are in the same reaction mix, each sample is represented by 1 point. The point color reflects the color assigned to the corresponding target of interest.

The samples are sorted by sample ID but the reference sample of a test is always shown. The well IDs and sample IDs are labeled on the x-axis.

In case that targets are in different reaction mixes each combination of target of interest and reference targets in one sample throughout the selected wells is shown in the diagram with a point for the result. To view detailed information, hold the mouse pointer over its corresponding point. A tooltip with detailed information opens.

To view the mean values for replicates, click Show mean values for replicates. If the user clicks into the checkbox to select the mean representation for replicates, the points of individual replicates disappear and only one point is shown at the sample label that represents the mean copies per genome value of the replicates. When there are no replicates within selected wells the points don't change. The corresponding well IDs of the replicates are shown on the x-axis. This is also applied in same way by default to the view where targets are in different reaction mixes. In this case individual replicate results are not available. Mean values are calculated and shown over all replicates that are included in the well selection only. If there are further replicates of the same sample which are not included in well selection, they are not considered in the calculated mean value and show their individual results values.

Note: If the selected analysis source contains replicates of the reference sample, your results can be calculated only by using mean results for replicates. In this case the “Show mean values for replicates” check box is marked and can't be changed. In this case there is a warning message above the diagram title and when the user hover on the checkbox, a tooltip appears to inform the user that selected analysis source contains replicates of the reference sample and result is calculated only by using mean results for replicates.

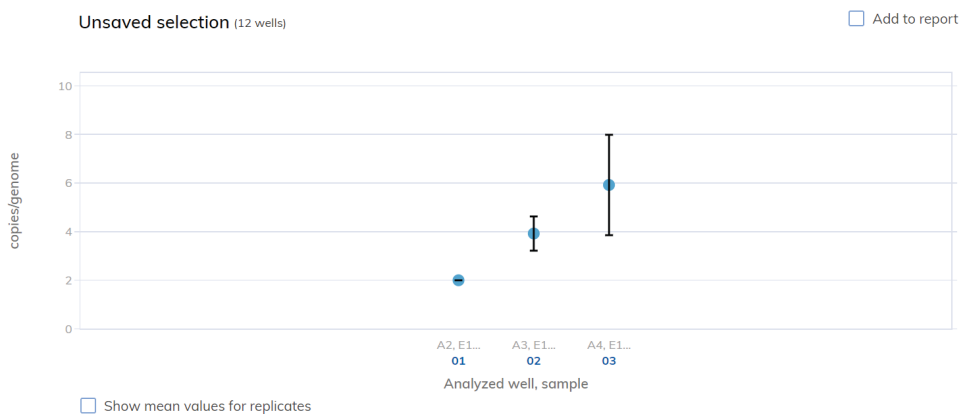

To add the point diagram to the report, click **Add to report**. For more information on reports, see section Reports.

Concentration diagram tab for copy number variation

The concentration diagram tab shows the diagram that displays the concentration values of the configured copy number variation test and the confidence intervals related to every value. A concentration diagram has two axes.

- x-axis represents labels of wells and samples that it belongs to
- y-axis represents the concentration values for selected targets or channels for each well. A confidence interval displayed as an error bar is shown for each of the bars on the diagram.

The y-axis scale can be modified using the buttons located below each graph. The buttons are visible when you hold the pointer over a graph. To view the values on a linear scale, click **lin**. To view the values on a logarithmic scale, click **log10**.

To view an additional toolbar that enables actions related to the diagram, such as downloading the plot, hold the pointer over the diagram. For more details about the toolbar, refer to Diagram options.

The Concentration diagram is a bar plot which presents two values:

- Concentration value as bar
- CI value as error bar

The diagram consists of all possible combinations. Each sample on the diagram is represented by the number of bars according to targets that was selected as a target of interest and reference targets. Samples on the diagram are sorted by the sample ID. Target bars in the sample show one concentration bar for target of interest at first position and concentration bars for reference targets sorted by their well id. The bar color reflects the color assigned to the corresponding targets. The sample ID is shown center-aligned below the bars.

The Bar size is fixed if:

- The reference targets and target of interests are situated on one well there is one well label for all that belongs to the same well.
- The reference targets and target of interests are situated on two wells or more wells there are one well label per targets that are within this well.

When hovering over a bar in the diagram, a tooltip appears presenting details about the actual values of concentration and CI and results of tests.

To view the mean values for replicates on the diagram, click Show mean values for replicates. When this checkbox is checked, the concentration diagram shows bars that represents mean concentration value for replicates within the well selection. The label below the bar shows well positions that are included in the replicates value of mean concentration. On hover on the bar, there is a tooltip with details about wells, sample and target that are part of replicate group and the results are shown as mean result

values with a corresponding mean-label. This is also applied in same way by default to the view where targets are in different reaction mixes. In this case individual replicate results are not available. When selected well has no replicates within all selected wells, individual result values are shown.

Note: If the selected analysis source contains replicates of the reference sample, your results can be calculated only by using mean results for replicates. In this case the “Show mean values for replicates” check box is marked and can’t be changed. In this case there is a warning message above the diagram title and when the user hover on the checkbox, a tooltip appears to inform the user that selected analysis source contains replicates of the reference sample and result is calculated only by using mean results for replicates.

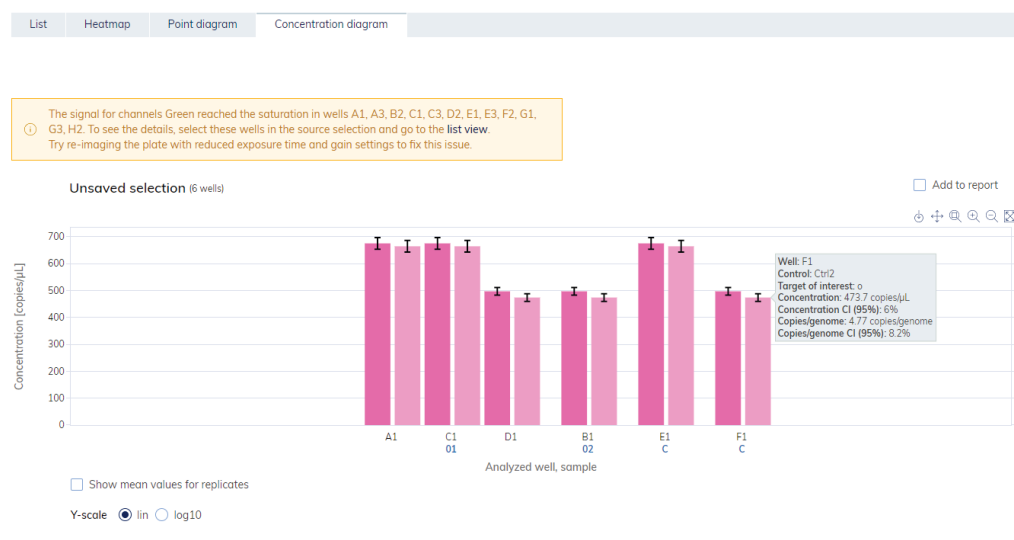

To add the Concentration diagram to the report, click **Add to report**. For more information on reports, see section Reports.

6.7.14 Gene expression

The Software Suite analyzes the gene expression of the samples. The analysis results are put into list views, heatmaps, point diagrams, and concentration diagrams

Note: Saving gene expression tests is not yet provided.

Setting up a gene expression analysis

1. Click the applicable wells in the plate layout.

2. Select the applicable reference sample from the **Reference sample** list.
3. Select the applicable target from the **Target of interest** list.
4. Select one or more reference targets from the **Reference target(s)** list.
5. To view the results of the analysis, click **Show results**.
6. The results are divided into several tabs. To view the contents of the tab, click the tab title.

List tab for gene expression

The list tab contains a table with an overview of the analyzed wells. The following columns are available in the table:

- **Well ID** – This column represents the well position in the plate layout.
- **Sample/NTC/Control Name** – This column shows the sample, NTC, or control name with its corresponding icon that identifies the sample or indicates whether the entry is an NTC or control. Reference samples are marked with the word **Ref**.
- **Reaction mix** – This column contains the icon and the name of the Reaction mix.
- **Target** – This column shows all target names with its corresponding target type. Targets which were selected as target of interest (TOI) or reference target (Ref) are marked accordingly.
- **Concentration (copies/ul)** – This column shows the concentration assigned to each target.
- **CI (95%)** - This column shows the value of the confidence interval at a 95% confidence level.
- **Fold change** – This column shows the change in the level of gene expression in the sample.
- **CI (95%)** – This column shows the value of the confidence interval for the fold change at a 95% confidence interval.
- **Fold regulation** – This column shows the change in the level of gene expression compared to the reference sample.

Add to report Show mean values for replicates [Export to CSV...](#)

Sample/NTC/Control	Ref	Reaction Mix	Target	IC	Type	Concentration (copies/ul)	CI (95%)	Fold change	CI (95%)	Fold regulation
C1 sample_0101	Ref	mixes_1	mutant_A	-	TOI	n.s.	-	n.s.	-	n.s.
			wildtype_1	-	REF	n.s.	-	n.s.	-	n.s.
C1 sample_0102		mixes_1	mutant_A	-	TOI	565.0	8.8%	0.87	10.9%	-1.15
			wildtype_1	-	REF	491.1	9.2%	n.s.	-	n.s.
C2 sample_0102		mixes_1	mutant_A	-	TOI	534.5	8.9%	0.71	9.6%	-1.41
			wildtype_1	-	REF	567.4	8.7%	n.s.	-	n.s.
C3 sample_0102		mixes_1	mutant_A	-	TOI	396.7	10.7%	0.58	11.6%	-1.74
			wildtype_1	-	REF	620.4	9.6%	n.s.	-	n.s.

Replicates are treated different for multiplex and simplex test setup:

- Multiplex test (configured target of interest and reference targets are part of the same reaction mix):
On the right side above the table there is checkbox which allows the user to show mean values for replicates in addition. By default, the button is unchecked, and results are displayed without mean values. When the button is checked the list view still shows independent rows for each selected well, but replicates are grouped together. Replicates from the same group are next to each other in the list view. The list view is extended by 5 columns indicating following mean values:
 - Mean concentration value
 - CI (95%) - CI of mean concentration as percentage

- Mean fold change
 - CI (95%) - CI of mean fold change as percentage
 - Mean fold regulation
- Simplex test (configured target of interest and reference targets are part of different reaction mixes):
For tests having the configured targets in different wells/reaction mixes, the mean result is calculated and shown for replicates in the selection. The list view is extended by 4 columns indicating following mean values:
 - Mean concentration value
 - CI (95%) – CI of mean concentration as percentage
 - Mean fold change
 - CI (95%) – CI of mean fold change as percentage
 - Mean fold regulation

Note: If the selected analysis source contains replicates of the reference sample, your results can be calculated only by using mean results for replicates. In this case the “Show mean values for replicates” check box is marked and can’t be changed. In this case there is a warning message above the table and when the user hover on the checkbox, a tooltip appears to inform the user that selected analysis source contains replicates of the reference sample and result is calculated only by using mean results for replicates.

To export the results to an CSV file, click **Export to CSV**.

Heatmap for gene expression

The Heatmap tab contains a heatmap view that shows the fold change in each of the wells. If a well is not selected as a source for the analysis, the value is not displayed on the heatmap and its background color is gray. In case that a fold change is not applicable for a well, **n.a.** is shown.

To view an additional toolbar that enables actions related to the diagram, such as downloading the plot, hold the pointer over the diagram. For more details about the toolbar, refer to Diagram options.

To view detailed information about a particular well, point the cursor over the well. A tooltip with detailed information opens.

To view the mean values for replicates in multiplex tests, click **Show mean values for replicates**. For simplex tests the mean values view is always shown for replicates and cannot be disabled

Note: If the selected analysis source contains replicates of the reference sample, your results can be calculated only by using mean results for replicates. In this case the “Show mean values for replicates” checkbox is marked and can’t be changed. When

the user hover on the checkbox, a tooltip appears to inform the user that selected analysis source contains replicates of the reference sample and result is calculated only by using mean results for replicates.

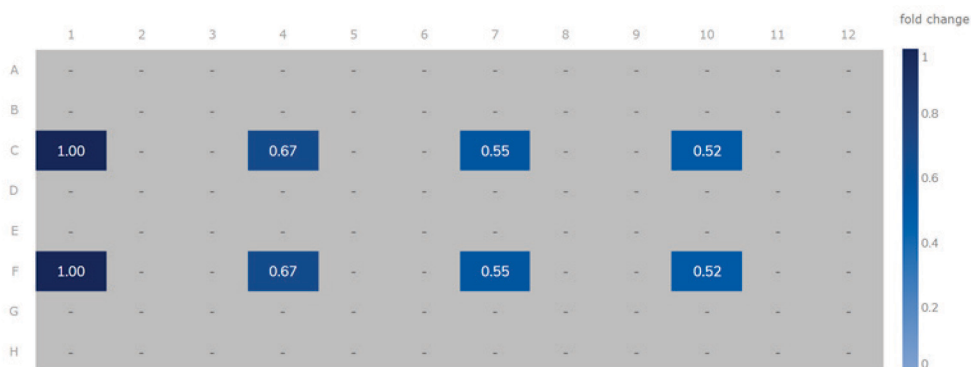

To add the heatmap to the report, click **Add to report**. For more information on reports, see section Reports.

Point diagram for gene expression

The Point diagram tab shows a point diagram view that displays the fold change values of configured gene expression test and the confidence intervals related to every value. A point diagram has two axes. The x-axis shows the analyzed wells and samples, and the y-axis represents the fold change. A confidence interval displayed as an error bar is shown for each of the points on the diagram.

To view an additional toolbar that enables actions related to the diagram, such as downloading the plot, hold the pointer over the diagram. For more details about the toolbar, refer to Diagram options.

The y-axis scale can be modified using the buttons located below each graph. The buttons are visible when you hold the pointer over a graph. To view the values on a linear scale, click **lin**. To view the values on a logarithmic scale, click **log10**.

The diagram shows the values as points with the CI as interval for the selected samples. In case that the targets are in the same reaction mix, each sample is represented by 1 point. The point color reflects the color assigned to the corresponding target of interest.

The samples are sorted by sample ID but the reference sample of a test is always shown first. The well IDs and sample IDs are labeled on the x-axis.

In case that targets are in different reaction mixes each combination of target of interest and reference targets in one sample throughout the selected wells is shown in the diagram with a point for the result. To view detailed information, hold the mouse pointer over its corresponding point. A tooltip with detailed information opens.

To view the mean values for replicates, click Show mean values for replicates. If the user clicks into the checkbox to select the mean representation for replicates, the points of individual replicates disappear and only one point is shown at the sample label that represents the mean fold change value of the replicates. When there are no replicates within selected wells the points don't change. The corresponding well IDs of the replicates are shown on the x-axis. This is also applied in same way by default to the view where targets are in different reaction mixes. In this case individual replicate results are not available. Mean values are calculated and shown over all replicates that are included in the well selection only. If there are further replicates of the same sample which are not included in well selection, they are not considered in the calculated mean value and show their individual results values.

Note: If the selected analysis source contains replicates of the reference sample, your results can be calculated only by using mean results for replicates. In this case the “Show mean values for replicates” check box is marked and can't be changed. In this case there is a warning message above the diagram title and when the user hover on the checkbox, a tooltip appears to inform the user that selected analysis source contains replicates of the reference sample and result is calculated only by using mean results for replicates.

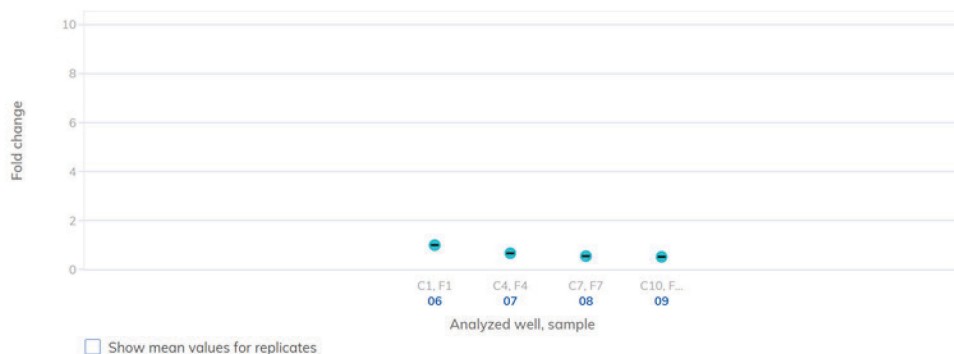

To add any of the point diagrams to the report, click **Add to report** next to the corresponding diagram. For more information on reports, see section Reports.

Concentration diagram for gene expression

The concentration diagram tab shows the diagram that displays the concentration values of the configured gene expression test and the confidence intervals related to every value. A concentration diagram has two axes.

- x-axis represents labels of wells and samples that it belongs to
- y-axis represents the concentration values for selected targets or channels for each well. A confidence interval displayed as an error bar is shown for each of the bars on the diagram.

The y-axis scale can be modified using the buttons located below each graph. The buttons are visible when you hold the pointer over a graph. To view the values on a linear scale, click **lin**. To view the values on a logarithmic scale, click **log10**.

To view an additional toolbar that enables actions related to the diagram, such as downloading the plot, hold the pointer over the diagram. For more details about the toolbar, refer to Diagram options.

The Concentration diagram is a bar plot which presents two values:

- Concentration value as bar
- CI value as bar

The diagram consists of all possible combinations. Each sample on the diagram is represented by the number of bars according to targets that was selected as a target of interest and reference targets. Samples on the diagram are sorted by the sample ID. Target bars in the sample show one concentration bar for target of interest at first position and concentration bars for reference targets sorted by their well id. The bar color reflects the color assigned to the corresponding targets. The sample ID is shown center-aligned below the bars.

The bar size is fixed if:

- The reference targets and target of interests are situated on one well there is one well label for all that belongs to the same well.
- The reference targets and target of interests are situated on two wells or more wells there are one well label per targets that are within this well.

When hovering over a bar in the diagram, a tooltip appears presenting details about the actual values of concentration and CI and results of tests.

To view the mean values for replicates on the diagram, click Show mean values for replicates. When this checkbox is checked, the concentration diagram shows bars that represents mean concentration value for replicates within the well selection. The label below the bar shows well positions that are included in the replicates value of mean concentration. On hover on the bar, there is a tooltip with details about wells, sample and target that are part of replicate group and the results are shown as mean result values with a corresponding mean-label. This is also applied in same way by default to the view where targets are in different reaction mixes. In this case individual replicate results are not available. When selected well has no replicates within all selected wells, individual result values are shown.

Note: If the selected analysis source contains replicates of the reference sample, your results can be calculated only by using mean results for replicates. In this case the “Show mean values for replicates” check box is marked and can’t be changed. In this case there is a warning message above the diagram title and when the user hover on the checkbox, a tooltip appears to inform the user that selected analysis source contains replicates of the reference sample and result is calculated only by using mean results for replicates.

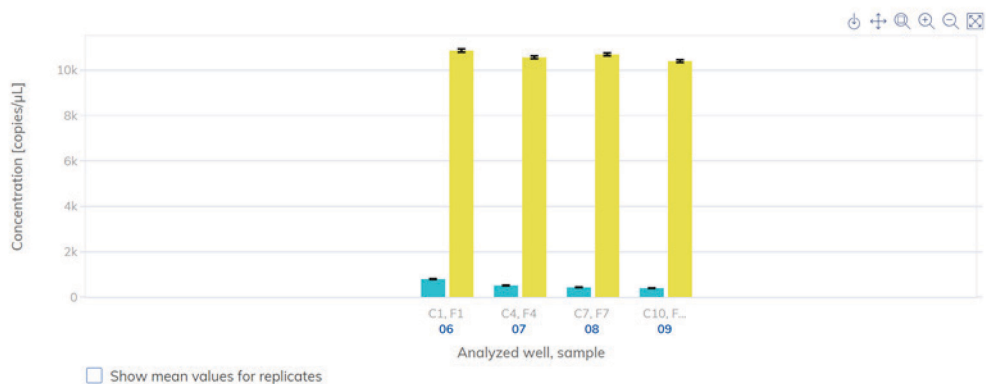

To add the concentration diagram to the report, click **Add to report**. For more information on reports, see section Reports.

6.8 Reports

In the QIAcuity Software Suite, you can create reports about your analysis results of a plate. All created reports remain accessible in the Software Suite and can be downloaded. Only unsigned reports can be deleted.

6.8.1 Creating a new report for a plate from the analysis environment

To create a new report from your analysis results, follow these steps:

1. Enter the Analysis environment of a finished plate. For more information about analyzing a plate, see Analysis.
2. To include a diagram or table of your analysis in your report, check the **Add to report** box of the corresponding diagram you want to include. Checking this box saves and pre-selects the corresponding diagram in the report.
3. To remove the pre-selection of diagram, clear the **Add to report** box.

Note: The total number of pre-selected diagrams for the report is always shown in the footer. The number of diagrams/tables to be included in one report for a plate is limited to 70.

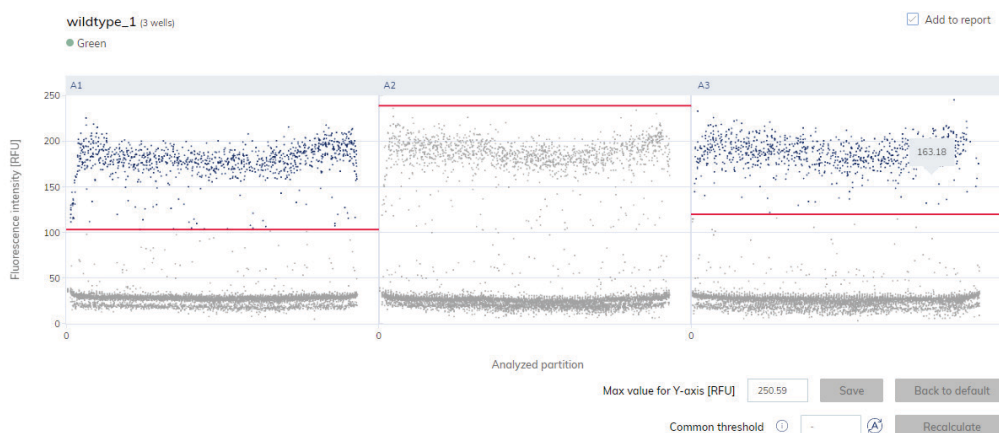





Example of a diagram to be included in a report.

4. Click on the arrow icon  next to the number of selected graphs in the footer to open a preview window of all your preselected diagrams.



Preview window of selected diagrams to be added in the report.

- Use the  icon to delete a diagram from the list of your diagrams to be included in the report. Use the  icon in the preview window or  icon in the footer to close the preview window.

Note: Clicking the  Back to plates icon opens the plates overview screen and preselected diagrams for this plate will be lost.

Important: Once you enter the create report window to perform the next step, going back to the analysis view of the plate loses the list of preselected diagram.

- Click Create report.
- In the Create report dialog box, select which information you want to include in your report. By default, all options are selected.

Note: You can create your own report name and add comment.

Note: You can also select **Diagrams from analysis** to be included in your report. The selected diagrams are displayed as preview.

Below option Diagrams from analysis a preview of your selected diagrams is shown. To include a diagram in the report, ensure that the corresponding checkbox for that diagram is checked.

Note: Before creating the report, you can do a final check of the diagrams that you want to include. Clear the corresponding checkbox of a diagram in the preview to exclude this diagram from the report.

Create Report

Report name * Characters left: 88

Plate report

Select report elements

- Run details
Author, Start and end time, Run steps, Run status, Software & Instrument version
- Plate general data
Plate name, type, description, labels, plate owners, barcode
- Plate layout
List of all the elements added to each well
- Reaction mixes list
List of all your defined reaction mixes with details about each target
- Comments
More information/ details / description about the report Characters left: 256

Create Report view for a plate

8. Use this table as a guide in selecting which information to include in the report.

Table 17. Report elements

Element	Description
Report name	Every Report needs a specific name, without special characters ~ ' " ! @ ^ () = [] { } : ; , < > \ .
Run details	User, Start and end time, Run steps, Run status, Software and Instrument version, dPCR steps
Plate general data	Plate name, type, description, plate owners, labels, barcode
dPCR parameters	Priming profile, Cycling profile (temperature with time duration), Imaging profile (channel, exposure duration, gain)
Plate layout	List of all the elements added to each well
Reaction mixes list	List of all your defined reaction mixes with details about each target
Comments	More information/details/descriptions
Result table	Concentration and error values, partitions
Signers	Users who signed report

Note: The Diagrams or Result tables from analysis option are only available if diagrams are selected to be added to the report.

Note: Clicking the [← Back to analysis](#) icon opens the plate analysis view but the preselected diagrams will be lost!

9. To finish creating the report, click **Generate report PDF**.

10. The report is created and automatically downloaded in the download folder of the PC as a .pdf file. The report is stored in the SW Suite and accessible via the report environment of the plate.

6.8.2 Managing reports of a plate in the report environment

The report environment of a plate provides an overview of all created reports for this plate. You can use this environment to manage your created reports. To enter the report environment of a plate, go to the plate tile in the plates overview. Click the three-dotted icon, then click **Reports**.

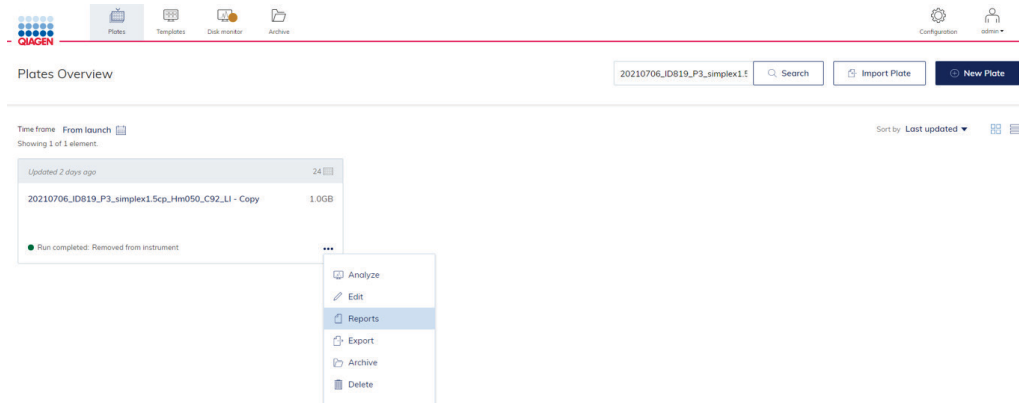



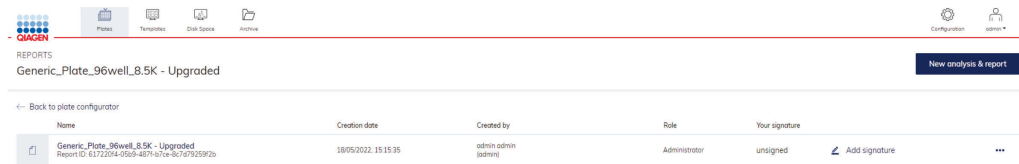

Note: Alternatively, click the plate name in the tile to enter the plate configurator view, then click **Reports** in the context menu.



Use this table as a guide in managing your created reports for a specific plate.

Table 18. Action button in report environment

Action	Description
 Download as PDF	Downloads the report in PDF format
	Delete the report
New analysis & report	Back to Analysis view of this plate
 Back to plates	Back to plates overview screen
 Add signature	Add signature to the report
 Check signers	List signers: user name, role, date, and reason

6.9 Sign report

To support GMP/GLP requirements, the QIAcuity system provides an option to electronically sign existing reports. To do so, the user has to follow the steps given below.

1. Go to report list view.

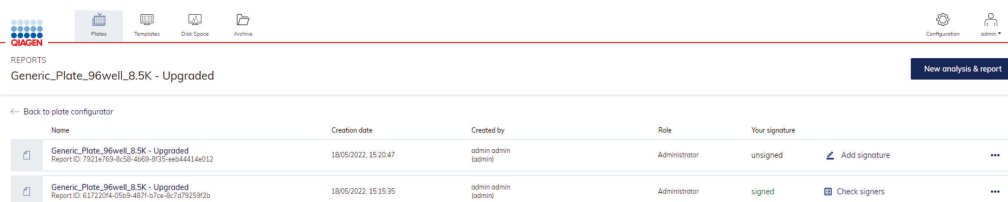

2. Select the **Add signature** button.

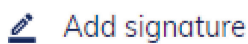

3. A pop-up window will appear with confirmation request. You need to download and read report, then add your password and a reason for signing and finally click **Sign the report** button.

Sign the report

After signing the report removing the signature and signed report will not be possible. The signature will contain your name, surname, role, date and reason for signing. All this information will be added to the report (PDF).

1 Download and read report *

 Download report

2 Add password *

User123! 

Please provide the same password as for login.

3 Add reason of signing *

Characters left: 30

21 CFR part 11 / Internal approval / etc.

4. When the report is signed, an appropriate message will be presented on the report list and the **Add signature** button will be disabled.
5. It is enabled in the system if more than one user can sign the report, but the user cannot overwrite his signature for an already signed report.

 Generic_Plan_36well_8 SK - Upgraded Report ID: 0172084-9508-4071-374e-3c707025992b	18/05/2022, 15:15:35	admin-admin admin	Administrator	signed	 Check signers	...
---	----------------------	----------------------	---------------	--------	---	-----

When the report is signed, a user has an option to check who has performed such action. To do so, please follow the instructions below:

1. Go to report list view.
2. Click on the **Check signers** button.
3. A pop-up window will appear with information about signers.
 - 3a. Name and surname
 - 3b. Login in brackets
 - 3c. Role
 - 3d. Date of signature
 - 3e. Signing reason

Signers

User name (login)	Role	Date	Reason
1. admin admin (admin)	Administrator	05/18/2022	important reason

Close

Moreover, during PDF export of the signed report, an additional page with information about signers (same as the list above) is added at the end of the document: name and surname [login name], role, and date of signature.



Signers

Name of signer	Signer role	Signing date	Reason of signing
1. admin admin (admin)	Administrator	on 18/05/2022	important reason

Sample To Insight

Generated by admin admin (admin) on 18.05.2022 15:20
via QIAcuity Software Suite 2.1.7.351+17954.k@66e8b

6.10 Archive

In the QIAcuity Software Suite, you can set up an archive on an external drive. This will allow you to store your old plates and save disk space on the laptop.

Only the user with Administrator role can set up an archive; to do so, go to Configuration and select the Archive tab:

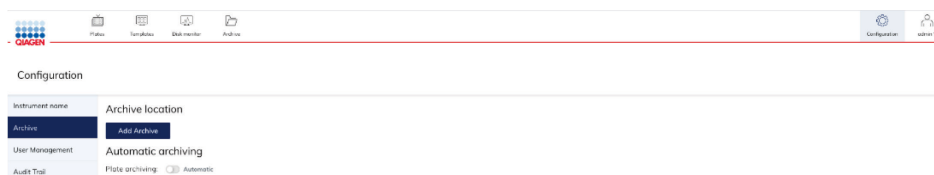

When **Add archive** is clicked, the user can provide a path to the external drive and click **Save**.

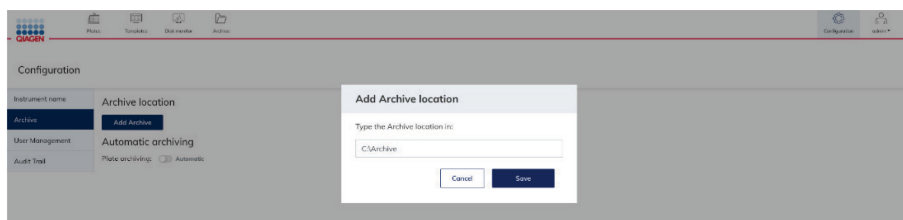

When the archive is configured, suitable information is presented on the Archive configuration screen.

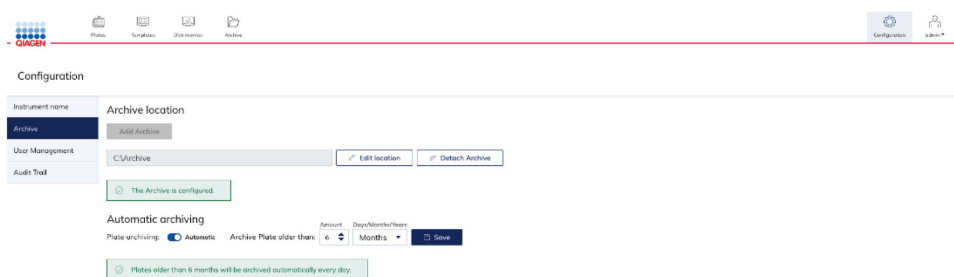

6.10.1 Automatic archiving

When the archive is set up, the administrator can turn on automatic plate archiving. It will automatically move plates older than selected time duration to the archive. The default value is 6 months. When automatic archiving is turned on, suitable information is displayed on the Archive Configuration screen.

Note: Automatic archiving is running at 1 am every day.

6.10.2 Manual plate archiving

When the archive is set up, the user can manually move the plate to the archive. To do so, click the three dots (...) on any of the plates on the Plates Overview screen and select Archive. The plate will be moved to the archive.

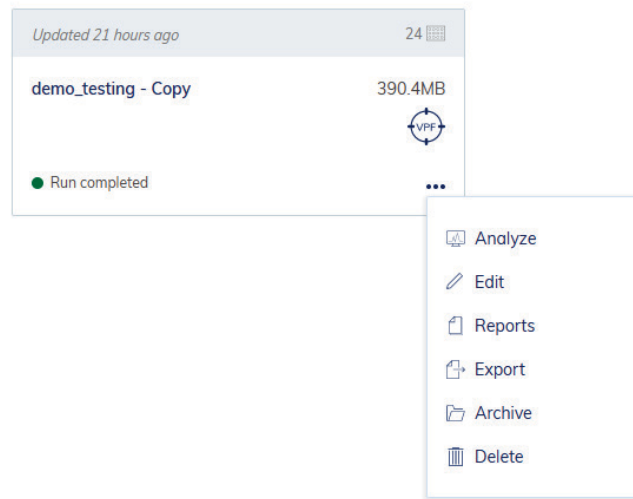

Note: Archiving plates can take a while depending on the speed of data transfer to the external drive.

Note: Due to technical restrictions, there is no possibility to archive plates bigger than 2.5 GB. In that case, communication is presented to the user.



6.10.3 Browsing archive

You can browse and search plates in the archive. Go to **Archive** on the Navigation bar. You can then see all your archived plates.

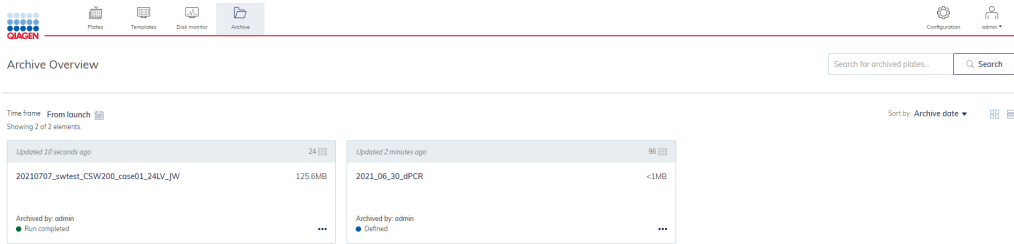

6.10.4 Recovering a plate from the archive

To recover plates from the archive, go to the Archive screen and click on the three dots (...) on any of the plates on the Archive screen and select Restore.

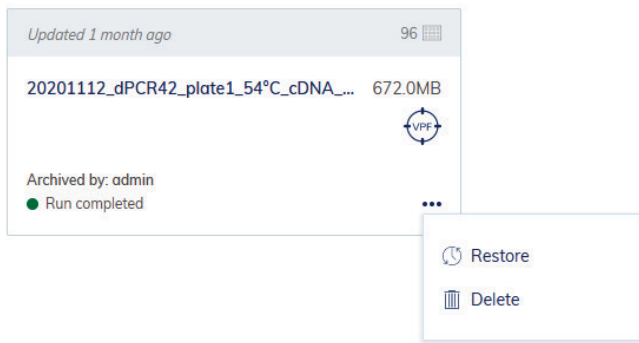

Note: Due to technical restriction, there is no possibility to restore plates bigger than 2.5 GB from the archive.

Note: Restoring plates from the archive can take a while depending on the speed of data transfer from the external drive.

Note: For QIAcuity v2.0 or higher, all imported and restored plates will automatically receive the VPF assignment, if a VPF is loaded in the system.

6.11 Re-analysis of plates after QIAcuity Software Suite version upgrade

After upgrading the QIAcuity Software Suite (see Installation Procedure and Upgrading QIAcuity Software Suite to new version), the status of all plates will be changed to Read-only unless the plates are upgraded to the new software version. The same applies to plates that are imported from a previous Software Suite version.

To upgrade a plate, go to the plate tile in the plates overview and select the upgrade button . Alternatively, click the plate name in the tile to enter the plate configurator view; then, click **Upgrade** in the context menu.

During the plate upgrade, a new Plate will be created as a copy of the old Plate and an animation is shown, indicating the upgrade process. During the upgrade, both plates are blocked and cannot be accessed and changed to avoid inconsistent data or loss of data.

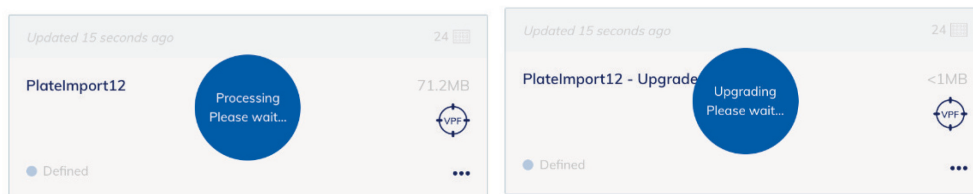

If the Plate has upgraded successfully, two plates will be displayed. The grey marked one with an arrow is the old plate, which includes the previous performed analysis. By clicking on the arrow, the user is automatically re-directed to the upgraded plate, which has the original Plate name attached with "-Upgraded". This upgraded plate was re-analyzed by the upgraded QIAcuity Software Suite version.

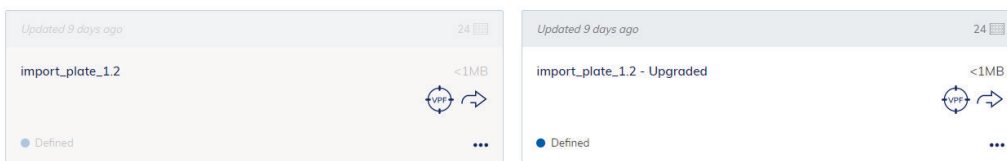

If a plate upgrade fails, the following message is displayed. The not-upgraded plate is not changed and shows the analysis results of the previous Suite version.

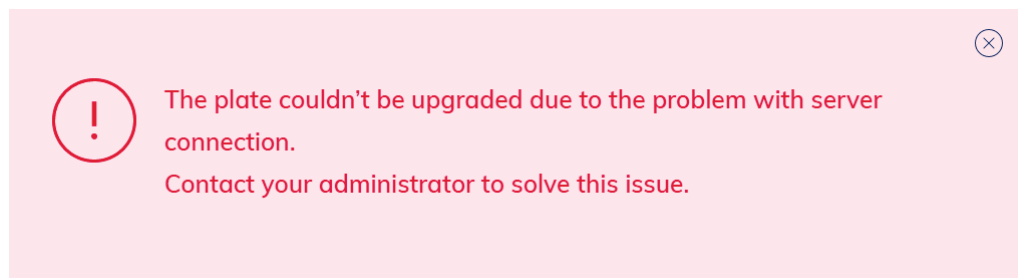

6.12 Volume Precision Factor (VPF)

The volume precision factor (VPF) offers a unique feature to secure consistency in precision of concentration results obtained from a QIAcuity dPCR run. In general, Nanoplates provide partitions of fixed sizes that enable a very precise way of sample concentration calculation. Potential variation of partition sizes in Nanoplate batches, caused by different stampers (molding form for microstructures), can be addressed by applying the stamper-specific VPF. The VPF specifies the exact cycled volume of a well within a Nanoplate and therefore further increases precision of concentration calculation in each well. If a VPF is not available for a Nanoplate batch, concentrations are calculated using an average cycled volume per plate until the VPF is imported. The microstructure molding form is defined by the first two digits of the plate barcode.

Note: Multiple plate batches can come from one microstructure molding form.

New sets of VPFs will be published during production of the Nanoplate batches and can be downloaded from the QIAGEN website.

6.12.1 Identification of plates without VPF

Plates without VPF can be analyzed using an average volume per plate. Such plates are marked with the VPF (target) icon on the Plates Overview screen.

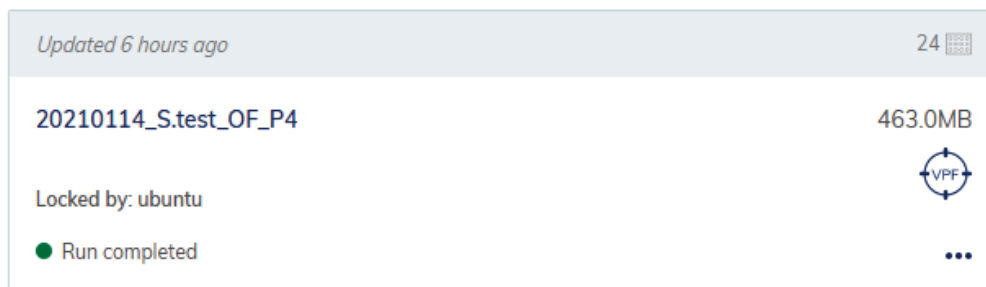

In addition, information about missing VPF is available on the Plates Overview screen, Analysis screen, Plate Configuration screen, and on the Report.

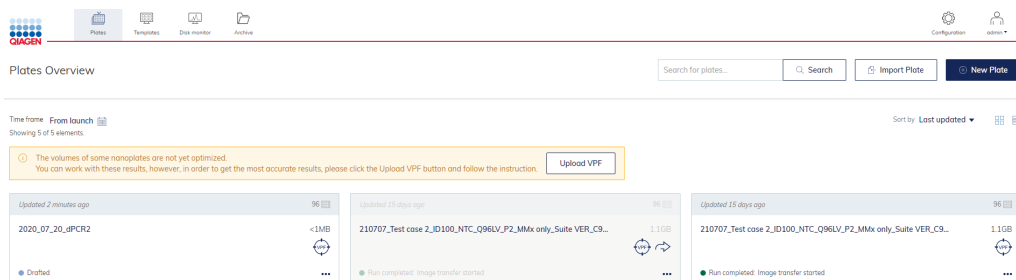

6.12.2 Loading VPF

All existing VPFs to all used microstructure negative forms are bundled together in one zip file to allow the user to always download the most recent version. After uploading the file, the QIAcuity Software Suite automatically chooses which VPFs are missing and applies them. To load the most recent VPF, you can either click on the VPF icon of the plate or directly click on the **Upload VPF** button on the Plates Overview screen, Analysis screen, or on the Plate Configuration screen

Note: New VPFs are valid for the whole system, and once loaded, they will affect all existing Nanoplate experiments for which VPF can be found.

Once clicked, a new pop-up window will show up with detailed instruction:

Upload Volume Precision Factor (VPF) ⓧ

The Volume Precision Factor (VPF) specifies the exact volume of a nanoplate of a specific batch providing most accurate concentration results. If a VPF is not available for a new nanoplate batch, concentrations are calculated using an average volume per plate until the VPF is downloaded.

- 1 Go to <http://resources.qiagen.com/qiacuity-vpf>

or as alternative

Go to www.qiagen.com

Select:

Products > Instruments & Automation > PCR Instruments >

QIacuity Digital PCR System > Product Resources >

Operating Software

- 2 Download VPF file to your desktop or external disk
- 3 Upload the file here



Choose a file or drag it here

Cancel

Save

Please follow the steps to properly load the most recent VPF file.

Note: The structure of the VPF file is a zip file. There is no need to extract it.

When loaded, the QIacuity Software will refresh all plates and align concentrations using the newly loaded well-based volumes. The notifications about missing VPF for applicable plates will no longer be shown.

Note: In QIacuity v2.0 or higher, all imported and restored plates will automatically receive the VPF assignment, if a VPF is loaded in the system.

7 Operating Plates

In the QIAcuity plate-based system, one reaction mix per well is partitioned into a large number of individual partitions prior to the amplification step, resulting in one or very few templates being present in each partition. QIAGEN offers different plate types according to specific user needs.

Table 19. Plate types according to user needs

Plate type	Frame color	No. of wells	Input volume/well (μ l)	No. of partitions	Partition volume (nl)
Nanoplate 26K 24-well	Blue	24	40	Approx. 26000	Approx. 0.82
Nanoplate 26K 8-well	Light blue	8	40	Approx. 26000	Approx. 0.82
Nanoplate 8.5K 24-well	White	24	12	Approx. 8500	Approx. 0.34
Nanoplate 8.5K 96-well	Gray	96	12	Approx. 8500	Approx. 0.34

Please note that the QIAcuity Software Suite calculates with a partition volume of 0.82 nl and 0.34 nl in case the VPF (volume precision factor) has not been applied. If the VPF has been loaded to the software, the volume of each well is Nanoplate batch-specific calibrated and used for concentration calculation. Thus, the concentration calculated by the QIAcuity Software Suite will differ to concentration values calculated manually.



Image of Nanoplate 26K 24-well, Nanoplate 8.5K 24-well, and Nanoplate 8.5K 96-well.

7.1 QIAcuity Nanoplate 26K 24-well

For applications requiring high sensitivity, QIAGEN offers the 26K nanoplate. In this plate, one reaction mix is distributed over 4 wells and separated into approximately 26000 partitions. The plate may be used for up to 24 samples and has a blue frame as distinction from the other plates.

The key applications of the 26K nanoplate are:

- Rare mutation detection
- Liquid biopsy

7.2 QIAcuity Nanoplate 26K 8-well

For applications requiring high sensitivity, QIAGEN offers the 26K nanoplate. In this plate, one reaction mix is distributed over 4 wells and separated into approximately 26000 partitions. The plate may be used for up to 8 samples and has a light blue frame as distinction from the other plates.

The key applications of the 26K nanoplate are:

- Rare mutation detection
- Liquid biopsy

7.3 QIAcuity Nanoplate 8.5K 24-well

In this plate, one reaction mix is distributed in 1 well and separated into approximately 8500 partitions. The plate is recommended for applications using low input volumes and a small number of samples. The plate may be used for up to 24 samples and has a white frame as distinction from the other plates.

The key applications of the 8.5K nanoplate are:

- CNV detection
- NGS library quantification

7.4 QIAcuity Nanoplate 8.5K 96-well

In this plate, one reaction mix is distributed in 1 well and separated into approximately 8500 partitions. This plate is recommended for applications using low input volumes and large number of samples. The plate may be used for up to 96 samples and has a grey frame as distinction from the other plates.

The key applications of this nanoplate are:

- CNV detection
- NGS library quantification

7.4.1 Reaction setup

Note: The QIAcuity reads fluorescence from the bottom of the plate, which is covered with a foil. For best results, keep the foil clean and avoid damages such as scratches. Also, keep the barcode on the side of the plate clean and intact. Ensure that you wear gloves when working with a plate and do not apply force to it.

For better handling of the plate, you can place the plate into the Nanoplate tray that can be ordered as accessory, see Appendix B – QIAcuity Accessories or the QIAcuity webpage on www.qiagen.com

To set up a plate, follow these steps:

1. Prepare your master mix according to your reaction setup. To prepare the reaction mix without sample, the QIAcuity PCR Master Mix has to be mixed with primers, RNase-free water and optionally restrictions enzyme and probes according to the kit manual. The final volume depends on the QIAcuity Nanoplate which is used (refer to Table 19).

Note: To prevent non-homogeneous reaction mixes, the set up in a standard PCR pre-plate is required. The calculated reagent volumes have to be pipetted into the PCR pre-plate, and then the sample has to be added accordingly. For homogenous mixing of reaction mix, the pre-plate has to be sealed, shortly vortexed and briefly centrifuged.

Note: Enzymatic fragmentation of DNA larger than 20 kilobase ensures even distribution of template throughout the QIAcuity Nanoplate, which in turn leads to accurate and precise quantification. Therefore, adding a restriction enzyme depends on the template used. In case of enzymatic fragmentation using the recommended restriction enzymes, the pre-plate has to be incubated at RT for 10 minutes. Longer incubation doesn't lead to unspecific restriction and therefore has no impact on the result. Refer to the Application guide on www.qiagen.com for the recommended restriction enzymes.

Important: Do not pipet master mix and sample separately into the Nanoplate as this will lead to insufficient mixing.

2. Pipet each reaction mix from the pre-plate into a well of the Nanoplate. If possible, use an electric one-channel pipette. To ensure bubble-free pipetting, we recommend to pipette 39 μ l for Nanoplate 26K 8/24-well, and 11 μ l for Nanoplate 8.5K 96/24-well of your prepared reaction mix to the bottom of the respective input well of the Nanoplate. Ensure not to pipet into the output well instead of the input well.

Note: To avoid damaging the optical surface and to reduce dust that will interfere with the imaging and analysis of results, we recommend to place the Nanoplate into a Nanoplate tray before pipetting the reaction mix into the Nanoplate.

Note: Do not centrifuge the Nanoplate as this will lead to pre-priming and insufficient filling of the wells.

Note: Do not vortex the Nanoplate as this will lead insufficient filling of the wells.

3. Apply the plate seal that comes with the Nanoplates as follows to ensure good filling of the wells and to prevent evaporation and contamination:
4. The stiff plate seal consists of a plate seal and 2 protective foils. The 3 layered foil should not be folded. Remove the bottom white protective foil carefully, center and align the plate seal (still containing the upper protective foil) with the lower edge of the colored frame of row H. The foil should not overlap on any side more than 1 mm, otherwise the Nanoplate might not be processed by the instrument. In case the plate seal is incorrectly placed or the seal does not cover some parts of the

Nanoplate, carefully remove this seal and repeat sealing step with a new one. Correct sealing of the Nanoplate prevents samples from not being fully processed.

Note: It is recommended to cover the plate within 30 minutes after pipetting with the top seal to prevent subsequent filling issues.

Note: Please keep the plate seals stored in a dry, darkened, and air-sealed environment,

5. After correct placing, the plate seal has to be fixed with the Nanoplate roller in the horizontal and vertical direction.
6. Afterwards, the upper protective foil is removed on the bottom left corner. We recommend that one finger holds the rubber foil on the plate corner in place while the upper transparent foil is pulled off. If the upper foil would be pulled off in another way, the plate seal might get loose.
7. Use the Nanoplate roller with high force to fix the plate seal on the Nanoplate by rolling at least 3 times forwards and backwards in horizontal, and also 3 times forwards and backwards in the vertical direction over the edge of the plate. Roll over the plate seal covering the Nanoplate frame. The proper fixing of the plate seal is important for a good filling of the wells.

Note: For a properly sealed plate, the plate seal covers the whole structure, and no bubbles or strong depressions are visible, as this can also lead to bad filling of the wells.

8. The plate frame gives the option to mark the plate with a marker pen. Use the lane between the plate edge and the printed letters (next to column 1) as well as the mirrored part (from column 12 to the plate edge) only. Marking the plate seal above the wells is not recommended as it might lead to bad filling of the wells.

Important: Do not mark the bottom side of the plate, as it is used to read fluorescence signals.

Note: Ensure that overlapping parts of the plate seal are turned down and well attached to the plate frame and that the barcode is not covered. Do not apply pressure to the plate seal.

9. For the transport of the Nanoplate to the QIAcuity instrument, the plate should be held at the side edges or on the tray horizontally. Make sure that the plate is transported to the QIAcuity smoothly without shaking or turning of the plate, to ensure, that the reaction mix is at the bottom of the input well.
10. The plate can now be used to start a run. For more information about starting a run on the QIAcuity, see section Operating the QIAcuity Software Suite.

Note: Do not store the plate for more than 2 hours before the start of a run as this may lead to pre-priming of the reaction mix resulting in reduced number of analyzable partitions.

11. If the plate is kept dark avoiding exposure to moving air (e.g., storage in a dark box), you can store the plate after the run for up to 1 week at room temperature or at 4°C. (Note: Storage time may vary due to dye/probe stability, master mix, and previous imaging step/settings). You can re-image a plate up to 6 times (7 total imagings), see Setting up an experiment for more information on how to re-cycle and re-image a plate.

Note: For not properly stored plates, the fluorescence intensity and plate seal integrity can be affected, which could lead to contamination of the laboratory. Please store processed plates according to these guidelines or dispose them properly after the process.

8 Maintenance Procedures

WARNING/ CAUTION 	Risk of personal injury and material damage Only perform maintenance that is specifically described in this user manual.	[W1]
--	--	------

The following maintenance procedures must be carried out to ensure reliable operation of the QIAcuity:

- Regular maintenance
- Periodic maintenance

Optionally, these procedures may be performed to check and ensure the reliability of operation of the QIAcuity.

Select the cleaning agent according to the objective of the cleaning procedure, the sample material used, and the downstream assay.

WARNING 	Risk of fire or explosion When using ethanol or ethanol-based liquids on the QIAcuity, handle such liquids carefully and in accordance with the required safety regulations. If liquid has been spilled, wipe it off and allow flammable vapors to disperse.	[W1]
---	--	------

Before using any cleaning or decontamination methods except those recommended by the manufacturer, users should check with the manufacturer that the proposed method will not damage the equipment.

8.1 Cleaning agents

The following disinfectants and detergents are recommended for cleaning the QIAcuity.

Note: If you want to use disinfectants different from those recommended, ensure that their compositions are similar to those described below.

General cleaning of the QIAcuity:

- Mild Detergents (e.g., Mikrozyd® AF sensitive)
- 25% ethanol

8.1.1 Disinfection

Ethanol-based disinfectants can be used for disinfection of surfaces: e.g., 25 g ethanol and 35 g 1-propanol per 100 g liquid or Mikrozid Liquid (Schülke & Mayr GmbH, cat. no. 109160).

Disinfectants based on glyoxal and quaternary ammonium salt can be used, e.g., 10 g glyoxal, 12 g lauryldimethylbenzylammonium chloride, 12 g myristyldimethylbenzylammonium chloride, and 5–15% nonionic detergent per 100 g liquid, Lysetol® AF (Gigasept Instru AF in Europe, cat. no. 107410, or DECON-QUAT® 100, Veltek Associates, Inc., in the USA, cat. no. DQ100-06-167-01).

Removal of RNase contamination

RnaseZap® RNase Decontamination Solution (Ambion, Inc., cat. no AM9780) can be used for cleaning surfaces. RnaseZap can also be used to perform decontamination by spraying the respective items.

Removal of nucleic acid contamination

DNA-ExitusPlus™ (AppliChem, cat. no. A7089,0100) can be used for cleaning surfaces. DNA-ExitusPlus can also be used to perform decontamination by spraying the respective items. DNA-ExitusPlus is very sticky and foamy. For this reason, after cleaning the items with DNA-ExitusPlus, you must clean the items with a wet cloth several times, or rinse them with running water, until the DNA-ExitusPlus is completely removed.

General instructions

- Do not use spray bottles to spray cleaning or disinfectant liquids onto surfaces of the QIAcuity.
- If solvents or saline, acidic, or alkaline solutions are spilt on the QIAcuity, wipe the spilt liquid away immediately.
- Follow manufacturer's safety instruction for handling cleaning agents.
- Follow manufacturer's instruction for soaking time and concentration of the cleaning agents. **Important:** Immersing for longer than the recommended soak time can harm the instrument.
Note: Disinfection reagents shall be distributed equally on the instrument surface and drops shall be avoided
- Ensure that no liquid runs down the touchscreen. Liquid may be drawn through the dust protection sealing by capillary forces and cause malfunction of the display. To clean the touchscreen, moisten a soft lint-free cloth with water, ethanol, or a mild detergent and carefully wipe the display. Wipe dry with a paper towel.

CAUTION 	Damage to the instrument Do not use bleach, solvents, or reagents containing acids, alkalis, or abrasives to clean QIAcuity.	[C10]
---	--	--------------

CAUTION 	Damage to the instrument [C11] Do not use spray bottles containing alcohol or disinfectant to clean surfaces of the QIAcuity. Take special care while cleaning the extended drawer that no liquid is spilled into the inside of the instrument.
---	--

WARNING 	Risk of fire [W24] Do not allow cleaning fluid or decontamination agents to come into contact with the electrical parts of the QIAcuity. Take special care while cleaning the extended drawer that no liquid is spilled into the inside of the instrument.
---	---

WARNING 	Risk of electric shock [W24] Do not open any panels on the QIAcuity. Risk of personal injury and material damage Only perform maintenance that is specifically described in this user manual.
---	--

WARNING 	Hazardous chemicals and infectious agents [W24] The plates may contain hazardous material and must be disposed of properly. Refer to your local safety regulations for proper disposal procedures.
---	---

WARNING 	Risk of personal injury and material damage [W1] Improper use of the QIAcuity may cause personal injuries or damage to the instrument. The QIAcuity must only be operated by qualified personnel who have been appropriately trained. Servicing of the QIAcuity must only be performed by a QIAGEN Field Service specialist.
---	--

WARNING 	Risk of explosion [W23] When cleaning the QIAcuity with alcohol-based disinfectant, allow flammable vapors to disperse.
---	--

WARNING 	Risk of fire or explosion [W23] When using ethanol or ethanol-based liquids on the QIAcuity, handle such liquids carefully and in accordance with the required safety regulations. If liquid has been spilled, wipe it off and allow flammable vapors to disperse.
---	---

WARNING 	Toxic fumes [W23] Do not use bleach to clean or disinfect the QIAcuity.
---	--

WARNING 	Toxic fumes [W23] Do not use bleach to disinfect used labware.
---	---

8.2 Servicing

Contact QIAGEN Technical Services or your local distributor for more information about flexible Service Support Agreements from QIAGEN.

WARNING 	Risk of personal injury and material damage [W1] Improper use of the QIAcuity may cause personal injuries or damage to the instrument. The QIAcuity must only be operated by qualified personnel who have been appropriately trained. Servicing of the QIAcuity must only be performed by a QIAGEN Field Service specialist.
---	--

8.3 Regular maintenance procedure of QIAcuity

Clean the instrument on a regular basis, especially if fluids have been spilled on the instrument. See Cleaning agents for the recommended cleaning agents you can use to clean the QIAcuity instrument. All outer surfaces of the instrument, including the touch display, and the extended drawer can be cleaned.

8.4 Periodic maintenance

8.4.1 Air filter change

We recommend that you change the air inlet filter of the instrument once per year. This will be part of an annual scheduled service visit. When operating the instrument in unusual dusty environments, a more frequent filter change might be necessary.

Note: Air filters can be ordered separately. See Ordering information for more information.

Follow these steps for changing the air filter:

1. Turn off instrument and remove power cord.
2. Reach under the front of the instrument and push both buttons simultaneously.



3. Remove the filter from the swing-out filter compartment.



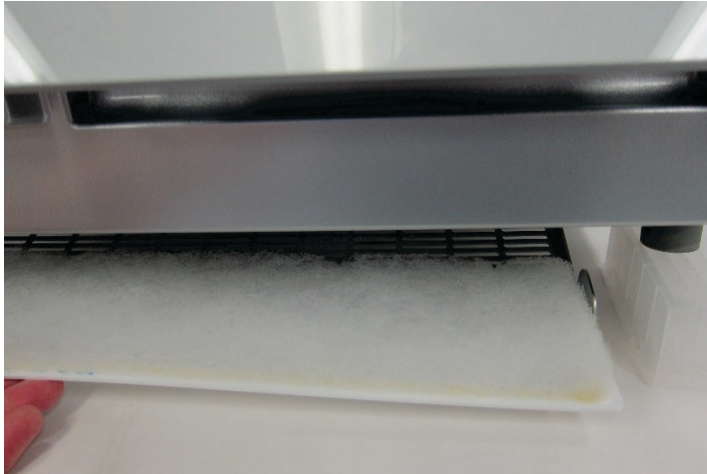

4. Replace with a new filter and push the compartment to the top to close.

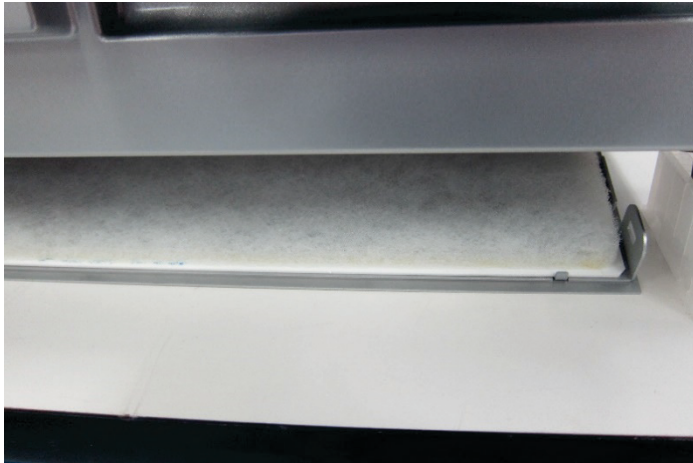

8.4.2 Calibration of thermal cycler

The thermal cycler is designed to operate with the same specifications over the lifetime of the instrument. To ensure and verify the quality of the cycler, the calibration of the thermal cycler is part of an annual scheduled service visit.

8.5 Decontaminating the QIAcuity

If the QIAcuity is contaminated with infectious material, it should be decontaminated. If hazardous material is spilt on the outer surfaces or the plate trays of the QIAcuity, the user is responsible for carrying out appropriate decontamination. If damaged plates were used and the inside of the instrument is contaminated, please contact QIAGEN Technical Services.

The QIAcuity should also be decontaminated before shipping (e.g., back to QIAGEN). In this case, a decontamination certificate must be completed to confirm that the decontamination procedure has been carried out.

To decontaminate the QIAcuity, follow the procedure in section Disinfection, using the recommended disinfection agents.

8.6 Regular maintenance procedure for QIAcuity Instrument Software

The QIAcuity stores various information about the runs and plates used in the instrument. Images created during the runs are deleted automatically after they are transferred to the QIAcuity Software Suite. If the instrument is not connected to the Software Suite, the data is cached on the local storage until a connection to the Software Suite is established. Other plate information is saved on the local storage of the device as temporary data.

8.6.1 Deleting temporary data

You can remove temporary data from the instrument to save space on the local storage or to clear some space on the disk when the disk space becomes full. The current state of available storage is shown in the Storage Info pane and the below Disk Monitor icon (once clicked).

When the disk space is running low, a notification is shown to all users. Operators do not have permission to delete the temporary files, and they are instructed to contact their administrator.

1. Tap the **Tools**  icon.
2. Tap Data Management.

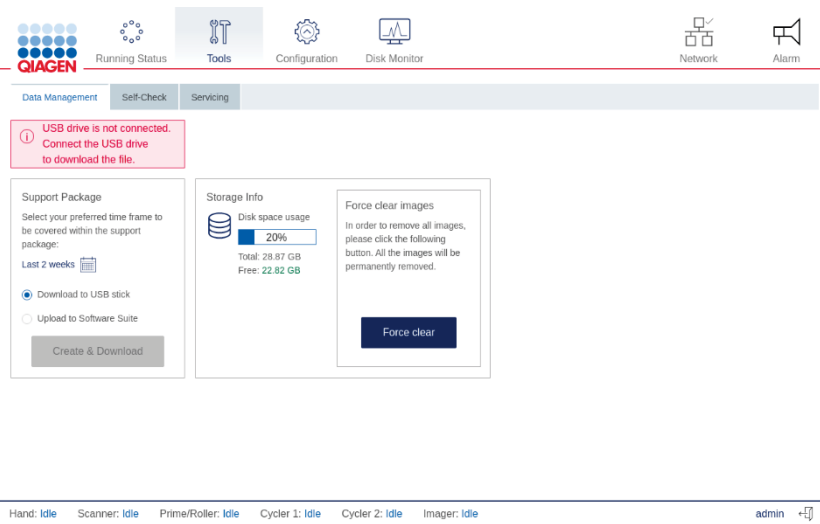

3. To clear the data, tap **Force clear images**. Click **OK** in the confirmation dialog box to delete the data. Images from the system and database will be removed.

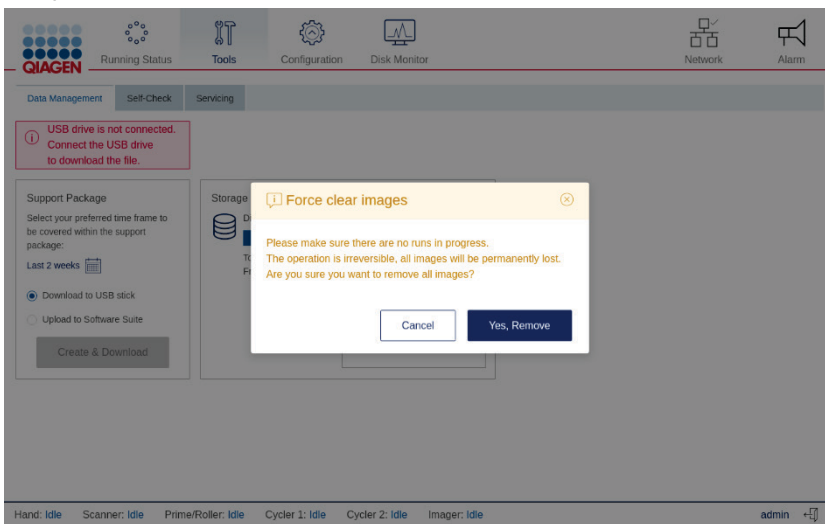

8.7 Regular maintenance procedure for QIAcuity Software Suite

To monitor the space of your disk, click **Disk monitor** in the main toolbar. This shows an overview about the state of the disk, disk name, and disk path. It also shows the remaining free space and total space of your disk.

Disk Space Monitor



Disk monitor overview.

There are four different disk states possible regarding the availability of free space.

Table 20. Disk status

State	Meaning	Flag
Normal	No threshold has been reached	None
Warning	Disk space reached the warning level, there is only disk space for a few runs left	Yellow dot in disk monitor icon
Critical	No disk space left to store more run data	Red dot in disk monitor icon
Unavailable	The disk is not available.	None

To free up disk space, you can export and delete used plates. See *Managing your plates* for more information about exporting and deleting plates.

Note: It is recommended to check the free disk space on a regular manner and to archive or delete data appropriately.

9 Troubleshooting

9.1 General information

This section provides information about what to do if an error occurs while using QIAcuity.

9.2 Contacting QIAGEN Technical Services

Whenever you encounter a QIAcuity error, ensure that you have the following information at hand:

- Software version
- Sample input material
- Detailed description of the error situation
- Serial number of the instrument

This information will help you and your QIAGEN Technical Service Specialist to deal most efficiently with your issue.

Note: For most cases, to allow proper analysis of an error situation, the support package either from the instrument and/or the Suite is required. Refer to [Creating a support package](#).

Note: Information about the latest software and protocol versions can be found at www.qiagen.com/MyQIAcuity. In some cases, updates may be available for addressing specific problems.

9.3 Performing a self-check on the QIAcuity instrument

The QIAcuity software can perform a self-check of the instrument to check the state of the device. There are two types of self-checks:

- **Quick test:** This test does not include any hardware movement
- **Extended test:** This test includes hardware movement. All modules return to their initial positions. If a plate is detected in the gripper, the plate is returned to the drawer.

To start a self-check, follow these steps:

1. Tap **Tools** .
2. Tap **Self-check**.
3. Tap **Quick Test** or **Extended Test** depending on the type of test you want to perform.

4. The instrument starts the test. The ongoing actions and their statuses are shown in the Log File Preview pane. The log from the test can be downloaded as part of a support package. For more information about support package, see [Creating a support package](#).

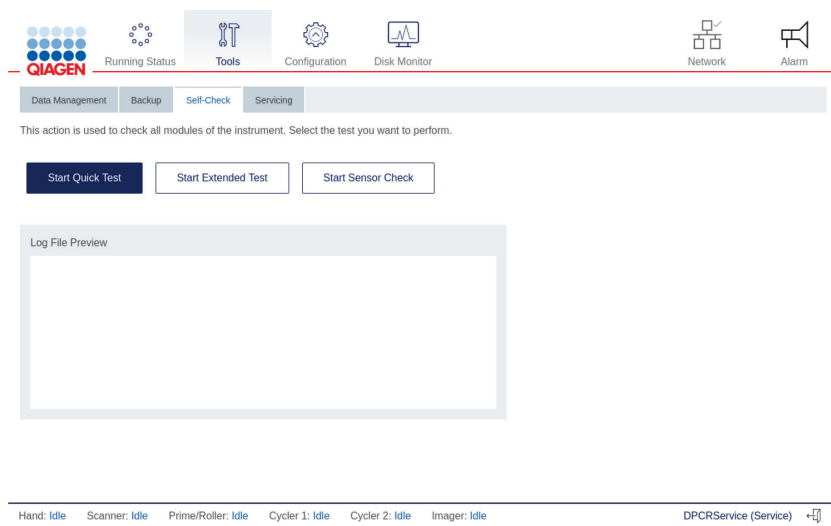



9.4 Creating a support package with the QIAcuity instrument software

You can create a support package in case of an error. The support package can be uploaded to the Software Suite or saved to a USB drive.

To create a support package and upload it to the Software Suite, follow the steps below. The QIAcuity Software Suite will combine the support package from the instrument and the Software Suite.

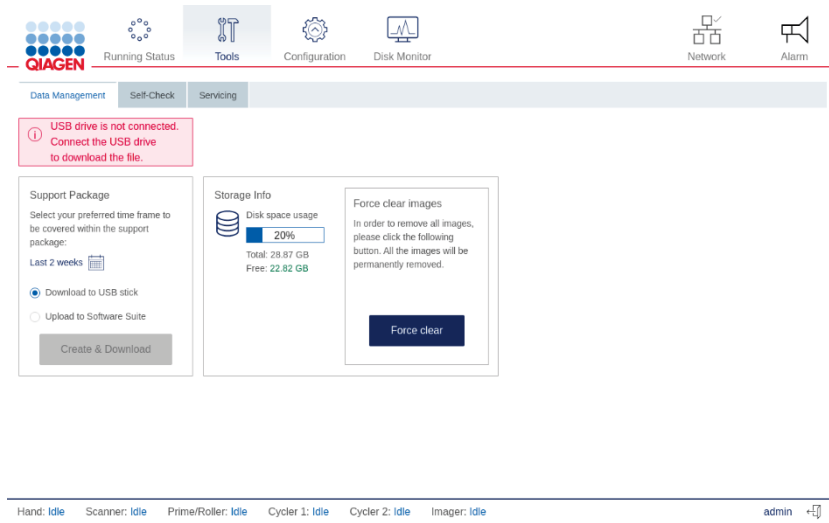
1. On the toolbar, tap **Tools**.
2. Tap **Data Management**.



3. In the Support package pane, select **Upload to Software Suite**.
4. To set the timeframe of the support package, tap **Set timeframe** . The default timeframe is the last two weeks.
5. Tap the applicable option for your preferred timeframe.
 - Tap **Today** to create a support package for the current day.
 - Tap **Last week** or **Last 2 weeks** to select either the last week or the last two weeks.
 - To set a custom timeframe, tap **From** and select a start date from the calendar. Then, tap **To** and select an end date from the calendar.
6. Tap **Apply** to save the changes.

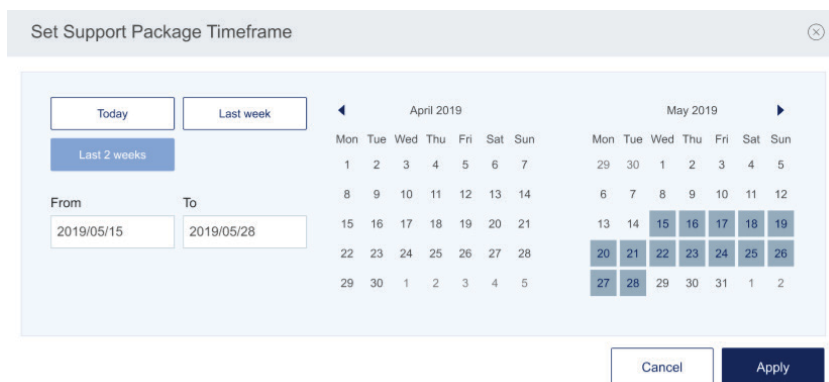

Set Support Package Timeframe dialog box.

7. Tap **Create & Download**.
8. A progress bar is shown. To cancel the download, tap the progress bar. Once the download is complete, a notification is displayed.

To create a support package and save it on a USB drive, follow the steps below.

1. On the toolbar, tap **Tools** .
2. Tap **Data Management**.

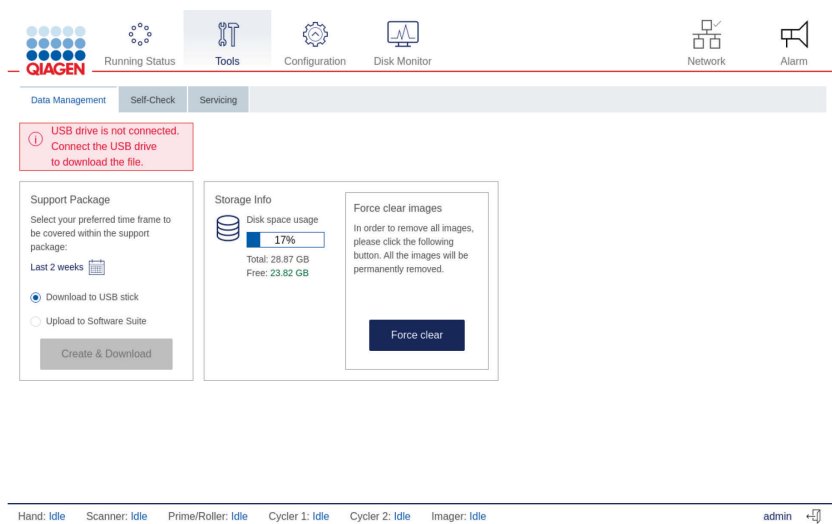

3. Connect a USB drive to the instrument. Wait for the device to detect the USB drive. A notification is displayed once the drive is connected.

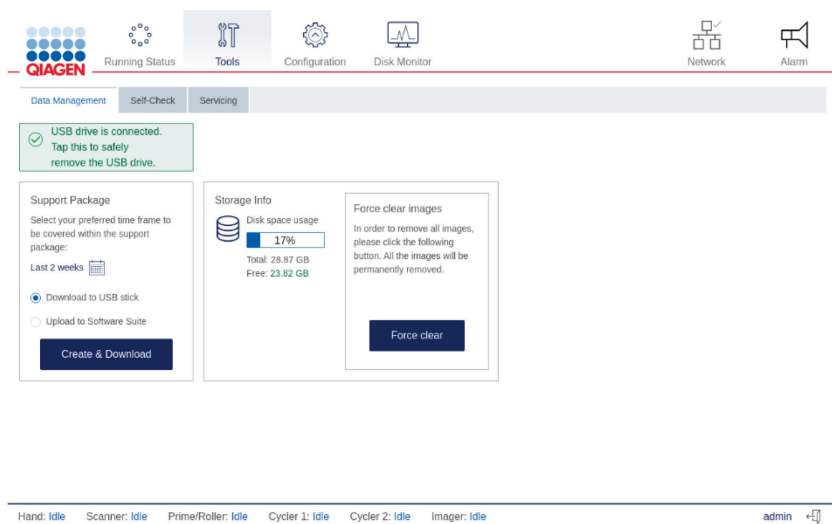

4. In the Support Package pane, Select **Download to USB drive**.
5. To set the timeframe of the support package, tap **Set timeframe** . The default timeframe is the last two weeks.
6. Tap the applicable option for your preferred timeframe.
 - Tap **Today** to create a support package for the current day.

- Tap **Last week** or **Last 2 weeks** to select either the last week or the last two weeks.
- To set a custom timeframe, tap **From** and select a start date from the calendar. Then, tap **To** and select an end date from the calendar.

7. Tap **Apply** to save the changes.

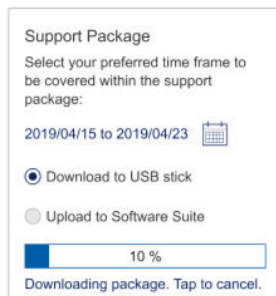
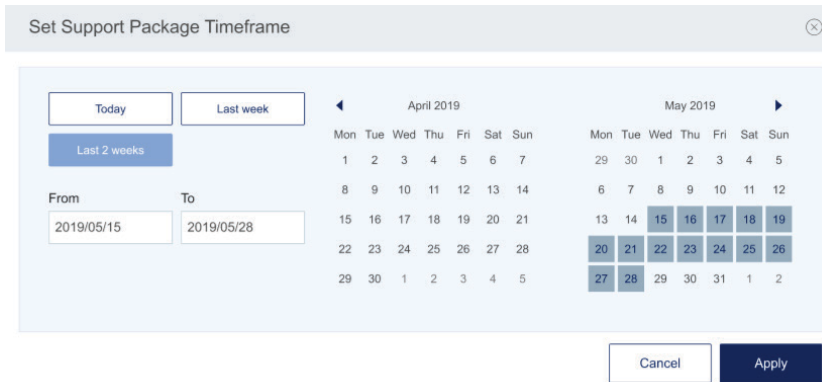

8. Tap Create download.

9. A progress bar is shown. To cancel the download, tap the progress bar. Once the download is complete, a notification is displayed, and the USB drive can be removed from the instrument.

9.5 Creating a support package with the QIAcuity Software Suite

1. Select a plate in the plates overview.
2. Click the left side of the screen on Support Package.

A new window pops up, where you can specify what kind of support package you want to generate and from which time frame.

PLATE CONFIGURATOR
Generic_Plate_96well_8.5K - Upgraded

General Data

dPCR parameters

Reaction mixes

Samples & controls

Plate layout

Analyze

Reports

Export

Support package

Delete

General Data

The volume of this nanoplate is not yet optimized.
You can work with these results, however, in order to get the most accurate results, please click the Upload VPF button and follow the instruction.

Plate name * Characters left: 64
Generic_Plate_96well_8.5K - Upgraded

Plate type
Nanoplate 8.5K 96-well

Description Characters left: 2000

Labels Labels left: 10
Confirm each label with 'Enter' button

Plate Ownership *
admin admin (admin) add user
Type user name, surname or login to add user

Barcode
You may scan it using USB scanner, enter it now or scan it later, by the instrument

PLATE CONFIGURATOR
Generic_Plate_96well_8.5K - Upgraded

General Data

dPCR parameters

Reaction mixes

Samples & controls

Plate layout

Analyze

Reports

Export

Support package

Delete

General Data

The volume of this nanoplate is not yet optimized.
You can work with these results, however, in order to get the most accurate results, please click the Upload VPF button and follow the instruction.

Plate name * Characters left: 64
Generic_Plate_96well_8.5K - Upgraded

Plate type
Nanoplate 8.5K 96-well

Description Characters left: 2000

Labels Labels left: 10
Confirm each label with 'Enter' button

Plate Ownership *
admin admin (admin) add user
Type user name, surname or login to add user

Barcode
You may scan it using USB scanner, enter it now or scan it later, by the instrument

SUPPORT PACKAGE

Plate 1

Support package details

Please select package details:

standard package
combined images and logs

extended package
raw images and logs (> 20 MB)

Select date range: 21.3.2020 - 22.3.2020 

[Download](#)

Note: The standard package includes the log files and a combined image view of all wells. The extended package includes the log files and the raw images of each single well. By clicking on the calendar symbol, you can define the time frame from which the support package shall be generated. Click **Download** to download the support package as zip file.

9.6 Troubleshooting the instrument and software

Comments and suggestions

Installation and maintenance	
a) Instrument doesn't power on	Check if the power outlet is working properly and the correct voltage is applied. Check the correct connection of the power cable between power outlet and instrument power inlet. If the instrument fuses are blown, please contact QIAGEN Technical Services.
b) Handler blocked	If the hand can't move freely during initialization of the instrument, please check if the transport locking screw was removed according to the installation procedure.
c) Overheating	If an overheating error is shown or the instrument shuts off during an operation, please ensure correct ventilation of the instrument and correct environmental conditions according to the installation chapter requirements. Please ensure that the air filter is not clogged and exchanged on a regular basis.
d) The connection between the instrument and the QIAcuity Software Suite is not working after the connection was changed from a direct to a LAN connection or vice versa, or after a network IP reassignment (e.g., via DHCP settings).	The QIAcuity Software Suite requires a new certificate. Open the Control Panel on the Windows PC and search for "Programs and Features". Right click on QIAcuity Software Suite program and choose the Change option. You will see a window, offering three options (Repair, Uninstall, and Cancel). Before starting the repair function, please ensure that the cable is properly connected to a laptop and the Instrument or a network, depending on the selected setup. Click the Repair button and proceed with the instructions. Then, restart the laptop. See section Renew certificate for more details. Note: Do not use the uninstall option as this would delete all existing plate data.
e) A data directory was detected as an "unknown variable postgresqlini" error that occurred during installation	Ambient temperatures of below 17°C (63°F) require an equilibration phase of approx. 30–60 min at the location where the instrument will be used before the instrument is powered on

Plate loading	
a) Plate presence/orientation	The instrument detects the proper orientation of the plate. Please ensure that the barcode is pointed to the instrument back and the microstructures to the bottom.
b) Plate Seal presence	A missing Plate Seal is detected by the instrument. Please ensure that always a closed plate with Plate Seal is loaded into the instrument. A run cannot be started if a plate seal is not detected by the instrument. Only use QIAGEN products for closing the plates.
c) Drawer blocking	If the drawer is retrieved and blocked, please ensure that the plate is correctly loaded into the drawer and parallel to the base surface of the drawer.
d) Plate retrieving	If a plate couldn't be retrieved correctly in the instrument, please ensure that the Plate Seal is applied properly and not overlapping more than 1 mm at the plate side surfaces.
e) Plate barcode cannot be linked to an experiment; or Plate barcode cannot be read	Check for any typo in the plate barcode of the experiment in the QIAcuity Software Suite.
f) Run cannot start	Check if the QIAcuity Software Suite is online.

Mechanical	
a) Frame of instrument is distorted (e.g., uneven, unstable or not level)	Ensure that the instrument is placed on a stable, flat and level surface as described in Installing the QIAcuity.
b) Scratches appear on the instrument	

Electronic	
a) Display does not turn on	Do not touch the display with excessive force or use corrosive chemicals to clean the display surface. Contact QIAGEN Technical Services for repair.

Comments and suggestions

b)	Error when copying files to USB	Power OFF the QIAcuity, wait for a few minutes, and power it ON again. Save the file(s) to the USB stick again. Check the USB stick on a PC to ensure it is functional. If the error persists, contact QIAGEN Technical Services.
c)	USB device not detected	Power OFF the QIAcuity, wait for a few minutes, and power it ON again. Insert the USB stick into the USB port. Check the USB stick on a PC to ensure it is functional. If the error persists, contact QIAGEN Technical Services.
d)	Login screen not visible when starting instrument	If the touchscreen does not display the login screen, but instead a software update message is shown, power OFF the QIAcuity and wait for a few minutes. Ensure that the USB stick is not inserted in the USB port. Power ON the QIAcuity again. The login screen should be visible. If the error persists, contact QIAGEN Technical Services.
e)	Error displayed when inserting the USB stick into a Windows PC	
f)	Starting of instrument takes long	After Update of the instrument software the Firmware Update might be run in the background causing a long starting period. (up to 60 minutes)

Application

a)	Images or analysis data cannot be viewed	Check the connection to the QIAcuity instrument.
b)	Poor or no amplification	Check if the correct protocols and reagents have been used. Check if the reaction was set up correctly. Check the cycling and imaging conditions. Check if correct restriction enzyme was used when using gDNA as template material. Check the starting quality and quantity of the template. We recommend that you use QIAGEN kits for sample preparation.
c)	No clear separation between positive and negative partitions	Check if the correct protocols and reagents have been used. Check if the reaction was set up correctly. Check the cycling and imaging conditions. Check if correct restriction enzyme was used when using gDNA as template material. Check the starting quality and quantity of the template. We recommend that you use QIAGEN kits for sample preparation.
d)	Images are saturated	Re-image the plate with 30% lower exposure duration (see also section Image quality control)
e)	Sample result is 0 copies/ μ l or infinite in absolute quantification	If your concentration is 0 copies/ μ l, although the sample is not an NTC, check the Histogram or 1D Scatterplot for this well. In case you have nearly only positive partitions in the well, a proper auto-threshold setting was likely not possible. Please check also if the image of the well is too dark, and in case re-image the plate with 30% higher exposure time or gain settings.
f)	Sample results of replicates differ a lot	Check the images for blacked-out areas, that can occur, e.g., due to bad filling or areas of low amplification (see section Image corrective measures)
g)	High copy number in NTC	Check the images or signal map for dust or other particles. In case, wipe the plate with a lint-free tissue (optionally, use ethanol) and re-image the plate.
h)	Lower RFU of negative partitions in NTC/samples with low number of positive partitions	The signal intensity might be lower in images with high number of negative partitions. There's no influence on the result analysis, as the signal to noise is not affected.
i)	The confidence interval is wide	The number of valid partitions is low. Check the images for blacked-out areas, that can occur, e.g., due to bad filling or areas of low amplification (see section Image corrective measures)
j)	Vertical stripes in the images	Please re-image the plate for proper image analysis
k)	Double positive or double negative signals	The double positive or double negative signals could have different root causes. One of the reasons for observing double signal bands could be suboptimal assay designs, such as cross-hybridization of probes to unspecific targets or secondary off-target amplification products. Besides assays-related causes, improper crosstalk compensation could also be the root cause. An insufficient compensation or overcompensation of crosstalk from neighboring channels could also result in extra signal bands. To determine the main root cause, re-image the plate with 30% less exposure times for affected channel. If double bands disappear or get much closer to each other after re-imaging, they are most likely to be caused by improper crosstalk compensation rather than assay-related issues.

Comments and suggestions

- | | | |
|----|---|--|
| l) | Fetch error while accessing the Users list in User Management | If such error occurs, please contact QIAGEN Technical Service in order to solve the issue. |
|----|---|--|

Software

- | | | |
|----|--|---|
| a) | The QIAcuity Software Suite does not start | Check that the software is installed on the laptop. Check the operating system. The QIAcuity Software Suite can only be operated and Windows 10. |
| b) | Installation of QIAcuity Software Suite failed | Check the firewall settings on Windows and router to make sure that the following ports: 8080, 8687, 9595, 44321 are available and opened in the network. |
| c) | Disc space is critical in the QIAcuity Software Suite | Delete plates from the plates overview. |
| d) | User forgot password | Administrator to log-in, change the password for the user. If administrator forgot the password, contact QIAGEN Technical Service. |
| e) | Communication error between QIAcuity instrument and software | This error occurs when the data received from the instrument does not conform to the expected pattern. Further investigations are required by a QIAGEN Field Service Specialist to diagnose the problem with the instrument.
Please contact your distributor or QIAGEN Technical Service. |
| f) | Instrument software or Software Suite is unresponsive | Re-start the QIAcuity instrument or the notebook where the QIAcuity Software Suite is installed |
| g) | Startup of instruments displays an error | The required plate recovery task cannot be performed because there are no plate slots available in the tray. Remove all loaded plates before you proceed. Press Restart to start recovery. |
| h) | Error 205 or Error 32 | The error can occur in different situations:
A) Please make sure that the selected Plate type corresponds with the entered barcode, if manually entered. If not matching, it will lead to an error on the instrument (error 205).
B) Please make sure that after the first successful suite connection, the instrument is restarted to allow automatic synchronization of labware files. |
| i) | Error 490 | The error can occur after a plate was processed and a failure in image transfer to the Suite was detected. The Suite rejected a data package due to improper format. Please see if all images are available in the Suite. If you find images missing, add an additional imaging step to recover the data. |
| j) | Unidentified error occurs during upgrade | Please check the log file for following entries: "Backup failed: Backup fail: There is not enough disk space for backup" or "Data size: x MB, free disk space: x MB" |
| k) | Error 711 and Error 995 | The error can occur if there is a connectivity issue detected between instrument and Software Suite. Please check your connection settings. A renew of QIAcuity Software Suite certificate could help. Please refer to section Renew certificate. |
| l) | Error 300 during startup of instrument | The Thermocycle requires a minimum ambient temperature inside the instrument of 17°C. Thus, the Error 300 might occur in locations, where room temperature could sink below 17°C. If the Error 300 is raised during start up, when the instrument has been shut down for a longer period, a warm-up phase is required. Please turn on the instrument for 30–60 min. After this time clear the Error and restart. The instrument should start without an Error. If the Error persists, please contact QIAGEN Technical Services. |
| m) | Error 33 | The error can occur if the instrument was shut down with plates loaded to all plate slots or an error occurred in a fully loaded instrument. During startup, the instrument starts a recovery sequence requiring a free slot in the drawer. Therefore, Error 33 is raised and asks you to unload at least 1 slot, clear the error, and restart. |
| n) | Empty running screen and CSW version 0.0.0.0 and no connection with Network and Software Suite | The error can occur very rarely after clearing errors and can be solved by restarting the instrument. |

9.7 Accessing the system status and clearing errors

Note: Only administrators can access the instrument status.

The QIAcuity allows you to see the status of each of its modules. This is especially useful when a hardware error occurs. Details about errors that occurred on the instrument are shown in the System Status section. After viewing the information, administrators can clear errors and restart the instrument to initialize all the modules.

To access the System Status environment and clear errors, follows the steps below.

1. On the toolbar, tap **Tools**.
2. Tap Servicing.
3. In the Servicing tab, tap **System Status**.

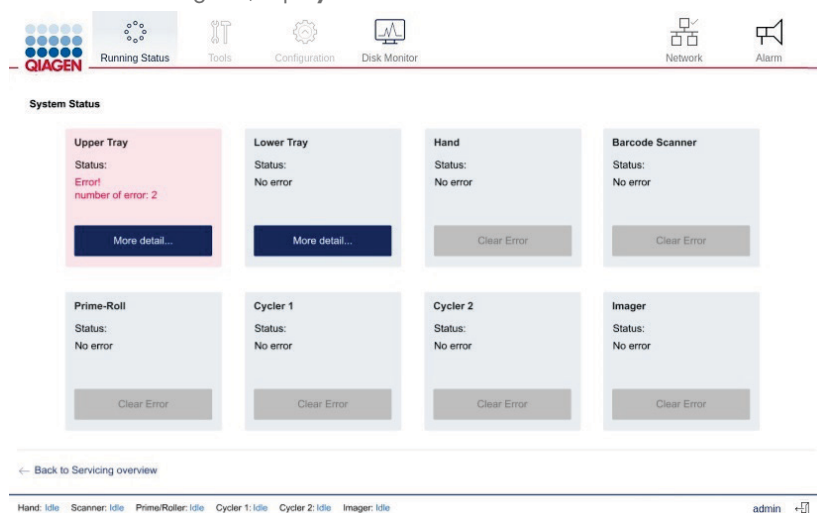

System status environment on the QIAcuity Eight after an error occurs.

4. To clear an error, tap **Clear error**.
5. If the error that occurred affects the tray(s), tap **More details**. To clear a tray-related error, tap **Clear error in the dialog**. The dialog box contains five items that can be cleared for each tray, such as motor and slot numbers (based on Instrument Version).

Note: In QIAcuity Eight, the **More details** button is located in the Upper Tray and Lower Tray panes. In the QIAcuity Four and QIAcuity One, the **More details** button is located in the Tray pane.

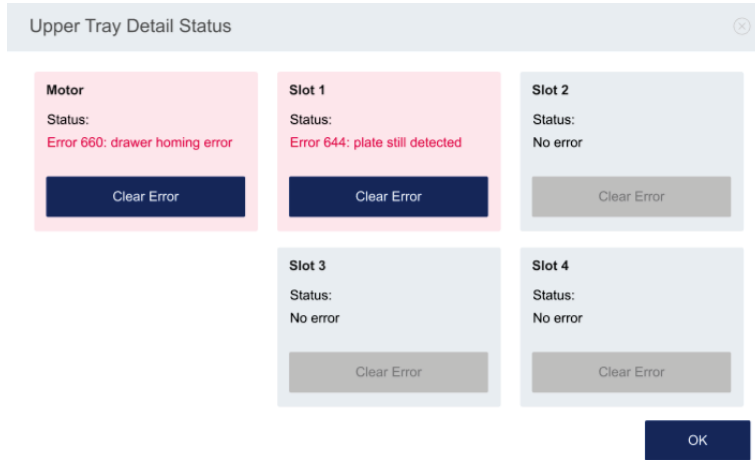

6. Restart the instrument. The instrument initializes and all modules are returned to their home positions.

Note: If the affected module is not working after you cleared the error and restarted the instrument, contact QIAGEN Technical Services.

10 Glossary

Glossary terms are listed in alphabetical order.

Term	Description
Acquisition	The collection of fluorescent data at the end of the run
Channel	A channel consists of a light emitting diode (LED) with an excitation filter paired with an emission filter The LED and excitation filter excite samples at a given wavelength. Fluorescence emitted by samples is passed through the emission filter, before being detected by the camera.
Confidence Interval	Indicates the range of values that is likely to contain the true parameter value
dPCR parameters	Parameters specifying a PCR run (e.g., number of cycles, temperature, acquisitions, etc.)
Environment	The QIAcuity Software Suite consists of several environments (e.g., "Plates", "Templates", "Analysis", "Report"). In these environments, certain tasks can be performed, such as setting up a run or analyze data.
Error code	A 3- or 4-digit number that indicates an error of the QIAcuity
Exposure duration	The length of time the samples are exposed to light during the fluorescens acquisition
Gain	A setting to amplify the fluorescence signal If the gain is set too high, the signal is oversaturated. If the gain is set too low, it is not possible to differentiate signal from background noise.
GUI	Graphical user interface
Initialization	An operation performed automatically when the QIAcuity is switched on or by initiating a self-check of the instrument, if required
Nanoplate	dPCR plate with several single partitions
Optical configuration	The optical configuration of a QIAcuity instrument is described by the available channels to detect fluorescence signals. The optical configuration differs between different types of the QIAcuity instruments.
Partition	Compartment in the Nanoplate where the PCR reaction takes place
Plate seal	Foil to be applied on top of the plate to prevent evaporation and contamination
Power switch	A button located at the front of the QIAcuity in the bottom-right corner It allows the user to switch the QIAcuity on and off; inner position is ON and outer position is OFF.
Priming	Filling of the partitions with the reaction volume
Rolling	Separation of the single partitions filled with the reaction volume
Support Package	Information wrapped up in a *.zip file to be sent via an email program to QIAGEN Technical Services to inform QIAGEN what went wrong at the customer's site and how to help the customer
Touchscreen	The user interface that allows the user to operate the QIAcuity
VPF	Volume Precision Factor. The VPF specifies the exact cycled volume of a well within a Nanoplate and therefore further increases precision of concentration calculation in each well.

11 Appendix A – Technical Data

QIAGEN reserves the right to change specifications at any time.

11.1 Operating conditions

Power	100–240 V AC, 50/60 Hz, Mains supply voltage fluctuations are not to exceed 10% of nominal supply voltages. Maximum power consumption: QIAcuity One, 2plex: 1000VA QIAcuity One, 5plex: 1000VA QIAcuity Four: 1000VA QIAcuity Eight: 1500VA
Fuse	2x T12A L 250V
Overvoltage category	II
Air temperature	15–32°C (59.0–89.6°F)
Relative humidity	10–75% (non-condensing)
Altitude	Up to 2000 m (6500 ft.)
Place of operation	For indoor use only
Pollution level	2
Environmental class	3K21 (IEC 60721-3-3)

11.2 Transport conditions

Air temperature -25°C to 60°C (-13°F to 140°F) in manufacturer's package

Relative humidity 5% to 85% (non-condensing)

Environmental class 2K11 & 2M4 (IEC 60721-3-2)

Ambient pressure 700 to 1060 hPa

11.3 Storage conditions

Air temperature 5°C to 40°C (41°F to 104°F) in manufacturer's package

Relative humidity 5% to 85% (non-condensing)

Environmental class 1K21 (IEC 60721-3-1)

Ambient pressure 700 to 1060 hPa

11.4 Mechanical data and hardware features

Dimensions Four/Eight Width: 60 cm (23.6 in.)
Height: 58 cm (22.8 in.)
Depth: 65 cm (25.6 in.)

Dimensions One Width: 38 cm (15.0 in.)
Height: 45 cm (17.7 in.)
Depth: 65 cm (25.6 in.)

Mass QIAcuity One: 36.0 kg (79.4 lb.)
QIAcuity Four: 43.0 kg (94.8 lb.)
QIAcuity Eight: 55.0 kg (121.3 lb.)
Accessories: 3.0 kg (6.6 lb.)

Thermal specifications
 Process temperature: 35°C to 99°C
 Ramp rate: approx. 3.0°C/s
 Accuracy: ±1°C
 Homogeneity (over plate surface): ±1°C
 The QIAcuity Eight features two Thermocyclers that are operated in parallel

Optical specifications
 The 2-plex version features the channels Green and Yellow and the 5-plex version all following channels:

Channel	Green	Yellow	Orange	Red	Crimson
Excitation in nm	463–503	514–535	543–565	570–596	590–640
Emission in nm	518–548	550–564	580–606	611–653	654–692

Excitation by high power white LED with average 4750 lumens
 Image acquisition by CMOS camera with 6.3MP

Capacity
 Up to 96 samples per plate. Maximum plate capacity depends on the configuration (One, Four, Eight)

Touchscreen (Four/Eight)
 10.1" LCD Touch, active area 218.0 x 136.6 mm, resolution 1280*800 HD

Touchscreen (One)
 7.0" LCD Touch, active area 150.4 x 94.2 mm, resolution 1280*800 HD

Acoustic emission
 QIAcuity One: Max. 57.4 dB(A)
 QIAcuity Four/Eight: Max. 54.6 dB (A)

USB drive
 USB2.0 8GB
 Compatible OS: Windows 8, Windows 7, Windows Vista, Windows XP (SP3 or later); Mac OS X 10.1 or later
 Operating temperature range: 0 to 35°C
 Operating humidity range: 10 to 90% (with no condensation)
 Storage temperature range: -20 to 60°C (-4 to 140°F)
 Storage humidity range: 10 to 90% (with no condensation)
 Formatting: FAT32

Handheld scanner (optional)
 Scan Pattern: Area Image (1280 x 800-pixel array)
 Motion Tolerance: Up to 89 cm/s (35 in/s)
 Print Contrast Ratio: 15% (minimum)
 Decode Capability: Reads standard 1D, 2D, Postal and stacked codes
 Resolution: 1D Linear: 0.102 mm/4 mils; PDF417: 0.127 mm/5 mils; Data Matrix: 0.195 mm/7.5 mils

11.5 Declaration of conformity

Name and address of the legal manufacturer:

QIAGEN GmbH
QIAGEN Strasse 1
40724 Hilden
Germany

An up-to-date declaration of conformity can be requested from QIAGEN Technical Services.

11.6 Waste Electrical and Electronic Equipment (WEEE)

This section provides information about disposal of waste electrical and electronic equipment by users.

The crossed-out wheeled bin symbol (see below) indicates that this product must not be disposed of with other waste; it must be taken to an approved treatment facility or to a designated collection point for recycling, according to local laws and regulations.

The separate collection and recycling of waste electronic equipment at the time of disposal helps to conserve natural resources and ensures that the product is recycled in a manner that protects human health and the environment.



Recycling can be provided by QIAGEN upon request at additional cost. In the European Union, in accordance with the specific WEEE recycling requirements and where a replacement product is being supplied by QIAGEN, free recycling of its WEEE-marked electronic equipment is provided.

To recycle electronic equipment, contact your local QIAGEN sales office for the required return form. Once the form is submitted, you will be contacted by QIAGEN either to request follow-up information for scheduling collection of the electronic waste or to provide you with an individual quote.

11.7 California Proposition 65

<p>WARNING</p> 	<p>Using this product can expose you to chemicals including lead acetate, which is known to the state of California to cause cancer and DEHP, which is known to the State of California to cause birth defects and/or other reproductive harm. For more information, go to www.P65Warnings.ca.gov</p>
---	---

11.8 Liability Clause

QIAGEN shall be released from all obligations under its warranty in the event repairs or modifications are made by persons other than its own personnel, except in cases where the Company has given its written consent to perform such repairs or modifications.

All materials replaced under this warranty will be warranted only for the duration of the original warranty period, and in no case beyond the original expiration date of original warranty unless authorized in writing by an officer of the Company. Read-out devices, interfacing devices, and associated software will be warranted only for the period offered by the original manufacturer of these products. Representations and warranties made by any person, including representatives of QIAGEN, which are inconsistent or in conflict with the conditions in this warranty shall not be binding upon the Company unless produced in writing and approved by an officer of QIAGEN.

11.9 Declaration list of China RoHS (SJ/T 11364-2014)

The environmental friendly use period of the QIAcuity instruments is 25 years. The marking for the Restricted Use of Hazardous Substances in Electronic and Electrical Products (SJ/T 11364-2014) is shown in Table 21.

Table 21. Marking for the restricted use of hazardous substances in electronic and electrical products (SJ/T 11364-2014)

Part Name - 部件名称	Toxic or Hazardous Substances and Element - 有毒或有害的物质成分					
	Lead (Pb) 铅	Mercury (Hg) 汞	Cadmium (Cd) 镉	Hexavalent Chromium (Cr6+) 六价铬	Polybrominated biphenyls (PBB) 多溴联苯	Polybrominated diphenyl ethers (PBDE) 多溴联苯醚
Plastics - 塑料						
Enclosure/Plastics parts - 外壳/塑料部件	○	○	○	○	○	○
Mechanical units - 机械部分						
Chassis/Moving parts - 底盘/可动部分	○	○	○	○	○	○
Shielding/apertures/ covers - 罩/光圈/盖	○	○	○	○	○	○
Electrical Units - 电器部分						
PCBs a. components/ Sensors - 印刷电路板部分/传感器	X	○	○	○	○	○
Power supply - 电源	X	○	○	○	○	○
Cables - 电缆						
Connecting cables - 连接电缆	○	○	○	○	○	○
Motors - 电机						
Motors/Pumps/Fans - 电机/泵/风扇	○	○	○	○	○	○
Optical Parts - 光□□□						
Filter, Lenses - 滤光器/镜头	○	○	○	○	○	○
Heating Unit - 加热装置						
Thermocycler - 散热片	○	○	○	○	○	○

Note: This table is prepared in accordance with the provisions of SJ/T 11364.

○: Indicates that this toxic or hazardous substance contained in all of the homogeneous materials for this part is below the limit requirement in GB/T 26572.

○: 代表用于此部件的所有同类型的包含该种有毒或者有害物质的材料均在GB/T 26572的规定界限以下

X: Indicates that this toxic or hazardous substance contained in at least one of the homogeneous materials used for this part may be above the limit requirement in GB/T 26572.

X: 代表用于此部件的至少一种此类型的包含该种有毒或者有害物质的材料可能在GB/T 26572的规定界限以上

12 Appendix B – QIAcuity Accessories

For more information and an up-to-date list of available protocols, visit www.qiagen.com.

12.1 Ordering information

Product	Contents	Cat. no.
QIAcuity One, 2plex Platform System FUL-1 *	One-plate digital PCR instrument for detecting up to 2 fluorescent dyes, notebook computer, Nanoplate Roller, USB flash memory, and QIAcuity Software Suite: includes installation, training, full agreement for 1 year with a 2-business day response time, and 1 preventive maintenance visit	911015
QIAcuity One, 5plex Platform System FUL-1 *	One-plate digital PCR instrument for detecting up to 2 fluorescent dyes, notebook computer, Nanoplate Roller, USB flash memory, and QIAcuity Software Suite: includes installation, training, full agreement for 1 year with a 2-business day response time, and 1 preventive maintenance visit	911035
QIAcuity Four Platform System FUL-1 *†	Four-plate digital PCR instrument for detecting up to 5 fluorescent dyes, notebook computer, barcode scanner, Nanoplate Roller, USB flash memory, and QIAcuity Software Suite; Includes installation, training, full agreement for 1 year with a 2-business day response time, and 1 preventive maintenance visit	911045
QIAcuity Eight Platform System FUL-1 *†	Eight-plate digital PCR instrument for detecting up to 5 fluorescent dyes, notebook computer, barcode scanner, Nanoplate Roller, USB flash memory, and QIAcuity Software Suite: includes installation, training, full agreement for 1 year with a 2-business day response time, and 1 preventive maintenance visit	911055
QIAcuity, IQ/OQ product	Installation Qualification and Operational Qualification of QIAcuity provides documented verification that the instrument has been properly installed, and is operating according to the manufacturer's specifications. IQ/OQ Service is an on-site qualification service provided by a certified QIAGEN Service Specialist. This includes labor and travel	9245414
Barcode Hand Scanner, QIAcuity	Separate 2D barcode scanner for reading of QIAcuity Nanoplate IDs outside of the QIAcuity instrument	911106

* Additional instrument and Service bundles are available.

† For all systems, Installation and Training is included but are additionally available as separate service offerings. For specific catalog numbers and additional information, visit www.qiagen.com or contact your local sales representative.

Roller, QIAcuity	Nanoplate Roller for fixing the Nanoplate seal on QIAcuity Nanoplates	911105
Air Filter, QIAcuity One (1)	Replacement air inlet filter for QIAcuity One	9026699
Air Filter, QIAcuity Four/Eight (1)	Replacement air inlet filter for QIAcuity Four and QIAcuity Eight	9026700
QIAcuity Nanoplate 26k 24-well (10)	24-well dPCR Nanoplate with 26K partitions and 40 µl reaction volume per well, including Nanoplate seals	250001
QIAcuity Nanoplate 8.5k 24-well (10)	24-well dPCR Nanoplate with 8.5K partitions and 12 µl reaction volume per well, including Nanoplate seals	250011
QIAcuity Nanoplate 8.5k 96-well (10)	96-well dPCR Nanoplate with 8.5K partitions and 12 µl reaction volume per well, including Nanoplate seals	250021
Nanoplate Seals (11)	Nanoplate seal for sealing QIAcuity Nanoplates	250099
Nanoplate Tray (2)	Nanoplate Tray improving plate-handling during pipetting or carrying	250098
QIAcuity Probe PCR Kit (1 ml)	1 ml 4x concentrated QIAcuity Probe Mastermix, 2 x 1.9 ml Water	250101
QIAcuity Probe PCR Kit (5 ml)	5 x 1 ml 4x concentrated QIAcuity Probe Mastermix, 8 x 1.9 ml Water	250102
QIAcuity Probe PCR Kit (25 ml)	5 x 5 ml 4x concentrated QIAcuity Probe Mastermix, 4 x 20 ml Water	250103
QIAcuity EG PCR Kit (1 ml)	1 ml 3x concentrated QIAcuity EvaGreen Mastermix, 2 x 1.9 ml Water	250111
QIAcuity EG PCR Kit (5 ml)	5 x 1 ml 3x concentrated QIAcuity EvaGreen Mastermix, 8 x 1.9 ml Water	250112
QIAcuity EG PCR Kit (25 ml)	5 x 5 ml 3x concentrated QIAcuity EvaGreen Mastermix, 4 x 20 ml Water	250113

For up-to-date licensing information and product-specific disclaimers, see the respective QIAGEN kit handbook or user manual. QIAGEN kit handbooks and user manuals are available at www.qiagen.com or can be requested from QIAGEN Technical Services or your local distributor.

13 Appendix C – Informations de sécurité

Avant d'utiliser le QIAcuity, il est impératif de lire attentivement ce manuel et de porter attention aux informations de sécurité. Pour garantir un fonctionnement de l'appareil en toute sécurité et le maintenir en bon état de marche, il est impératif de suivre les instructions et les informations de sécurité fournies dans le manuel.

Remarque : les traductions française et allemande des informations de sécurité sont disponibles à l'annexe C – Informations de sécurité et à l'annexe D – Sicherheitshinweise.

Les types d'informations de sécurité suivants sont fournis dans ce manuel.

AVERTISSEMENT 	Le terme AVERTISSEMENT est utilisé pour indiquer des situations pouvant entraîner des blessures personnelles pour vous ou d'autres personnes. Les détails concernant ces circonstances sont donnés dans un encadré identique à celui-ci.
---	--

ATTENTION 	Le terme ATTENTION est utilisé pour indiquer des situations pouvant entraîner un endommagement de l'appareil ou d'autres équipements. Les détails concernant ces circonstances sont donnés dans un encadré identique à celui-ci.
--	--

Les conseils dispensés dans ce manuel ont pour but de venir compléter les exigences de sécurité habituelles en vigueur dans le pays de l'utilisateur, et non de s'y substituer.

13.1 Utilisation appropriée

AVERTISSEMENT T 	Risque de dommages corporels et matériels [W1] Une utilisation inappropriée du QIAcuity peut entraîner des blessures corporelles ou une détérioration de l'appareil. Le QIAcuity ne doit être utilisé que par du personnel qualifié ayant été convenablement formé. L'entretien du QIAcuity ne doit être effectué que par un spécialiste de l'entretien sur site QIAGEN.
--	--

Procéder à la maintenance comme décrit dans la section Procédures de maintenance. QIAGEN facture les réparations dues à une maintenance incorrecte.

AVERTISSEMENT 	Risque de dommages corporels et matériels [W2] L'appareil QIAcuity est trop lourd pour être soulevé par une seule personne. Afin d'éviter tout accident corporel et toute détérioration du matériel, ne pas soulever l'appareil seul. La plaque inférieure doit être utilisée pour le levage. Ne pas soulever l'appareil en le tenant par l'écran tactile.
---	---

AVERTISSEMENT 	Risque de dommages corporels et matériels Ne pas essayer de déplacer le QIAcuity pendant qu'il est en marche.	[W3]
---	---	-------------

ATTENTION 	Détérioration de l'appareil Éviter de renverser de l'eau ou des produits chimiques sur le QIAcuity. La détérioration due à la projection d'eau ou de produits chimiques annulera la garantie.	[C1]
---	---	-------------

En cas d'urgence, éteindre le QIAcuity à l'aide de l'interrupteur d'alimentation situé à l'arrière de l'appareil et débrancher le câble d'alimentation de la prise secteur.

ATTENTION 	Détérioration de l'appareil Utiliser les consommables pour QIAcuity avec le QIAcuity. Ne pas utiliser de plaques sans couvercles. Les détériorations causées par l'utilisation d'autres consommables annulent la garantie.	[C2]
---	--	-------------

ATTENTION 	Détérioration de l'appareil Ne pas faire tomber d'objets dans l'appareil quand le plateau de plaque est éjecté.	[C3]
--	---	-------------

AVERTISSEMENT 	Risque d'explosion Le QIAcuity est conçu pour être utilisé avec les réactifs et les substances fournis avec les kits QIAGEN ou autrement que de la façon décrite dans le mode d'emploi correspondant. L'utilisation d'autres réactifs et d'autres substances peut provoquer un incendie ou une explosion.	[W4]
---	---	-------------

ATTENTION 	Détérioration de l'appareil Ne pas empiler les instruments et ne pas placer de produits sur le QIAcuity.	[C4]
---	--	-------------

ATTENTION 	Détérioration de l'appareil Ne pas vous appuyer contre l'écran tactile lorsqu'il est déboîté.	[C5]
---	---	-------------

13.2 Sécurité électrique

Remarque : avant l'entretien, débrancher le cordon d'alimentation de la prise de courant.

AVERTISSEMENT 	<p>Danger électrique [W5]</p> <p>Toute interruption du conducteur de protection (conducteur de terre/de masse) à l'intérieur ou à l'extérieur de l'appareil ou toute déconnexion de la borne du conducteur de protection est susceptible de rendre l'appareil dangereux.</p> <p>Toute interruption intentionnelle est interdite.</p> <p>Tensions mortelles à l'intérieur de l'appareil</p> <p>Lorsque l'appareil est relié à l'alimentation, les bornes peuvent être sous tension et l'ouverture de capots ou le retrait d'éléments risque d'exposer des éléments sous tension.</p>
---	--

AVERTISSEMENT 	<p>Endommagement des composants électroniques [W6]</p> <p>Avant de mettre l'appareil SOUS tension, vérifier que vous utilisez la bonne tension d'alimentation.</p> <p>L'utilisation d'une tension d'alimentation incorrecte risque d'endommager les composants électroniques.</p> <p>Pour prendre connaissance de la tension d'alimentation recommandée, consulter les spécifications indiquées sur la plaque signalétique de l'appareil.</p>
---	---

AVERTISSEMENT 	<p>Risque de décharge électrique [W7]</p> <p>Ne pas ouvrir pas les panneaux du QIAcuity.</p> <p>Risque de dommages corporels et matériels</p> <p>Effectuer uniquement la maintenance qui est décrite spécifiquement dans le présent manuel d'utilisation.</p>
---	--

Afin que le QIAcuity fonctionne de manière satisfaisante et en toute sécurité, suivre ces instructions :

- Le câble d'alimentation doit être relié à une prise d'alimentation disposant d'un conducteur de protection (terre/masse).
- Ne pas modifier ou remplacer des composants internes de l'appareil.
- Ne pas faire fonctionner l'appareil en ayant retiré des capots ou des composants.
- Si un liquide s'est répandu à l'intérieur de l'appareil, l'éteindre, le déconnecter de la prise secteur et prendre contact avec les services techniques de QIAGEN.

Si l'appareil présente un danger électrique, empêcher le reste du personnel de s'en servir et contacter les services techniques de QIAGEN.

L'appareil peut présenter un danger électrique dans les cas suivants :

- L'appareil ou le câble d'alimentation semble être détérioré.
- Il a été stocké dans des conditions défavorables pendant une longue période.

- Il a subi des chocs sévères durant le transport.
- Des liquides entrent en contact direct avec les composants électriques du QIAcuity.

13.3 Environnement

13.3.1 Conditions de fonctionnement

AVERTISSEMENT 	Atmosphère explosive [W8] Le QIAcuity n'est pas conçu pour être utilisé dans une atmosphère explosive.
---	---

ATTENTION 	Détérioration de l'appareil [C6] L'exposition à la lumière solaire directe peut provoquer le blanchiment de certains éléments de l'appareil et détériorer les pièces en plastique. Le QIAcuity doit être tenu à l'abri de la lumière directe du soleil.
---	---

ATTENTION 	Risque de surchauffe [C7] Afin de garantir une bonne ventilation, laisser un dégagement d'au moins 10 cm sur les côtés et à l'arrière du QIAcuity. Les fentes et les ouvertures qui garantissent la ventilation du QIAcuity ne doivent pas être obstruées.
---	--

13.4 Sécurité biologique

Les prélèvements et les réactifs contenant des matières provenant d'êtres humains doivent être considérés comme potentiellement infectieux. Utiliser des procédures de laboratoire sûres, comme décrites dans des publications telles que Biosafety in Microbiological and Biomedical Laboratories, HHS (www.cdc.gov/labs/BMBL.html).

13.4.1 Échantillons

Les échantillons peuvent contenir des agents infectieux. Vous devez connaître le risque pour la santé que ces agents représentent et vous devez utiliser, stocker et mettre au rebut ce genre d'échantillons conformément aux règles de sécurité nécessaires.

AVERTISSEMENT 	Échantillons contenant des agents infectieux [W9] Certains échantillons utilisés avec cet appareil peuvent contenir des agents infectieux. Manipuler ces échantillons avec la plus grande précaution et conformément aux règles de sécurité nécessaires. Toujours porter des lunettes de protection, 2 paires de gants et une blouse de laboratoire. La personne responsable (par exemple, le directeur du laboratoire) doit prendre les précautions nécessaires afin de garantir que le lieu de travail environnant est sûr et que les opérateurs de l'appareil sont convenablement formés et ne sont pas exposés à des niveaux dangereux d'agents infectieux comme cela est défini dans les fiches techniques santé-sécurité (Material Safety Data Sheets, MSDSs) ou dans les documents de l'OSHA *, de l'ACGIH† ou du COSHH‡ applicables. L'évacuation des vapeurs et la mise au rebut des déchets doivent être effectuées conformément à toutes les réglementations et lois nationales, régionales et locales relatives à la santé et à la sécurité.
---	--

13.5 Produits chimiques

AVERTISSEMENT 	Produits chimiques dangereux [W10] Certains produits chimiques utilisés avec cet appareil peuvent être dangereux ou le devenir après l'exécution du cycle du protocole. Toujours porter des lunettes de protection, des gants et une blouse de laboratoire. La personne responsable (par exemple, le directeur de laboratoire) doit prendre les précautions nécessaires afin de garantir que le lieu de travail environnant est sûr et que les opérateurs de l'appareil ne sont pas exposés à des niveaux dangereux de substances toxiques (chimiques ou biologiques) comme cela est défini dans les fiches techniques de sécurité (Safety Data Sheets, SDS) ou dans les documents de l'OSHA,* de l'ACGIH† ou du COSHH‡ applicables. L'évacuation des vapeurs et la mise au rebut des déchets doivent être effectuées conformément à toutes les réglementations et lois nationales, régionales et locales relatives à la santé et à la sécurité.
---	--

* OSHA : Occupational Safety and Health Administration (Administration pour la santé et la sécurité du travail) (États-Unis d'Amérique)

† ACGIH : American Conference of Government Industrial Hygienists (Conférence américaine des hygiénistes industriels gouvernementaux) (États-Unis d'Amérique).

‡ COSHH : Control of Substances Hazardous to Health (Contrôle des substances dangereuses pour la santé) (Royaume-Uni).

13.6 Sécurité de maintenance

AVERTISSEMENT/ ATTENTION 	Risque de dommages corporels et matériels [W11] Effectuer uniquement la maintenance qui est décrite spécifiquement dans le présent manuel d'utilisation.
--	--

AVERTISSEMENT 	Risque d'incendie [W12] Ne pas laisser le liquide de nettoyage ou les agents de décontamination entrer en contact avec les Pièce électriques du QIAcuity.
---	---











ATTENTION 	Détérioration de l'appareil [C8] Ne pas utiliser de produit à base d'eau de Javel, de solvants ou de réactifs contenant des acides, des agents alcalins ou des produits abrasifs pour nettoyer le QIAcuity.
---	---

ATTENTION 	Détérioration de l'appareil [C9] Ne pas utiliser pas de flacons pulvérisateurs contenant de l'alcool ou un agent désinfectant pour nettoyer les surfaces du QIAcuity.
--	---

13.7 Sécurité contre les rayonnements

AVERTISSEMENT 	Risque de dommages corporels [W13] Lumière laser avec niveau de danger 2 : Ne pas regarder fixement le faisceau lumineux lors de l'utilisation du lecteur de code-barres portable.
---	--

13.8 Symboles sur le QIAcuity

Symbole	Emplacement	Description
	Plaque signalétique à l'arrière de l'appareil	Marquage CE pour la conformité européenne
	Plaque signalétique à l'arrière de l'appareil	Marquage UKCA pour la conformité UK
	Plaque signalétique à l'arrière de l'appareil	Label CSA pour le Canada et les États-Unis
	Plaque signalétique à l'arrière de l'appareil	Marquage RCM pour l'Australie et la Nouvelle-Zélande
	Plaque signalétique à l'arrière de l'appareil	Marquage RoHS pour la Chine (restriction de l'utilisation de certaines substances dangereuses dans les équipements électriques et électroniques)
	Plaque signalétique à l'arrière de l'appareil	Marquage de déchets d'équipements électriques et électroniques (DEEE) pour l'Europe
	Plaque signalétique à l'arrière de l'appareil	Fabricant légal
	Plaque signalétique à l'arrière de l'appareil	Consulter le mode d'emploi
	Plaque signalétique à l'arrière de l'appareil	Voir chapitre Informations de sécurité pour les risques
	Plaque signalétique à l'arrière de l'appareil	Date de fabrication
	Sur le tiroir	Risque biologique – certains échantillons utilisés avec cet appareil peuvent contenir des agents infectieux et doivent être manipulés avec des gants.

14 Appendix D – Sicherheitshinweise

Vor der Inbetriebnahme des QIAcuity sollten Sie dieses Benutzerhandbuch sorgfältig durchlesen und die Sicherheitshinweise beachten. Die Anweisungen und Sicherheitshinweise in diesem Benutzerhandbuch müssen vom Benutzer befolgt werden, um einen sicheren Betrieb des Geräts zu gewährleisten und das Gerät in einem sicheren Zustand zu erhalten.

Hinweis: Übersetzungen der Sicherheitshinweise in Französisch und Deutsch finden Sie in Anhang C – Informations de sécurité und Anhang D – Sicherheitshinweise.

In diesem Handbuch werden die folgenden Typen von Sicherheitshinweisen verwendet.

WARNUNG 	Der Begriff WARNUNG weist Sie auf Situationen hin, in denen eine Verletzungsgefahr für Sie und andere Personen besteht. Nähere Einzelheiten über diese Situationen werden in einem Textfeld wie diesem beschrieben.
---	--

VORSICHT 	Der Begriff VORSICHT wird verwendet, um Sie über Situationen zu informieren, in denen das Gerät oder andere Geräte beschädigt werden könnten. Nähere Einzelheiten über diese Situationen werden in einem Textfeld wie diesem beschrieben.
---	--

Die in diesem Handbuch enthaltenen Hinweise sollen die im jeweiligen Land des Anwenders geltenden Sicherheitsbestimmungen nicht ersetzen, sondern lediglich ergänzen.

14.1 Sachgemäße Handhabung

WARNUNG 	Gefahr von Personen- und Sachschäden [W1] Die unsachgemäße Anwendung des QIAcuity kann zu Verletzungen des Benutzers oder zur Beschädigung des Geräts führen. Die Bedienung des QIAcuity darf nur durch qualifiziertes, entsprechend geschultes Personal erfolgen. Die Instandhaltung des QIAcuity darf nur durch einen Service-Spezialisten des QIAGEN Außendienstes durchgeführt werden.
---	--

Führen Sie alle Wartungsarbeiten gemäß den Anweisungen im Abschnitt Wartungsarbeiten dieses Handbuchs durch. QIAGEN stellt Reparaturen, die auf nicht fachgerecht durchgeführte Wartungsmaßnahmen zurückzuführen sind, in Rechnung.

WARNUNG 	Gefahr von Personen- und Sachschäden [W2] Der QIAcuity ist sehr schwer und sollte nicht von einer Person angehoben werden. Heben Sie das Gerät nicht allein an, um eine Verletzung und/oder Beschädigung des Geräts zu vermeiden. Beim Heben ist das Gerät an der Unterseite anzufassen. Fassen Sie das Gerät zum Heben nicht am Touchscreen an.
---	---

WARNUNG 	Gefahr von Personen- und Sachschäden Bewegen Sie den QIAcuity auf keinen Fall während des Betriebs.	[W3]
---	---	-------------

VORSICHT 	Beschädigung des Geräts Verschütten Sie keine Flüssigkeiten oder Chemikalien auf dem QIAcuity. Durch verschüttetes Wasser oder verschüttete Chemikalien verursachte Schäden führen zum Erlöschen der Garantie.	[C1]
--	--	-------------

Schalten Sie den QIAcuity im Notfall am Netzschalter auf der Rückseite des Geräts AUS und ziehen Sie das Netzkabel aus der Netzsteckdose.

VORSICHT 	Beschädigung des Geräts Verwenden Sie nur für den QIAcuity vorgesehene Verbrauchsmaterialien mit dem QIAcuity. Verwenden Sie keine Platten ohne angebrachte Versiegelung. Kommt es bei der Verwendung anderer Verbrauchsartikeln anderer Hersteller zu Geräteschäden, erlischt Ihre Garantie.	[C2]
--	---	-------------

VORSICHT 	Beschädigung des Geräts Lassen Sie keine Gegenstände in das Gerät fallen, wenn das Plattentablett ausgeworfen wird.	[C3]
---	---	-------------

WARNUNG 	Explosionsgefahr Der QIAcuity darf ausschließlich mit Reagenzien und Substanzen aus den QIAGEN Kits bzw. gemäß den Angaben in der entsprechenden Gebrauchsanweisung verwendet werden. Die Verwendung anderer Reagenzien und Substanzen kann zu einem Brand oder zu einer Explosion führen.	[W4]
---	--	-------------

VORSICHT 	Beschädigung des Geräts Stapeln Sie keine Geräte aufeinander und stellen Sie keine Gegenstände auf den QIAcuity.	[C4]
--	--	-------------

VORSICHT 	Beschädigung des Geräts Lehnen Sie sich nicht an den Touchscreen, wenn er herausgezogen ist.	[C5]
--	--	-------------

14.2 Schutz vor Stromschlag

Hinweis: Ziehen Sie das Netzanschlusskabel aus der Steckdose, bevor Sie Instandhaltungs-/Wartungsarbeiten an einem Gerät vornehmen.

WARNUNG 	Stromschlaggefahr [W5] Jede Unterbrechung des Schutzleiters (Erdungs- bzw. Masseleiter) im Gerät oder außerhalb des Geräts und jede Abtrennung des Schutzleiters am Anschluss der Netzleitung erhöht die Gefahr eines Stromschlags. Eine absichtliche Unterbrechung der Schutzleiterverbindung ist verboten. Gefährliche Spannung im Gerät Wenn das Gerät an die Stromversorgung angeschlossen ist, sind die Anschlussstellen spannungsführend. Durch das Öffnen der Abdeckungen oder das Entfernen von Gehäuseteilen können spannungsführende Komponenten freigelegt werden.
---	--

WARNUNG 	Beschädigung von elektronischen Bauteilen [W6] Stellen Sie vor dem Einschalten des Geräts sicher, dass die korrekte Versorgungsspannung verwendet wird. Eine falsche Versorgungsspannung kann Schäden an der Elektronik hervorrufen. Überprüfen Sie die empfohlene Versorgungsspannung anhand der technischen Daten auf dem Typenschild des Geräts.
---	--

WARNUNG 	Gefahr durch Stromschlag [W7] Öffnen Sie keine der Abdeckplatten des QIAcuity. Gefahr von Personen- und Sachschäden Es dürfen nur Wartungsarbeiten ausgeführt werden, die in diesem Benutzerhandbuch konkret beschrieben sind.
---	--

Um einen zufriedenstellenden und sicheren Betrieb des QIAcuity zu gewährleisten, befolgen Sie bitte die nachstehenden Hinweise:

- Das Netzkabel muss an eine Wechselstrom-Steckdose mit Schutzleiter (Erdungs-/Masseleiter) angeschlossen werden.
- Nehmen Sie im Geräteinneren keine Einstellungen an Geräteteilen vor und wechseln Sie keine Teile aus.
- Nehmen Sie das Gerät nicht in Betrieb, wenn Abdeckungen oder Teile entfernt worden sind.
- Falls Flüssigkeit auf dem Gerät verschüttet wird und hineinläuft, schalten Sie es sofort AUS, ziehen Sie den Netzstecker und setzen Sie sich mit dem Technischen Service von QIAGEN in Verbindung.



Falls die elektrische Sicherheit bei der Bedienung des Geräts nicht mehr gewährleistet werden kann, muss das Gerät gegen Benutzung durch darüber nicht informiertes Personal gesichert werden. Kontaktieren Sie anschließend den Technischen Service von QIAGEN.

Die elektrische Sicherheit des Geräts ist nicht mehr gegeben, wenn:

- das Gerät oder das Netzkabel beschädigt erscheint;
- das Gerät für längere Zeit unter ungünstigen Bedingungen gelagert wurde;
- das Gerät unsachgemäß transportiert worden ist.
- Flüssigkeiten in direkten Kontakt mit elektrischen Komponenten des QIAcuity kommen.

14.3 Umgebung

14.3.1 Betriebsbedingungen

<p>WARNUNG</p> 	<p>Explosive Atmosphäre [W8]</p> <p>Der QIAcuity ist nicht für den Gebrauch in explosionsfähiger Atmosphäre vorgesehen.</p>
<p>VORSICHT</p> 	<p>Beschädigung des Geräts [C6]</p> <p>Direktes Sonnenlicht kann zum Ausbleichen von Teilen des Geräts führen und Schäden an Kunststoffteilen verursachen.</p> <p>Der QIAcuity muss an einem Ort aufgestellt werden, an dem er vor direkter Sonneneinstrahlung geschützt ist.</p>
<p>VORSICHT</p> 	<p>Überhitzungsgefahr [C7]</p> <p>Vergewissern Sie sich, dass ein Mindestabstand von 10 cm zwischen Seitenwänden und Rückseite des QIAcuity und der Raumwand eingehalten wird, damit eine ausreichende Belüftung des Geräts gewährleistet ist.</p> <p>Lüftungsschlitze und Öffnungen, die der Be- und Entlüftung des QIAcuity dienen, dürfen nicht abgedeckt werden.</p>

14.4 Biologische Sicherheit

Bei Substanzen und Reagenzien, die humanes Untersuchungsmaterial enthalten, sollte immer von einer möglichen Infektionsgefahr ausgegangen werden. Wenden Sie nur sichere Laborverfahren an, wie sie z. B. in Veröffentlichungen wie Biosafety in Microbiological and Biomedical Laboratories HHS, (www.cdc.gov/labs/BMBL.html) beschrieben sind.

14.4.1 Proben

Proben können infektiöse Erreger enthalten. Sie sollten sich der Gesundheitsgefahr bewusst sein, die von diesen Erregern ausgeht, und derartige Proben gemäß den erforderlichen Sicherheitsbestimmungen handhaben, lagern und entsorgen.

<p>WARNUNG</p> 	<p>Proben mit infektiösen Erregern [W9]</p> <p>Manche Proben, die mit diesem Gerät verwendet werden, können infektiöse Erreger enthalten. Gehen Sie beim Umgang mit diesen Proben mit der größtmöglichen Vorsicht und gemäß den erforderlichen Sicherheitsbestimmungen vor.</p> <p>Tragen Sie immer eine Schutzbrille, zwei Paar Laborhandschuhe und einen Laborkittel.</p> <p>Die verantwortliche Person (z. B. der Laborleiter) muss alle erforderlichen Vorsichtsmaßnahmen treffen, um sicherzustellen, dass die unmittelbare Umgebung des Arbeitsplatzes sicher ist und die Bediener des Geräts ausreichend geschult sind. Außerdem dürfen die Grenzwerte in Bezug auf infektiöse Erreger, die in den entsprechenden Sicherheitsdatenblättern (Material Safety Data Sheets, MSDS) oder den Vorschriften der OSHA*, ACGIH† oder COSHH‡ festgelegt sind, nicht überschritten werden.</p> <p>Beim Betrieb eines Abzugs und bei der Entsorgung von Abfallstoffen müssen alle Bestimmungen und Gesetze auf Bundes-, Landes- und kommunaler Ebene zu Gesundheitsschutz und Sicherheit am Arbeitsplatz eingehalten werden.</p>
---	--

* OSHA: Occupational Safety and Health Administration (Vereinigte Staaten von Amerika)

† ACGIH: American Conference of Government Industrial Hygienists (Vereinigte Staaten von Amerika)

‡ COSHH: Control of Substances Hazardous to Health (Vereinigtes Königreich)

14.5 Chemikalien

WARNUNG 	Gefährliche Chemikalien [W10] Einige Chemikalien, die mit diesem Gerät verwendet werden, können gefährlich sein oder nach Beendigung eines Protokolllaufs gefährlich werden. Tragen Sie immer eine Schutzbrille, Laborhandschuhe und einen Laborkittel. Die verantwortliche Person (z. B. der Laborleiter) muss alle erforderlichen Vorsichtsmaßnahmen treffen, um sicherzustellen, dass die unmittelbare Umgebung des Arbeitsplatzes sicher ist. Außerdem dürfen die Grenzwerte in Bezug auf toxische (chemische oder biologische) Substanzen, die in den entsprechenden Sicherheitsdatenblättern (Safety Data Sheets, SDS) oder den Vorschriften der OSHA*, ACGIH† oder COSHH‡ festgelegt sind, nicht überschritten werden. Beim Betrieb eines Abzugs und bei der Entsorgung von Abfallstoffen müssen alle Bestimmungen und Gesetze auf Bundes-, Landes- und kommunaler Ebene zu Gesundheitsschutz und Sicherheit am Arbeitsplatz eingehalten werden.
---	---

14.6 Wartungssicherheit

WARNUNG/ VORSICHT 	Gefahr von Personen- und Sachschäden [W11] Es dürfen nur Wartungsarbeiten ausgeführt werden, die in diesem Benutzerhandbuch konkret beschrieben sind.
---	--

WARNUNG 	Brandgefahr [W12] Achten Sie darauf, dass keine Reinigungsflüssigkeiten oder Dekontaminationsmittel in Kontakt mit den elektrischen Bauteilen des QIAcuity kommen.
---	---











VORSICHT 	Beschädigung des Geräts [C8] Verwenden Sie keine Bleichmittel, Lösungsmittel oder Reagenzien, die Säuren, Laugen oder Abrasivstoffe enthalten, um den QIAcuity zu reinigen.
--	--

VORSICHT 	Beschädigung des Geräts [C9] Verwenden Sie keine Sprühflaschen, die Alkohol oder Desinfektionsmittel enthalten, um die Oberflächen des QIAcuity zu reinigen.
--	---

14.7 Strahlensicherheit

WARNUNG 	Gefahr von Personenschäden Laserlicht der Gefahrenklasse 2: Schauen Sie bei Verwendung des Barcode-Handscanners nicht in den Laserstrahl.	[W13]
---	---	--------------

14.8 Symbole auf dem QIAcuity

Symbol	Ort	Beschreibung
	Typenschild an der Geräterückseite	CE-Markierung der EU-Konformität
	Typenschild an der Geräterückseite	UKCA-Markierung der UK-Konformität
	Typenschild an der Geräterückseite	Symbol der CSA-Zertifizierung in Kanada und den USA
	Typenschild an der Geräterückseite	RCM-Zeichen für Australien und Neuseeland
	Typenschild an der Geräterückseite	Markierung gemäß RoHS-Richtlinie für China (Einschränkungen in Bezug auf den Gebrauch bestimmter Gefahrstoffe in Elektro- und Elektronikgeräten)
	Typenschild an der Geräterückseite	WEEE-Markierung (Zertifizierung gemäß Richtlinie über Elektro- und Elektronik-Altgeräte) für Europa
	Typenschild an der Geräterückseite	Hersteller i. S. d. Gesetzes
	Typenschild an der Geräterückseite	Gebrauchsanweisung beachten
	Typenschild an der Geräterückseite	Siehe Kapitel Sicherheitshinweise bezüglich Risiken
	Typenschild an der Geräterückseite	Herstellungsdatum
	An der Schublade	Biologische Gefährdung – Einige Proben, die mit diesem Gerät verwendet werden, können infektiöse Erreger enthalten und dürfen nur mit Laborhandschuhen angefasst werden.

15 Appendix E – User management permissions

The table below shows all available permissions for the user management including short descriptions and technical names. These technical names are shown in audit trail details in case a user has made changes to any users or roles.

Permission	Technical name	Description
Log in [Instrument and PC software]		
Instrument	CSW_USER_LOGIN	User can login to Instrument (login and password is needed).
Suite Software	SUITE_USER_LOGIN	User can login to Suite Software (PC software) (login and password is needed).
Instrument accesses [Instrument software]		
Instrument Maintenance	CSW_INSTRUMENT_MAINTENANCE	User can update Instrument and go to Data Management, Self-Check, Servicing and Configuration.
Experiment Schedule	CSW_PLATE_EXPERIMENTSCHEDULE	User can set up dPCR parameters (priming, cycling, imaging).
Create Support Package	CSW_INSTRUMENT_CREATESUPPORTPACKAGE	User can download and upload support package.
Plates [Instrument and PC software]		
Create Plate	QIACUITY_PLATE_CREATE	User can set up dPCR parameters (priming, cycling, imaging), reaction mixes (reagents), samples (control, non-control) and create Plate layout.
All Plates		
Run Experiment	CSW_PLATE_ALL_RUN	User can run/stop an experiment and eject Plate(s) from Instrument.
Edit Plate Data	QIACUITY_PLATE_ALL_EDITDATA	User can check and edit parameters of existing Plate (dPCR parameters, Plate layout (samples, reaction mixes (reagents), controls), and mark it as primed.
Edit Analysis Data	SUITE_PLATE_ALL_EDITANALYSIS	User can change the threshold and use lasso selection on the Analysis page of all Plates to verify the accuracy of the results.

Read Plate	QIACUITY_PLATE_ALL_READ	User can search for specific Plate, see all created Plates, analyze a Plate, check details about a Plate (dPCR parameters, plate layout (samples, reaction mixes, controls)) and export Plate to CSV.
Delete Plate	SUITE_PLATE_ALL_DELETE	User can delete any Plates.
Owned plates		
Run Experiment	CSW_PLATE_OWNED_RUN	User can run/stop an experiment and eject owned Plate(s) from Instrument.
Edit Plate Data	QIACUITY_PLATE_OWNED_EDITDATA	User can check and edit parameters of owned Plate (dPCR parameters, plate layout (samples, reaction mixes (reagents), controls), and mark it as primed.
Edit Analysis Data	SUITE_PLATE_OWNED_EDITANALYSIS	User can change the threshold and use lasso selection on the Analysis page of the owned Plates to verify the accuracy of the results.
Read Plate	QIACUITY_PLATE_OWNED_READ	User can search the Plate, analyze the Plate, see all created Plates, check details about owned Plate (dPCR parameters, plate layout (samples, reaction mixes, controls)), export plate to CSV.
Delete Plate	SUITE_PLATE_OWNED_DELETE	User can delete owned Plates.
Other permissions		
Import Plate	SUITE_PLATE_OTHER_IMPORT	User can import the Plate as a ZIP file.
Export Plate	SUITE_PLATE_OTHER_EXPORT	User can export the Plate as a password protected ZIP file.
Unlock Plate	SUITE_PLATE_OTHER_UNLOCK	User can unlock locked Plate.
Set Plate Ownership	SUITE_PLATE_OTHER_SETPLATEOWNERSHIP	User can set owners of the plate.
Upload VPF	SUITE_PLATE_OTHER_UPLOADVPF	User can upload Volume Precision Factor.
Upgrade Plate	SUITE_PLATE_OTHER_UPGRADE	User can upgrade the Plate.
Create Support Package	SUITE_PLATE_OTHER_CREATESUPPORTPACKAGE	User can download and export support package for the Plate.

Create Report for Analysis	SUITE_PLATE_OTHER_CREATEREPORT	User can create and generate report using the charts and data from the Analysis of the Plate.
Sign Report	SUITE_PLATE_OTHER_SIGNREPORT	User can add signature to the report.
Delete Report	SUITE_PLATE_OTHER_DELETEREPORT	User can delete report.

Templates [Instrument and PC software]

Create Template	SUITE_TEMPLATE_ALL_CREATE	User can create new Template.
Edit Template	SUITE_TEMPLATE_ALL_EDITDATA	User can edit existing Template.
Read Template	SUITE_TEMPLATE_ALL_READ	User can read information about existing Templates and use them while creating and editing plates (if also has appropriate plate permissions). Access to all created Templates.
Delete Template	SUITE_TEMPLATE_ALL_DELETE	User can delete existing Templates.

Archive [PC software]

Plate Archiving	SUITE_PLATE_ARCHIVE_ARCHIVE	User can archive the Plate.
Archive Overview	SUITE_ARCHIVE_ARCHIVE_READ	User has access to list of archived Plates. User can see all archived Plates, search for archived Plates, check general information about archived Plate and disk space usage for the Archive in the Disk Monitor.
Restore Plate from Archive	SUITE_PLATE_ARCHIVE_ARCHIVERESTORE	User can restore archived Plates.
Delete plate from Archive	SUITE_PLATE_ARCHIVE_ARCHIVEDDELETE	User can delete any Plate from Archive.

User Management [PC software]

Read Users and Roles	SUITE_USER_ROLE_READ	User can see the list of users and the list of roles in the system.
Create and Edit Users and Roles	SUITE_USER_ROLE_CREATEANDEDIT	User can create and edit a user, and create and edit a role.
Activate and Deactivate User	SUITE_USER_ACTIVATEANDDEACTIVATE	User can activate and deactivate a user.
Delete Role	SUITE_ROLE_DELETE	User can delete existing roles in the system.

System configuration [PC software]

Registered Instruments	SUITE_SYSTEM_REGISTERINSTRUMENT	User can see list of registered instruments.
------------------------	---------------------------------	--

Manage Archive	SUITE_SYSTEM_MANAGEARCHIVE	User can edit Archive location, detach Archive, turn on/off and configure automatic archiving.
----------------	----------------------------	--

Audit Trail Configuration

View Audit Trail	SUITE_AUDITTRAIL_READ	User can see the list of Audit Trail events, search for specific event, check details of the event and export it to PDF.
------------------	-----------------------	--

Audit Trail Toogle	SUITE_AUDITTRAIL_TURNONOFF	User can turn on/off the Audit Trail (events tracker).
--------------------	----------------------------	--

16 Document Revision History

Date	Changes
October 2021	Implemented changes to support new software updates (QIAcuity Instrument Control Software [CSW] 2.0 and QIAcuity Software Suite 2.0). Added information on advanced user management (modification of sections on the Software Suite and Instrument Software). Added the new section for Audit trail. Added information on Signatures in several chapters. Added section on multiple occupancy analysis. Added new feature (21 CFR Part 11 support). Editorial and layout changes.
June 2022	Added a statement regarding the warm-up phase for ambient temperatures. Repositioned the setup information before starting the installation process using the QIAcuity Setup Wizard. Added statement to use the IP address of the Suite Server to connect to the server. Replaced the outband TCP port with 4 inbound TCP ports for communication with QIAcuity Software Suite. Added a reminder to ensure the cable is properly connected to a laptop and the Instrument or a network before starting the repair function. Revised the note for the "Unlocking plate" function. Added exposure recommendations regarding RFU values. Added a troubleshooting point for fetch errors while accessing the Users list in User Management. Updated QIAcuity Software Suite installation, upgraded procedure, and included information about an optional data backup during the software upgrade. Implemented changes to support new software updates (QIAcuity Instrument Control Software [CSW] 2.1 and QIAcuity Software Suite 2.1). Added information on new user management with ability to add new roles with customized permissions and optional user password expiration. Added new section about an alternative method for CNV analysis based on reference targets not using dedicated reference sample in addition to the existing method based on reference samples. Updated the section describing 1-D scatterplots to reflect changes made in the way, partitions are analyzed to create 1-D scatterplots for 26k Nanoplates. Described changes made to the audit trail event tracking and usability improvement to view audit trail status in the status line of the Software Suite. Updated information about plate ownership handling and related permissions. Added information how to search plates by barcode. Included descriptions for report improvements, such as the option for a report comment and additional information shown in a report. Described changes made to the RFU export and data export file. Added information about new Nanoplate supported and updated section about dust detection.
November 2022	Included the UKCA symbol. Added more details on the storing conditions for plate seals and reimaging of plates. Updated recommended browser versions. Added recommendations for firewall and antivirus settings.

Limited License Agreement for QIAcuity

Use of this product signifies the agreement of any purchaser or user of the product to the following terms:

1. The product may be used solely in accordance with the protocols provided with the product and this handbook and for use with components contained in the kit only. QIAGEN grants no license under any of its intellectual property to use or incorporate the enclosed components of this kit with any components not included within this kit except as described in the protocols provided with the product, this handbook, and additional protocols available at www.qiagen.com. Some of these additional protocols have been provided by QIAGEN users for QIAGEN users. These protocols have not been thoroughly tested or optimized by QIAGEN. QIAGEN neither guarantees them nor warrants that they do not infringe the rights of third-parties.
2. Other than expressly stated licenses, QIAGEN makes no warranty that this kit and/or its use(s) do not infringe the rights of third-parties.
3. This kit and its components are licensed for one-time use and may not be reused, refurbished, or resold.
4. QIAGEN specifically disclaims any other licenses, expressed or implied other than those expressly stated.

The purchaser and user of the kit agree not to take or permit anyone else to take any steps that could lead to or facilitate any acts prohibited above. QIAGEN may enforce the prohibitions of this Limited License Agreement in any Court, and shall recover all its investigative and Court costs, including attorney fees, in any action to enforce this Limited License Agreement or any of its intellectual property rights relating to the kit and/or its components. For updated license terms, see www.qiagen.com.

Trademarks: QIAGEN®, Sample to Insight®, QIAcuity®, QIAgility® (QIAGEN Group); RNaseZap® (Ambion, Inc.); DNA-ExitusPlus™ (AppliChem); EvaGreen® (Biotium, Inc.); Cy® (GE Healthcare); Windows® (Microsoft Corporation); Texas Red® (Molecular Probes, Inc.); Lysetol®, MikroZid® (Schülke & Mayr GmbH); FAM™, HEX™, ROX™, TAMRA™, VIC® (Thermo Fisher Scientific or its subsidiaries); DECON-QUAT® (Veltek Associates, Inc.). Registered names, trademarks, etc. used in this document, even when not specifically marked as such, are not to be considered unprotected by law.

11/2022 HB-2717-005 © 2022 QIAGEN, all rights reserved.

